



**Generic Software
Release Notes
V5.1 FSR00 PUN00**

61220300051-02P

NOTE: This equipment has been tested and found to comply with the limits for a Class A digital device pursuant to Part 15 of FCC Rules. These limits are designed to provide reasonable protection against harmful interference when this equipment is operated in a commercial environment. This equipment generated, used, and can radiate radio frequency energy and, if not installed and used in accordance with the instruction manuals, may cause interference in which case the user will be required to correct the interference at his/her own expense.

NOTICE: Customers connecting this device to the network shall, upon request of the telephone company, inform the telephone company of the particular lines such connections are made, the FCC registration number, and ringer equivalence number of this device. This information is contained on the label located on the rear panel of the system.

If this device causes harm to the network, the telephone company may discontinue your service temporarily. If possible, they will notify you in advance. But if advance notice isn't practical, you will be notified as soon as possible. You will be advised of your right to file a complaint with the FCC.

Your telephone company may make changes in its facilities, equipment, operations, or procedures that could affect the proper operation of your equipment. If they do, you will be notified in advance to give you the opportunity to maintain uninterrupted service.

If you experience trouble with the system, please contact Summa Four, Inc., 25 Sundial Avenue, Manchester, NH 03103-7251, (800) 978-6624 for repair information. The telephone company may ask you to disconnect this equipment from the network until the problem has been corrected, or you are sure that the equipment is not malfunctioning.

This equipment may not be used on coin service provided by the telephone company. Connection to party lines is subject to state tariffs.

Copyright © 1998 by Summa Four, Inc.

P/N 61220300051-02P

Preliminary: 09.30.98

Summa Four, Inc. reserves the right to change specifications without prior notice.

For further information about this product, contact:

Summa Four Inc.
25 Sundial Avenue
Manchester, NH 03103-7251
(800) 978-6624

Printed In U.S.A.



This symbol on the product's nameplate means it has been tested by Electronic Testing Labs, Inc.

Table of Contents

SECTION 1 – INTRODUCTION

1.1 INTRODUCTION TO GENERIC V5.1	1-1
1.2 4K PORT CAPABILITY	1-1
1.3 SUMMARY OF NEW FEATURES	1-2
1.4 SUMMARY OF RECOMMENDED STEPS FOR PERFORMING V5.1 TEST	1-3
1.5 REFERENCES	1-4

SECTION 2 – NEW FEATURES

2.1 EXTENDED HOST API	2-1
2.2 INCREASED SYSTEM LIMITS	2-4
2.2.1 Inpulse/Outpulse Rules	2-4
2.3 EXTENDED OPERATIONAL MODE	2-4
2.3.1 Set Extended Operational Mode Option	2-5
2.3.2 Extended Operational Mode Verification Flag	2-5
2.4 OPERATIONAL MODE REPORTING	2-6
2.5 4K PORT CONFIGURATION	2-7
2.5.1 C-Bus Enabled Mode	2-7
Installation Utilities Menu	2-8
Administrator Main Menu Screen	2-8
System Features Screen	2-9
2.5.2 VCO 4K Series Label	2-10
2.5.3 Card Type Attributes	2-10
2.6 INTERFACE CONTROLLER CARD	2-10
2.6.1 ICC Programmable Trunk Configuration Screen	2-10
2.6.2 Valid Signaling Protocols	2-12
2.6.3 ICC and SNMP	2-12
2.6.4 ICC E1 and ISDN NET5	2-12
Software Download	2-12
System Administration Changes	2-13
\$A8/04 Command	2-14
ICC E1 ISDN NET5 Restrictions	2-16
SNMP and ICC ISDN NET5	2-16
2.7 SERVICE PLATFORM CARD	2-16
2.7.1 SPC DTMF Reception	2-16
2.7.2 SPC Conferencing	2-17
2.7.3 SPC-MFCR2	2-17
2.7.4 SPC-CPA	2-17
2.7.5 SPC Outpulsing	2-17
2.7.6 SPC-MFR1	2-18

Table of Contents

2.8	TIMESLOT ALLOCATION LICENSING INCREASE	2-18
2.8.1	License Configuration Screen Modification	2-18
2.9	REDUNDANCY ENHANCEMENTS	2-19
2.9.1	Modify Initialization of Subracks	2-19
2.9.2	Eliminate Redundancy Messages for Empty Conferences	2-19
2.9.3	Flow Control for Update Channel	2-20
2.10	SYSTEM ADMINISTRATION ENHANCEMENTS.....	2-20
2.10.1	Add/Delete Type 2 Cards by Span	2-20
2.10.2	Start Number Field	2-20
2.10.3	Extended "Slot" Field	2-21
2.10.4	Propagate Port Parameters	2-23
2.10.5	Change Card Status For Multi-span Cards	2-23
2.11	MISCELLANEOUS SOFTWARE ENHANCEMENTS	2-23
2.11.1	Turbo NBC Download	2-23
2.11.2	MFCR2 Enhancement for Outpulsing Different Categories	2-23
2.11.3	ASIST	2-24
2.11.4	SNMP	2-24
2.12	MASTER CONSOLE MESSAGES	2-25
2.12.1	New Error Messages	2-25
2.12.2	Error Messages Previously Restricted to Card Maintenance Screen	2-26
2.12.3	Messages Added to Card Maintenance Screen	2-26
2.12.4	Messages Deleted From Card Maintenance Screen	2-26
2.13	4K PORT RESTRICTIONS	2-26
2.13.1	IPRC Record Function Disabled	2-26
SECTION 3 – SYSTEM REQUIREMENTS		
3.1	HARDWARE REQUIREMENTS.....	3-1
3.2	FIRMWARE REQUIREMENTS	3-2
3.3	SOFTWARE REQUIREMENTS	3-6
SECTION 4 – INSTALLING V5.1 SOFTWARE		
4.1	INTRODUCTION.....	4-1
4.2	OVERVIEW OF THE INSTALLATION PROCEDURE.....	4-1
4.3	WHAT YOU NEED	4-2
4.4	INSTALLING THE SOFTWARE	4-3
4.4.1	Installing the Generic Software	4-3
4.4.2	Performing a Database Conversion	4-5
4.4.3	Installing Ethernet for Host and SNMP Communication	4-6

Table of Contents

4.5	INSTALLING THE SOFTWARE ON THE B-SIDE	4-9
4.5.1	Verifying File Synchronization	4-9
4.6	SNMP	4-9
4.6.1	Installing the MIB Software	4-9
4.6.2	Setting up snmptalk	4-10
4.6.3	Public Access	4-10
4.7	SETTING EXTENDED OPERATIONAL MODE	4-11
4.8	RESETTING TO STANDARD MODE	4-11
4.9	ENABLE C-BUS	4-11
 SECTION 5 – LIVE UPGRADE PROCEDURE		
5.1	INTRODUCTION	5-1
5.2	PREPARE FOR LIVE UPGRADE	5-2
5.3	LIVE UPGRADE ACCESS	5-4
5.4	LIVE UPGRADE PROCEDURE OVERVIEW	5-5
5.5	PERFORM A LIVE UPGRADE	5-6
5.5.1	Step 1: Prepare for Installation of New Release	5-6
5.5.2	Step 2: Back up the Existing Database	5-7
5.5.3	Step 3: Install the New Software	5-8
	Install from Floppy Diskettes	5-8
	Install Optional Software	5-10
	Install from Another Host	5-11
5.5.4	Step 4: Prepare for the Upgrade	5-11
5.5.5	Step 5: Enable/Disable/Configure Optional Software	5-12
5.5.6	Step 6: Update the Generic Software	5-13
	Update the CPU	5-13
	Update the NBC-3 Card	5-14
	Update the DTG-2 Card	5-14
	Database Conversion	5-14
5.5.7	Step 7: Switch the Active Side to Standby	5-15
5.5.8	Step 8: Prepare to Upgrade the Remaining Side	5-15
5.5.9	Step 9: Enable/Disable/Configure Optional Software	5-16
5.5.10	Step 10: Update the Generic Software	5-16
	Update the CPU	5-17
	Update the NBC-3 Card	5-17
	Update the DTG-2 Card	5-18
	Database Conversion	5-18
5.5.11	Verifying File Synchronization	5-18
5.5.12	Step 11: Cutover of Port and Service Cards	5-19
	Field Definitions: Display Only	5-20
	Field Definitions: Data Entry	5-21

Table of Contents

5.5.13 Step 12: Back Up the New Database	5-22
5.5.14 Step 13: Cleanup	5-22
5.5.15 Prompts, Warnings, and Error Messages	5-23
Prepare for Install Messages	5-23
Installing New Software Messages	5-23
Prepare for Upgrade Messages	5-24
Enable/Disable/Configure Optional Software Messages	5-25
Card Cut-Over Messages	5-26
General Live Upgrade Messages	5-27

SECTION 6 – KNOWN DESIGN CONSTRAINTS

U803300005: Field Limitation for Inpulse/Outpulse Rules	6-1
Drop and Insert Card Not Supported in C-bus Mode	6-1
SNMP Walk Freezes	6-1
MVDC T1 Not Supported in C-bus Mode	6-1
ICC Requires Reboot After Download	6-1

SECTION 7 – KNOWN FUNCTIONAL CONSTRAINTS

7.1 INTRODUCTION	7-1
7.2 SYSTEM ADMINISTRATION	7-2
Database Conversion Error Reported	7-2
U507315162/TR 5162: No Automatic Database Conversion	7-2
U508295234/TR 5234: Adding Cards to End of Configured Database	7-2
U512071001: Aux1 Alarm Not Set on System Alarms Display Screen	7-2
U604041001: IPRC Voice Prompt Maintenance	7-2
U605010004: Keyboard Type is Reset During System Reboots	7-3
U611260002: Abort Button	7-3
U704100002: No Error Logged Upon Failure	7-3
U705050001: FTP Quote Command Inconsistent	7-3
U705050002: FTP Quote Join Command Error	7-3
U802020002: Large Trace Files Can Not Be Deleted	7-4
U802060004: Prompt Library Not Working Properly	7-4
7.3 SYSTEM CONFIGURATION UTILITIES	7-4
U411304788/TR 4788: Viewing Software Configuration on Floppy Disks	7-4
7.4 SPECIAL REDUNDANT SYSTEMS CONSIDERATIONS	7-4
U606190001: System Host Configuration Update Problem	7-4
U701290006: DVC \$9 Timeout on Transfer to Standby	7-4
U801300003: Mismatched Timeslot Allocation Numbers	7-5
U808200004: Update Channel Failure	7-5

Table of Contents

7.5	DISK OPERATIONS	7-5
	U409224673/TR 4673: Database Utility Covers File Access Errors	7-5
	U505035026/TR 5026: Formatting a Floppy During Reboot	7-5
	U604121001: Mismatch Between On-line and Diskette Disk Utilities	7-5
	U801170001: System Crashes When Reading Incorrectly Labeled Floppy Disk	7-6
7.6	DIGIT COLLECTION	7-6
	TR 2274: Single Digit Collections (8-Port DTMF Cards Only)	7-6
	U507315157/TR 5157: Garbled MF Digit Reports Not Sent to Host	7-7
7.7	INPULSE/OUTPULSE RULE PROCESSING	7-7
	U503234961/TR 4961: RELEASE Inpulse Rule Requires Resource Type	7-7
	U608140005: RELEASE DTG Token Does Not Work	7-7
	U806250001: Inpulse Rules Aborting on Port \$47F	7-7
7.8	CALL PROCESSING	7-7
	U407064606/TR 4606: DASS Ports Stuck in MAINT-NE State	7-7
	U410264726/TR 4726: After Switchover, SLIC OGT Keeps Ringing	7-8
	U503284968/TR 4968: Disconnect Fails Unless Port Goes Through Stable	7-8
	U505085035/TR 5035: Multiple Host and High Load Causes System Failure	7-8
	U505115041/TR 5041: Interval Between Seizure and Wink	7-8
7.9	COMMAND/REPORT PROCESSING	7-8
	U507315159/TR 5159: Appending Digits via the \$67 Command	7-8
	U507315160/TR 5160: Number of Digits to Collect (\$67 Command)	7-8
	U507315161/TR 5161: Inpulse Rule Complete (\$DD) Report Processing	7-9
	U508175187/TR 5187: \$67 Command and Inpulse Rule—Digit Collection	7-9
	U603210001: NSB \$02 Returned for \$65 and \$49 Commands	7-9
	U803150002: NSB \$23 Returned for \$65	7-9
	U808280002: \$83 Report is Incorrect In Extended Mode	7-9
	U809210002: \$DD Rule Status Byte Not Initialized in Extended Mode	7-9
7.10	INITIALIZATION	7-10
	U311104202/TR 4202: System Sends \$DC Report too Early	7-10
7.11	DTG AND DTG-2	7-10
	U610020003: DTG/DTG-2 Add/Delete During Outpulsing	7-10
	U703120001: Deleting a DTG from the Database Stops Outputting	7-10

Table of Contents

7.12	FOUR SPAN CARDS	7-10
	U507185123 (formerly U507201007): Processing WINK Command	7-10
	U603151001: Inconsistent Handling of Channels on Four Span E1	7-11
	U604260001: Testing Patterns from TTS-3 Analyzer Causes Errors	7-11
	U606101001: MVDC T1s/Four Span T1s Generate FRM90 Before Download	7-11
	U606241001: Four Span T1/E1 Internal Errors During Boot	7-11
	U611140005: Four Span T1 on Switchover Not Performing Correctly	7-12
	U611250003: FRM523 Queue Overflow	7-12
	U611260001: Rotary Resource Group	7-12
	U704140004: Display ACTIVE while Downloading	7-12
	U710290005: MVDC T1 Fails to Clear Alarms	7-12
	U710300008: Aborted Download Does Not Resume After Switchover	7-12
	U710310001: Display Card Data Screen Not Recording Slips	7-12
7.13	INTERFACE CONTROLLER CARD (ICC)	7-13
	U803040001/802260013: ICC E1 Spans Reporting FRM113	7-13
	U803150001: Blue Alarms Received on ICC E1	7-13
	U808270002: ICC-E1 and D+I Does Not Work When Set For Mu-law	7-13
	U808270003: ICC-T1 Clear Channel Does Not Work	7-13
7.14	SERVICE PLATFORM CARD (SPC)	7-13
	U809240004: SPC Without SRM Installed Displays in Maintenance Mode	7-13
	U804300003: SPC Fails Multi-field DTMF Collection	7-13
	U806230005: SPC Goes OOS When Running a DTMF T1/E1 Load	7-13
	U806300002: SPC-CPA Sensitive to DTMF Digits	7-14
	U806300007: Error Opening Specs File	7-14
	U806300008: Tone Tests Failure	7-14
	U806300009: SPC-DTMF Fails Multi-field Collection	7-14
7.15	MISCELLANEOUS CARD ISSUES	7-14
	U409124662/TR 4662: UTC Firmware Causing T1 INIT Code F Error	7-14
	U505105038/TR 5038: Reorder Tone is Not Reported/Detected (UK)	7-14
	U603021003: IPRC Load Problems with More than 22 Seizures	7-14
	U609230005: Outgoing T1 Stuck in CP_OUTPUL	7-15
	U808040004: SSC Downloads and Goes Into Maintenance State	7-15
	U809080001: SSC Shows Incorrect Port Address	7-15
7.16	MULTIPLE HOST CONNECTIONS	7-15
	U605091001: Major Alarm Not Set on Loss of Hosts	7-15
7.17	TELEROUTER	7-15
	U606041001: TeleRouter \$D5 (Routing Action) Reports	7-15

Table of Contents

7.18 SIMPLE NETWORK MANAGEMENT PROTOCOL (SNMP)	7-16
Functions Not Supported	7-16
U608130005: SNMP Resource Group Configuration Problem	7-16
U708140005: D+I Card Not Supported Via SNMP	7-16
7.19 ETHERNET	7-16
U608080006: Problem with Ethernet Install	7-16
7.20 ISDN ISSUES	7-17
U401054297/TR 4297: ISDN Ports Remain in DISC_REQ State	7-17
7.21 INTERNATIONAL ISSUES	7-17
U505125048/TR 5048 Chile CPA Does Not Detect Tones	7-17
U505155052/TR 5052: Finland CPA Does Not Detect Tones	7-17
U505255069/TR 5069/TR 5068: Colombia CPA Intermittent Tone Detection	7-17
U508075168/TR 5168: Multiple MFCR2 Cards with Colombia V19.02	7-17
 APPENDIX A – APPENDIX A – Replacing PROMs and PLDs	
A.1 INTRODUCTION	A-1
A.2 REMOVING and REPLACING THROUGH-HOLE PROMs and PLDs	A-1
A.3 REMOVING AND REPLACING SURFACE-MOUNT PROMs and PLDs	A-3

List of Figures

Figure 2.1: Installation Utilities Screen	2-5
Figure 2.2: Extended Operational Mode Verification Flag.....	2-6
Figure 2.3: Installation Utilities Screen	2-8
Figure 2.4: Administrator Main Menu Screen	2-9
Figure 2.5: C-bus Mode Verification Flag	2-9
Figure 2.6: ICC Programmable Trunk Configuration Screen	2-11
Figure 2.7: PRI Card Configuration Screen	2-13
Figure 2.8: SA8/04 Message Format	2-14
Figure 2.9: License Configuration Screen.....	2-19
Figure 2.10: Inpulse Rules Screen.....	2-21
Figure 2.11: Slot/Group/Span Field Display	2-22
Figure 2.12: MIB Changes.....	2-25
Figure 4.1: Installation Utilities Menu.....	4-4
Figure 4.2: Ethernet Installation Utilities Menu	4-6
Figure 4.3: Ethernet Configuration Menu	4-7
Figure 5.1: Live Upgrade Control Menu.....	5-4
Figure 5.2: Upgrade Process Directory Structure	5-7
Figure 5.3: VCO Installation Screen	5-8
Figure 5.4: VCO Floppy Installation Screen.....	5-9
Figure 5.5: Install from Floppy Screen	5-10
Figure 5.6: Enable/Disable/Configure Optional Software Screen	5-12
Figure 5.7: Card Cut-Over Screen.....	5-20
Figure A.1: Aligning PROM or PLD Pins	A-2
Figure A.2: Notch Orientation for IC	A-2
Figure A.3: Inserting Pins on One Side of Socket.....	A-2
Figure A.4: Inserting Pins on Other Side of Socket	A-3
Figure A.4: PROM/PLD Alignment	A-4

List of Tables

Table 1.1: System Feature Compatibility	1-2
Table 2.1: Host Command Message Changes	2-2
Table 2.2: Host Report Message Changes	2-3
Table 2.3: Host Command/Report Messages Not Changed	2-3
Table 2.4: System Limits	2-4
Table 2.5: SA8/04 ISDN Span Configuration Parameters	2-15
Table 3.1: Common Firmware Requirements	3-2
Table 3.2: North American Firmware Requirements	3-5
Table 3.3: V5.1 Software Requirements	3-6
Table 4.1: snmptalk Setup Commands	4-10
Table 5.1: Live Upgrade Procedure Overview	5-5

List of Tables

Section 1 INTRODUCTION

1.1 INTRODUCTION TO GENERIC V5.1

Generic V5.1 is the system software that takes advantage of the 4,096 (4K) port capacity in Summa Four's VCO/4K switch. Generic V5.1 requires a software and hardware upgrade to your current VCO switch: the V5.1 software included with this shipment must be installed in your switch, and a C-bus retrofit kit hardware upgrade is required (if not already installed) in order to operate your VCO in 4K mode.

In addition, you may need to upgrade some of your existing Summa Four cards to the current firmware requirements. Refer to *Section 3, System Requirements*, for these requirements.

New systems shipped with V5.1 software have all generic and download files installed on the system's hard drive, and current Summa Four cards installed in the switch. If you need to re-install the software files, you must install all files from the six V5.1 diskettes onto the hard drive as outlined in *Section 4*. If you are upgrading to V5.1, you must install all files from the six V5.1 diskettes onto the hard drive as part of the overall upgrade steps outlined in *Section 4*.

Refer to *Section 5* for instructions on upgrading to V5.1 with the Live Upgrade feature.

NOTE: To upgrade current system software to Generic V5.1, Generic V4.2 FSR00 or greater is required. If you are currently running V3.3.05 or V3.3.06, you must perform a two-stage upgrade: upgrade from V3.3.xx to V4.2.00, then from V4.2.00 to V5.1. A database conversion is required for each upgrade. Refer to Generic V4.2 Release Notes for possible upgrade restrictions.

Call Summa Four at 1-800-978-6642, or 1-603-695-1293, if you are running a version of the generic software prior to 4.2.00.

1.2 4K PORT CAPABILITY

To take advantage of the 4K port capability, an extended Host API has been developed; the Host API command and report fields have been extended, and additional fields have been added. The extended Host API is designed for messages to handle the 4,096 address range and tone plan identification. The extended Host API is required for the switch to operate in extended operational mode. This extended version of the API also supports the existing 2,048 port configuration with existing hardware.

Systems can operate with either the standard (existing) version of the Host API or the extended API. The switch must be set to operate in one mode or the other. The method for setting and viewing the mode is specified in *Section 2*.

Generic V5.1 can run on VCO/Series or SDS switches, but only VCO/Series switches can use all 4,096 timeslots. The C-bus hardware is installed on VCO/4K systems at the time of manufacture; VCO/20 and VCO/80 systems may be upgraded with an optional upgrade kit.

Table 1.1 System Feature Compatibility

System Feature	VCO/20	VCO/4K	VCO/80	SDS
2,048 ports	Yes	Yes	Yes	Yes
4,096 ports ^a	Yes ^b	Yes	Yes ^b	No
Standard operational mode	Yes	Yes	Yes	Yes
Extended operational mode	Yes	Yes	Yes	Yes
A- and B-bus	Yes	Yes	Yes	Yes
C-bus	Yes ^b	Yes	Yes ^b	No

^a To take advantage of the 4,096 ports, enable both the Extended Operational Mode and C-bus Enabled System Feature flags.
^b With optional upgrade kit.

1.3 SUMMARY OF NEW FEATURES

New features in the Generic V5.1 software release and 4K system include:

- Extended Host API
- Increased system limits
- Extended operational mode (4,096 timeslots)
- Operational mode reporting
- 4K port configuration
- Interface Controller Card (ICC)
- Service Platform Card (SPC)
- Timeslot allocation licensing increase
- Redundancy enhancements
- System administration enhancements

Detailed information for each above mentioned feature, and screen layouts when applicable, are provided in *Section 2*.

1.4 SUMMARY OF RECOMMENDED STEPS FOR PERFORMING V5.1 TEST

To upgrade your system to V5.1 FSR00 the following steps are recommended:

1. Verify system requirements and make any required firmware changes (*Section 3*).
2. Back up your current database.
3. On side A:
 - a. Perform incremental installation of generic software (*Section 4.4.1*).
 - b. Perform a database conversion (*Section 4.4.2*).
 - c. Install Ethernet for Host and SNMP Communication (*Section 4.4.3*).
4. For redundant systems, repeat steps 3.a through 3.c on side B.
5. If running SNMP, install MIB on the network management system (*Section 4.6.1*).
6. Test the system with your existing application in Standard Operational Mode.
7. Back up the database(s).
8. Bring down the switch and set the system to Extended Operational Mode (*Section 4.7*).
NOTE: At this point the application should also be switched to send and receive the Extended Host API.
9. Test the system in Extended Operational Mode.
10. To return to standard mode, the saved database files must be used (*Section 4.8*).

CAUTION: If running a redundant system, set both sides to the same mode.

1.5 REFERENCES

You may want to refer to the following documents that apply to your configuration.

- SDS and VCO *Installation Manual*
- Technical Description: *Interface Controller Card (ICC)*
- Technical Description: *Interface Controller Card I/O Module*
- Technical Description: *Service Platform Card (SPC)*
- Technical Description: *Central Processing Unit (CPU - 16 MB 68030)*
- Technical Description: *Network Bus Controller 3 (NBC-3) Card*
- Product supplements for optional software, including:
 - *VCO V4.1 Management Information Base (MIB) Reference Guide*
 - *VCO V4.1 Management Information Base (MIB) User's Guide*
 - *V4.0 VCO & SDS Programming Reference*
 - *V5.0 Extended API Programming Reference*
 - *V5.0 Standard and Extended ASIST/API Programming Reference*
 - *V4.0 TeleRouter Reference Guide*
 - *V4.0 ISDN Supplement*
 - *V4.0 Ethernet Supplement*
 - *V4.2 DPNSS Supplement*
 - *V4.2 DASS2 Supplement*
 - *V4.0 IPRC Supplement*
 - *V4.2 ISDN NET5*
 - *V4.0 Applicable country supplements*

Section 2

NEW FEATURES

2.1 EXTENDED HOST API

The Extended Host API is designed for messages to handle the 4,096 address range and tone plan identification. The host interface supports both the Standard and Extended Host API. The Extended Host API is required for the increased system limits, and is used when the switch is in Extended Operational Mode.

The major functional modifications included in the Extended Host API include:

- Port Addresses — 4 bytes, bit packing removed
- Resource Group IDs — 2 bytes
- Impulse/Output Rule IDs — 2 bytes, bit packing removed
- Conference Call ID — 2 bytes
- Address Ranges — 4 bytes

Additional field modifications include:

- Spacer Bytes — 4 bytes for User Function ID in commands
Use as a command or ID tag field. The echoed command response contains the value contained in the spacer bytes for the command.
- Tone Plans — 4 bytes

NOTE: Refer to the Extended API Programming Reference for more information.

The following tables display the differences between the standard and extended versions of the host messages.

Table 2.1 Host Command Message Changes

ID	Command	Spacer Byte	Tone Plan	Port	Group	Rule
\$49	ISDN Port Control	X	X	X		
\$65	Subrate Port Control	X	X	X		
\$66	Voice Path Control	X		X		
\$67	DTMF Collection Control	X	X	X	X	
\$67	DTMF Collection Enhanced	X	X	X	X	
\$68	MF Collection Control	X	X	X	X	
\$69	Outgoing Port Control	X	X	X	X	X
\$6A	Incoming Port Control	X	X	X		X
\$6B	Change Incoming Port	X	X	X	X	
\$6C	Voice Port Control	X	X	X	X	
\$6C	Voice Port Enhanced	X	X	X	X	
\$6D	Conference Control	X	X	X	Conf #	
\$70	Port Hook State Control	X	X	X		X
\$72	Port Supervision Control	X	X	X		
\$80	Request Resource Allocation			X	X	
\$81	Req. Hardware Allocation			X		
\$83	Port Status Command			X		
\$90	Change Port Status Cmd	X		X		
\$91	Voice Prompt Maintenance	X	X	X		
\$C0 02	Configure T1 Sync			X		
\$C0 05	Host Assume/Relinquish			X		

Table 2.2 Host Report Message Changes

ID	Report	Port	Group	Rule
\$80	Resource Allocation	X	X	
\$81	Hardware Allocation	X		
\$82	Card Status Command	X		
\$83	Port Status Command	X		
\$D0	MF Digit	X		
\$D1	DTMF Digit Enhanced	X		
\$D2	Permanent Signal Condition	X	X	
\$D3	System Port Status	X	X	
\$D5	Routing Action (TeleRouter)	X		
\$D6	Resource Limitation	X	X	
\$D9	System Card Status	X		
\$DA	Outgoing Port Change State	X	X	
\$DB	Incoming Port Change State	X	X	
\$DD	Inpulse Rule Complete	X		X
\$DE	Voice Port Status	X		
\$EA	ISDN Port Change of State	X		X
\$ED	ISDN Impulse Rule Compl.	X		X

Table 2.3 Host Command/Report Messages Not Changed

ID	Command
\$82	Card Status Command
\$C0 00	Config VCA/Set Sys Clock
\$C0 01	Change Active Controllers
\$C0 03	Set/Reset Host Alarms
\$C0 04	Host Call Load Control
\$F0	Alarm Condition

2.2 INCREASED SYSTEM LIMITS

Generic V5.1 features increased system limits for inpulse and outpulse rules, resource groups, maximum ports in a resource group, and virtual ports. *Table 2.4* lists the resource and maximum system limits.

Table 2.4 System Limits

System Resource	Old Limit	New Limit
Inpulse Rules	30	255
Outpulse Rules	30	255
Resource Groups	63	224
Max. Ports in a Resource Group	999	1920
Virtual Ports	256	999

NOTE: The increased system limits do not apply when your system is operating in standard mode.

2.2.1 Impulse/Outpulse Rules

To effectively utilize the increased impulse and outpulse rule limits in extended operational mode, a database conversion is required. The database conversion removes any invalid tokens that may exist in the table, clears random bits, and removes valid tokens that may be in an invalid position in the rule.

2.3 EXTENDED OPERATIONAL MODE

To take advantage of the increased system limits, a menu option, Set Extended Operational Mode, has been added to the Installation Utilities screen. This screen, shown in *Figure 2.1*, appears during the installation process.

The Extended Host API is required to use the full 4,096 ports. Refer to *Section 2.1* for detailed information on Extended Host API.

2.3.1 Set Extended Operational Mode Option

Extended Operational Mode requires an addition to the Installation Utilities screen as shown in *Figure 2.1*. Select **7** for the new Set Extended Operational Mode option.

CAUTION: Extended Operational Mode is not backward compatible. To revert to standard mode you must restore a saved or empty database.

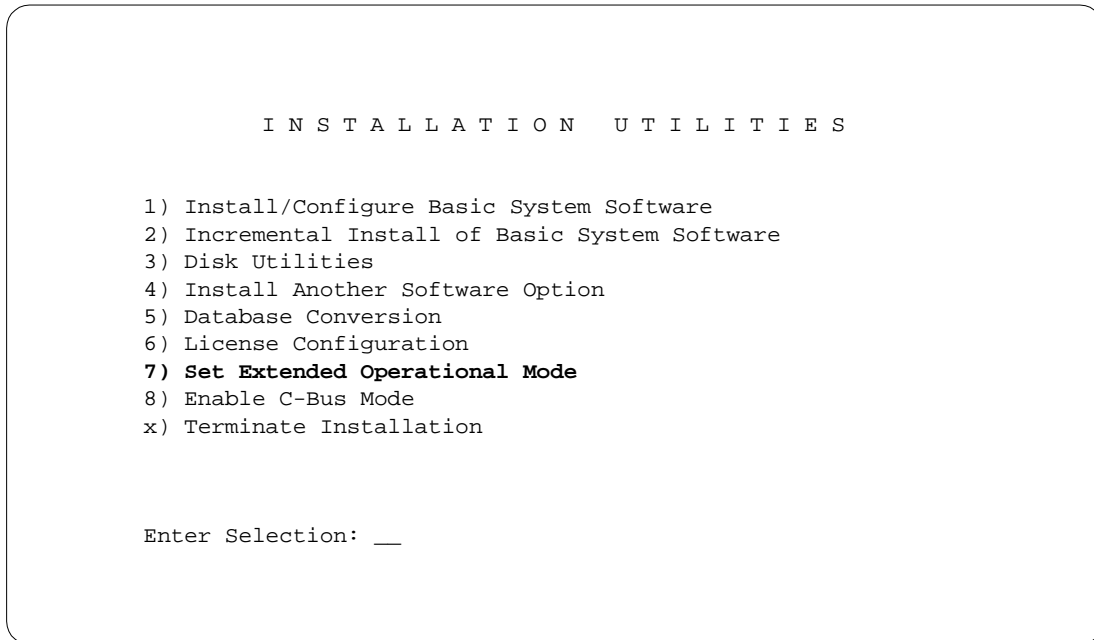

TP000005

Figure 2.1: Installation Utilities Screen

When selected, a Setting the Operational Mode To Extended Mode. Are you sure(Y/N)=N? prompt displays on the screen. If unsure, press **ENTER**. Otherwise, press **Y** then **ENTER** to continue. Once activated, an Extended Mode of Operational is Set Now message appears.

If the system is already in Extended Operational mode, when you press **7** an Already in Extended Mode message appears.

NOTE: Change both sides in a redundant system.

2.3.2 Extended Operational Mode Verification Flag

An Extended Operational Mode flag is added to the System Features screen, as shown in *Figure 2.2*. This flag is read-only and shows whether Extended Operational Mode is activated. If Y, the Extended Operational Mode is used. If N, the Standard Operational Mode is used.

S Y S T E M F E A T U R E S			
FEATURES	ALLOWED (Y,N)	FEATURES	ALLOWED (Y,N)
Redundant System	N	Send All ISDN Connect Reports	N
Output Periodic Alarm Reports	N	Enable \$66 Cmd Host Checking	N
Card/Alarm Status at Init.	N	Cut Thru For Non-ISDN Alerting	N
Manual Intervention For SLIP/OOF	N	Enable 4th Column DTMF	N
Enable Grace Timing On Null Rule	N	Set System to A-Law	Y
Disable Card Error Report/Reset	N	Enable AllPortsDeactivated Alarm	N
Enable Digit Field Reporting	N	\$EA Reports on DChannel RESTART	N
Suppress PSC/Rule Abort Messages	N	Enable NET5 Overlap Receiving	N
Enable Host Password Check	N	Send All ISDN Disconnect Report	N
Force Bearer/Lap Activation	N	Convert Reorder Tone To Busy	N
Enable MFC-R2 Supervised Clear	N	K1197 Layer 3 Testing	N
Enable SLIC Guarded Disconnect	N	Extended Operation Mode Set	N
Enable CPA Monitor Disconnect	N	C-bus Mode Enabled	N
Revert to Basic Redundancy	N		
Send Reports Before Guard Time	N		
Enable ISDN Manual Disconnect	N		

TP000088

Figure 2.2: Extended Operational Mode Verification Flag

2.4 OPERATIONAL MODE REPORTING

The \$DC report is generated each time the host connects and each time a switchover occurs. This report has been enhanced to indicate the operational mode in which the system is running: standard or extended. The third bit, formerly reserved, now represents the operational mode.

Refer to the *System Reports* section of the *Extended API Programming Reference* for detailed information. This documentation is provided on CD-ROM as part of your V5.1 shipment.

2.5 4K PORT CONFIGURATION

The vehicle for providing the additional port capability for a 4K port configuration is the C-bus. The C-bus provides the additional 2,048 timeslots, for a total of 4,096 timeslots. Systems configured with only A- and B-buses are limited to 2,048 (2K) timeslots.

The backplane of a 2K port switch being upgraded to a 4K port switch must be physically augmented to enable the C-bus. A C-bus retrofit kit is included in the V5.1 upgrade shipment, if necessary.

NOTE: VCO/4K systems are shipped with the 4K port backplane installed.

In addition, the Alarm Arbiter Card (AAC), with a revision of COUR or later, is required. The system controller requires the 16MB 68030 CPU. Refer to the *Central Processing Unit* technical description for detailed information.

To operate in 4K mode, Type 2 cards are required. Type 2 cards are compatible with the C-bus, and are designated as Type 2 by the IV K label on the front panel of the card.

NOTE: Refer to Table 1.2 in Section 1 of the System Administrator's Guide for the attributes of all available Summa Four cards.

All cards must be situated in a single switch subrack. This is required because the Bus Repeater Card (BRC) is not able to carry the C-bus.

NOTE: To utilize the 4K timeslots, your system may need a hardware upgrade. Follow these guidelines: The VCO/4K is configured at the factory at the time of manufacture. The VCO/20 can be upgraded in the field. The VCO/80 can be upgraded in the field, but can use only one switch subrack. The SDS/Series does not support 4K; it is restricted to 2K port operation.

2.5.1 C-Bus Enabled Mode

To take advantage of the increased number of timeslots, you must enable the C-bus from the Installation Utilities screen. This screen appears during the installation process. To use the C-bus timeslots for the full 4,096 ports, you must enable both the C-bus mode and Extended Operational mode.

Enabling C-bus mode, in addition to the Extended Operational Mode, allows the switch to use C-bus timeslots, and is required to use the full 4,096 ports. Three screens have been modified to accommodate the C-bus enable option:

- Installation Utilities
- Administrator Main Menu
- System Features

Installation Utilities Menu

C-bus operational mode requires an addition to the Installation Utilities menu as shown in *Figure 2.3*. Select **8** for the new Enable C-Bus Mode option.

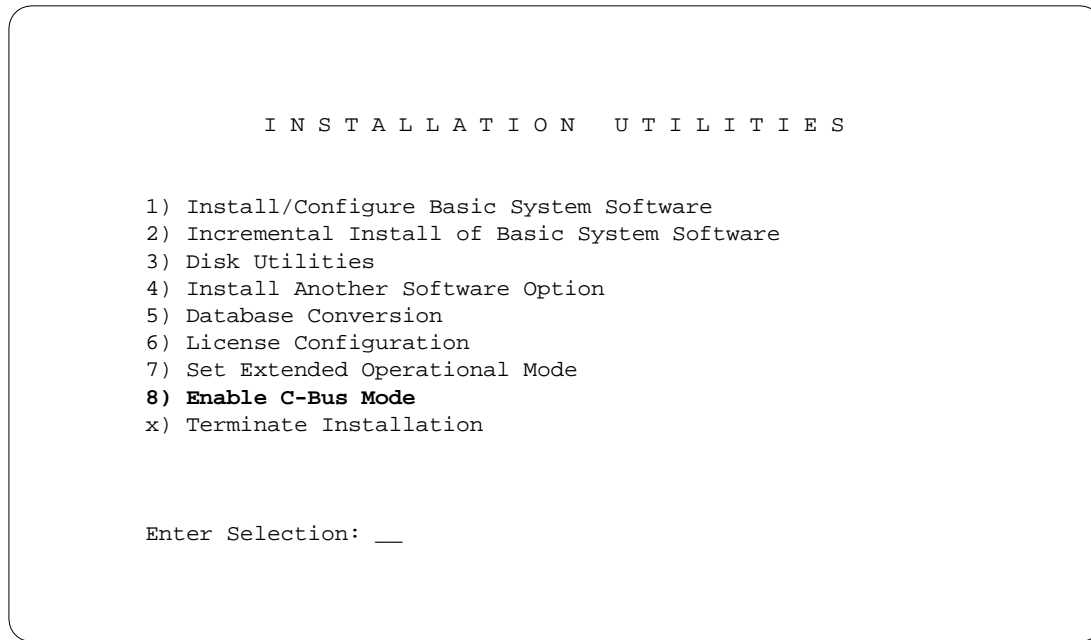

TP000006

Figure 2.3: Installation Utilities Screen

When selected, an Enable C-Bus Mode. Are you sure (Y/N) =N? prompt displays on the screen. If unsure, press **ENTER**. Otherwise, press **Y** then **ENTER** to continue.

If the C-bus mode is enabled but no C-bus is installed, an Error: C-Bus is enabled but it is not installed message is displayed. If the C-bus mode is not enabled and no C-Bus is installed, an Error: C-Bus is not installed message displays.

Administrator Main Menu Screen

The Administrator Main Menu screen, shown in *Figure 2.4*, displays a message if C-bus is enabled. If C-bus is installed and the hardware is detected, a C-Bus Enabled message appears on the lower right corner of the screen. However, in the unusual event that the hardware is not detected, a C-Bus ERROR message displays.

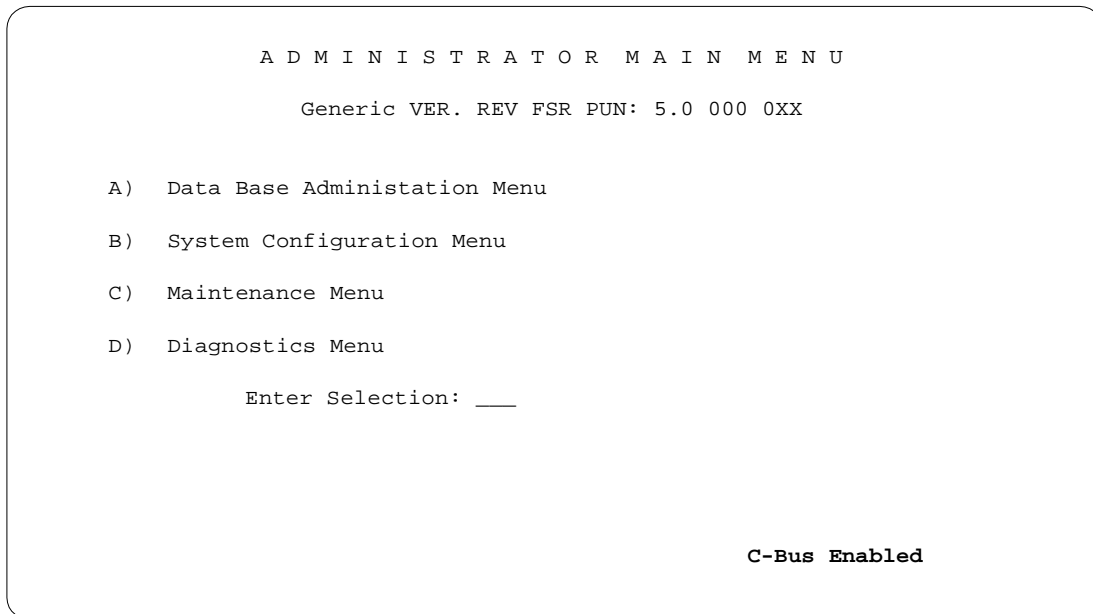

TP000003

Figure 2.4: Administrator Main Menu Screen

System Features Screen

A C-Bus Mode Enabled flag is added to the System Features screen, as shown in *Figure 2.5*. This flag is read-only. If the flag is set to Y, C-bus is enabled, and your switch can take advantage of the 4,000 ports (if C-bus is installed). If the flag is set to N, C-bus is disabled, and your system is limited to approximately 2,000 ports.

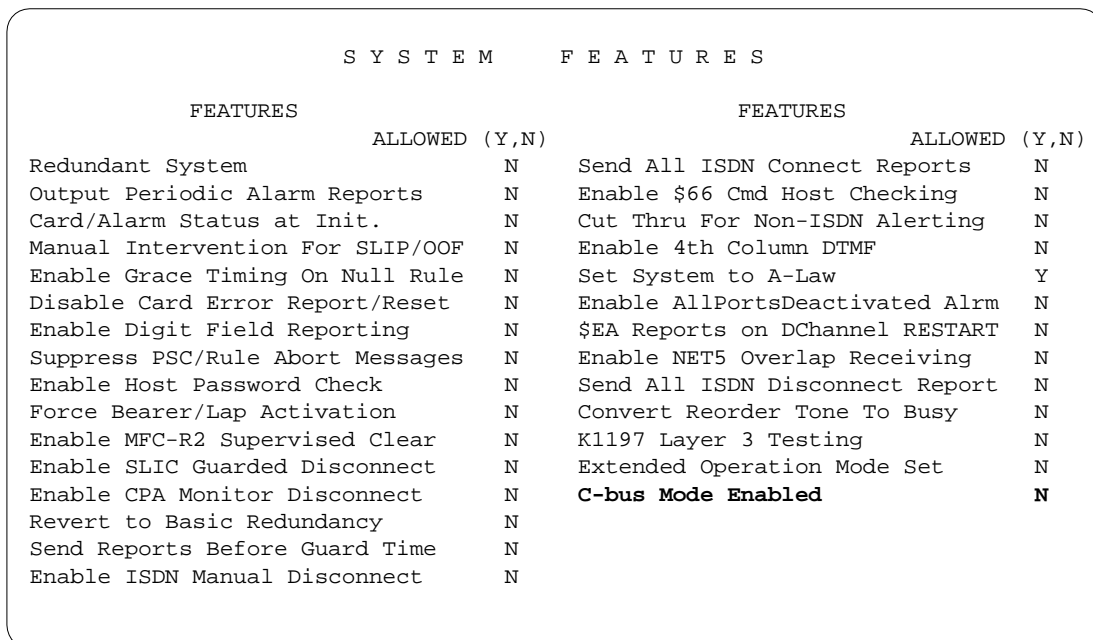

TP000089

Figure 2.5: C-bus Mode Verification Flag

2.5.2 VCO 4K Series Label

New VCO/4K systems display a VCO 4K Series label on the front of the VCO chassis and an IV K label on the front panel of each individual card. If upgrading your existing VCO switch to a VCO/4K switch, the 4K labels are included in your upgrade package.

2.5.3 Card Type Attributes

Currently, the MVDC T1 and IPRC, and the new Interface Controller Card and Service Platform Card, are supported for 4K mode (can use the C-bus timeslots) when running Generic V5.1 software. Refer to *Section 2.6* and *Section 2.7* for more information about the Interface Controller Card and Service Platform Card.

2.6 INTERFACE CONTROLLER CARD

The Interface Controller Card (ICC) is a Type 2 programmable interface card that supports up to 16 spans. The ICC supports T1/E1 voice communications capabilities for the VCO switch. The ICC is not a stand-alone interface: a multi-span T1/E1 I/O module must be physically connected to the ICC from the rear of the switch. The I/O module controls the transmission of signaling to and from the switch. Refer to the *Interface Controller Card (ICC)* and *Interface Controller Card I/O Module* technical descriptions for more information.

2.6.1 ICC Programmable Trunk Configuration Screen

With the ICC, you can assign the signaling protocol for each port. This is done from the new ICC Programmable Trunk Configuration screen, as displayed in *Figure 2.6*.

```

I C C P R O G R A M M A B L E T R U N K C O N F I G U R A T I O N

SPAN LOCATION: R,L,S 1 1 4-1-1      STATUS: Out of Service
CARD TYPE: ICC-T1                  SPAN TYPE: SF          CODE: AMI
TXGAIN: 0db      TXCLK: SCLK        SLIP: 255             LENG: 0-133
RXGAIN: 0db      RFCLK: LOOP        OOF: 17

PORT      TRUNK      GROUP      GROUP      SIG.      INPULSE      COS      LAW
-----  -
1         T1          4          T1S       E&M       0            2
2         T2          4          T1S       CLEAR     0            2
3         T3          4          T1S       CLEAR     0            2
4         T4          4          T1S       CLEAR     0            2
5         T5          4          T1S       CLEAR     0            2
6         T6          4          T1S       E&M       0            2
7         T7          4          T1S       E&M       0            2
8         T8          4          T1S       E&M       0            2
    
```

TP000081

Figure 2.6: ICC Programmable Trunk Configuration Screen

The functionality of the ICC is similar to the 4xT1 or MVDC T1 programmable interface cards, with the exception of additional spans. Refer to the *System Administrator's Guide, Programmable Trunk Card Configuration Screen* for field values and defaults.

The visible difference between the Programmable Trunk Configuration screen and ICC Programmable Trunk Configuration screen is that, in the ICC screen, the TIMING field has been replaced by the LAW field. The LAW field indicates the voice coding of the port rather than the span as in other programmable trunk cards.

Valid values for the LAW field are A for A-law, Mu for Mu-law, and SYS for system backplane law. When the port is set to SYS, the port law is configured to match the entry in the Set System to A-Law field in the System Features screen. This is useful for ports carrying signaling data which cannot undergo law conversion.

2.6.2 Valid Signaling Protocols

The ICC T1 signaling protocols supported with Generic V5.1 software include:

- D4 E&M
- D4 Clear Channel
- ESF (robbed-bit signaling)
- ESF Clear Channel

The ICC E1 signaling protocols supported with Generic V5.1 software include:

- CAS/R2
- CCS/31

NOTE: There are six additional protocols that may appear as a selection: USER1 to USER6. Although visible on the screen, these protocols cannot be implemented; they are to be used in a future enhancement.

2.6.3 ICC and SNMP

SNMP support for the ICC is provided with Generic V5.0 or greater. Two new tables have been added: iccTable for interface configuration, and iccPortTable for port configuration.

2.6.4 ICC E1 and ISDN NET5

ISDN NET5 support for the ICC E1 is provided with Generic V5.1. A single download supports all 16 ICC ISDN spans (with a 16xE1 I/O module). Each span can operate either with 28 B-channels (bearer) and a D-channel, or with 29 B-channels. Spans that are designated as B-channels only are not restricted to B-channel operation; the spans can be used for SS7, transmission only (no signaling), or any combination of operation.

ICC E1-ISDN NET5 supports the same functionality currently supported by both versions of the ISDN single-span cards.

The number of spans terminated (visible on System Administration screens) is determined by the I/O module used in conjunction with the ICC. (Refer to the *Interface Controller Card I/O Module* technical description for details regarding span configuration.) The new ICC ISDN NET5 card type appears in the System Administrator's Card Summary and Card Maintenance screens as ICC-E1 PRI/NET5.

Software Download

Currently, the ICC ISDN NET5 software is directly programmed to the ICC FLASH. In a future release, the software will be downloaded from the generic software. However, the protocol data, for CLEAR CHANNEL, is currently downloaded from the generic software.

System Administration Changes

Two of the fields on the PRI Card Configuration screen, shown in *Figure 2.7*, have been modified: Switch Type and Span Type. The Switch Type field now allows only NET5 switch types as a selectable option. The Span Type field remains the same if a T1 span type is recognized by the system. If an E1 span type is recognized by the system, the Span Type field name changes to CRC4. The selectable options for an E1 span in the CRC4 field is ON or OFF.

```

      P R I C A R D C O N F I G U R A T I O N

CARD LOCATION: R,L,S 1 1 4-1-1          TYPE:  ICC-T1 PRI/NET5
                                         STATUS: Active

DISPLAY PROTOCOL PARAMETERS ___
ACCESS TYPE: USER      TRX CLOCK: SCLK  CA IP RULE: 2  SLIP MAINT LIMIT: 255
SWITCH TYPE: AT&T 5E  REF CLOCK: RCVD  NCA IP RULE: 0  OOF MAINT LIMIT: 17
SPAN LENGTH: 0-133    SPAN TYPE: ESF   A/Mu LAW:  Mu

```

PORT	NAME	GROUP	GRP NAME	COS
1		3	icc2	2
2		3	icc2	2
3		3	icc2	2
4		3	icc2	2
5		3	icc2	2
6		3	icc2	2
7		3	icc2	2
8		3	icc2	2

TP000181

Figure 2.7: PRI Card Configuration Screen

There are no new on-screen or error messages; the current ISDN messages that appear on the master console apply.

\$A8/04 Command

A new ISDN span configuration command, \$A8/04, has been added. This message configures ISDN stack specific span parameters for one or more spans on the ICC. If multiple spans are configured identically, the spans are identified in the Interface Byte, see *Figure 2.8*. This message is derived from the \$13 command, and follows the \$A8/01 command for configuring an ISDN span.

The \$A8/04 message is applicable only to the ISDN ICC. See *Figure 2.8* for the \$A8/04 message format.

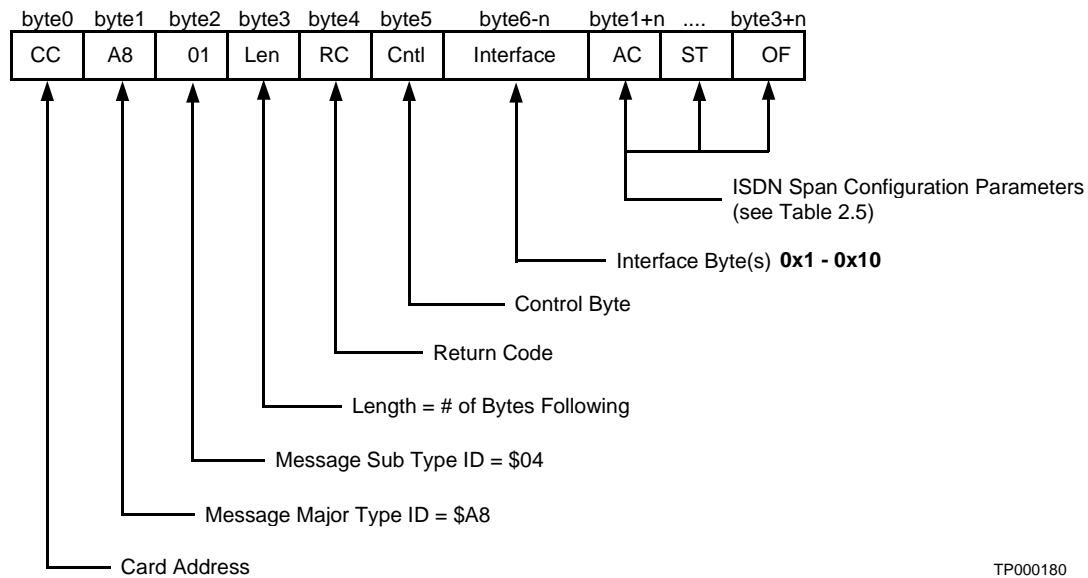

Figure 2.8: \$A8/04 Message Format

Table 2.5 displays the ISDN span configuration parameters for byte1+n, ..., and byte3+n of the \$A8/04 command, as shown in *Figure 2.8*.

Table 2.5 \$A8/04 ISDN Span Configuration Parameters

AC (Access Control)	ST (Switch Type)	OF (Overlap Feature)
\$10 - USER side	\$01 - AT&T 5ESS	\$00 - Overlap feature not enabled
\$20 - NETWORK side	\$02 - NT DMS100	\$01 - Overlap feature enabled
\$30 - USER side SYMMETRICAL	\$03 - AT&T 4ESS	
\$11 - USER side, NFAS	\$10 - NI2	
\$31 - USER side SYMMETRICAL, NFAS	\$40 - NET5 Austria	
\$21 - NETWORK side, NFAS	\$41 - NET5 Belgium	
\$80 - NFAS	\$42 - NET5 Denmark	
	\$43 - NET5 Finland	
	\$44 - NET5 France	
	\$45 - NET5 Germany	
	\$46 - NET5 Greece	
	\$47 - NET5 Iceland	
	\$48 - NET5 Ireland	
	\$49 - NET5 Netherland	
	\$4A - NET5 Norway	
	\$4B - NET5 Portugal	
	\$4C - NET5 Spain	
	\$4D - NET5 Sweden	
	\$4E - NET5 Switzerland	
	\$4F - NET5 UK	
	\$50 - NET5 Luxemburg	
	\$51 - NET5 Italy	
	\$80 - DASS2 Exchange Termination	
	\$81 - DASS2 Network Termination	
	\$82 - Japanese NTT	
	\$88 - DSS1 Termination	
	\$8C - DPNSS A, X	
	\$8D - DPNSS A, Y	
	\$8E - DPNSS B, X	
	\$8F - DPNSS B, Y	

ICC E1 ISDN NET5 Restrictions

When running Generic V5.1 software, you may find certain restrictions in ICC ISDN NET5 functionality. Those restrictions are listed below.

- ICC ISDN NET5 currently supports 29 channels. Channels 30 and 31 cannot be used at this time. This will be addressed in the next software release.
- A usable voice path is completed only if you configure the span for Mu-law on the Pri Card Configuration screen. If you set the A/Mu Law field to A-law, a voice path cannot be established. (From the System Features screen, you can configure the backplane for either A-law or Mu-law.) This will be addressed in the next software release.
- If both sides of your system are configured as Network side, the card should not become active. It may, however, become active because the ICC sends a D-channel message that may appear to the other side as if it is the User side.

SNMP and ICC ISDN NET5

Implementation of SNMP support for ICC ISDN NET5 is planned for a future release.

2.7 SERVICE PLATFORM CARD

The Service Platform Card (SPC) is a Type 2 control circuit card that combines the capabilities of service circuit cards into a single card. The SPC contains all of the functions provided previously by each individual card.

The SPC supports download of configuration data from the system controller. Therefore, you can modify operating parameters without requiring a new application download. You can easily generate country support packages for SPC service types by modifying the SPC download data files.

The SPC currently supports the following functions:

- DTMF Receiver
- DCC - Conferencing
- MFCR2
- CPA (Call Progress Analysis)
- Outpulsing
- MFR1 - Receiver

2.7.1 SPC DTMF Reception

SPC-DTMF provides 32 channels of DTMF detection on each DSP.

2.7.2 SPC Conferencing

The SPC conferencing feature currently supports the functionalities that exist with the Digital Conference Card (DCC) generic software. Refer to the *Digital Conference Card* technical description for more information.

Only one type of conference card may be configured in the resource group at a time, i.e., DCC or SPC-CONF. Up to 255 concurrent conferences, and a maximum of 8 legs per conference, are supported.

The SPC-CONF supports 32 channels of conferencing on each DSP.

Refer to the *Service Platform Card* technical description for more information.

2.7.3 SPC-MFCR2

The SPC-MFR2 can provide 24 channels of MFCR2 on a single DSP.

2.7.4 SPC-CPA

The SPC-CPA can provide 32 channels of CPA on a single DSP.

2.7.5 SPC Outpulsing

The SPC Outpulsing capability allows you to create a resource group for outpulse channels. Since multiple SPC service engines may be configured for outpulsing, you can provision as many outpulse channels to the application as you need. By contrast, outpulsing on the DTG card imposes a 63-channel system limit.

The SPC Outpulsing card uses 64 consecutive timeslots to provide 63 outpulse channels, and appears in the System Administrator's Card Summary screen as SPC-OUTP. You can add or delete this new card type into or from the database at the span level. The SPC-OUTP ports are ready to be used as outpulse channels if the span is active, and if the ports are in a resource group.

SPC Outpulsing requires a DTG or DTG2 card to handle the steady state tones such as quiet, busy, etc. When a DTG and an SPC-OUTP card are installed in the same switch, none of the DTG ports can be used as outpulse channels if there is a resource group with SPC-OUTP ports, even though there are no ports available in that resource group. If the system does not detect a resource group with SPC-OUTP ports, the DTG ports will be used for outpulsing. A status message is generated if no SPC-OUTP ports are available from the resource group, or if a resource group with SPC-OUTP ports is not detected and no DTG ports are available. The status message is FRM065: DTMF/MF SENDERS EXHAUSTED.

When the system searches for an outpulsing channel, the hunt of the port always starts from the SPC-OUTP resource group, if established, otherwise a DTG port hunt is conducted.

2.7.6 SPC-MFR1

The SPC-MFR1 provides 32 channels of multi-frequency R1 (release 1) detection on each DSP. As with other SPC services, the SPC-MFR1 resources cannot be used in a resource group with the pre-existing card, in this case, the MF Receiver Card (MRC).

2.8 TIMESLOT ALLOCATION LICENSING INCREASE

New systems are now shipped with generic software V5.0 FSR00 or greater and 880 pre-allocated timeslots, which support up to 880 individual ports. Once your system configuration reaches 880 ports, you cannot add more cards to the system until you upgrade your timeslot license. Timeslot licenses are now sold in 536 slot increments, up to a maximum of 4,096 timeslots for 4K port systems and 1,808 for 2K port systems.

Previously, new systems were shipped with 696 pre-allocated timeslots, and timeslots were sold in 360 slot increments, up to 1,776.

*NOTE: You can now exit the License Configuration screen, which appears during the installation process, by pressing the **Enter** key without entering any numbers.*

2.8.1 License Configuration Screen Modification

The License Configuration screen has changed to better reflect the timeslot information that is displayed at the bottom of the main menu and Card Maintenance screens. See *Figure 2.9* for a sample of the new screen.

The number of timeslots licensed refers to the actual number of purchased timeslots. The number of timeslots available may be more or less than the number of timeslots licensed for the following reasons:

- A 2K system may have more than 2,000 timeslots licensed. The maximum number of timeslots available in a 2K system is 1,936.
- The Digital Tone Generator (DTG) card timeslots are “free.” The number of timeslots available is adjusted upward to reflect the free DTG timeslots.

LICENSE CONFIGURATION		
	A - Side	B - Side
Number of Time-Slots Allocated	128	128
Number of Time-Slots Available	1008	1008
Number of Time-Slots Licensed	880	880
Serial Number	08003e23e953	08003e24223b
License Number	c6c9c9d9511b	8e14ce61741c
Enter License #:	_____	_____

TP000060

Figure 2.9: License Configuration Screen

Refer to *Section 4* of the *System Administrator's Guide*, for detailed information regarding timeslot allocation licensing.

2.9 REDUNDANCY ENHANCEMENTS

Enhancements have been added to various redundancy functions in order to decrease the processing/initialization time.

2.9.1 Modify Initialization of Subracks

In previous releases, during system initialization, delays existed between the initialization of subracks. This delay occurred regardless of the card population of the subrack. The system has been enhanced to initialize each subrack based on population requirements. In a V5.0 and later system, this enhancement decreases the system initialization time by 30 seconds.

2.9.2 Eliminate Redundancy Messages for Empty Conferences

In previous software releases, empty conference structures were passed over the update channel to the standby controller. This method presented update queue overflow issues. System redundancy has been modified so that these structures are no longer sent to the standby controller.

2.9.3 Flow Control for Update Channel

Flow control has been improved on the update channel protocol for file synchronization. This enhancement eliminates queue overflows and unnecessary delays. File synchronization on a redundant system now completes in less than one minute.

2.10 SYSTEM ADMINISTRATION ENHANCEMENTS

To accommodate the 4K port configuration, various enhancements have been made within the system administration functions. These enhancements appear on the master console screen.

2.10.1 Add/Delete Type 2 Cards by Span

You can now add or delete the MVDC T1 card by span (interface). The ICC can be added by group and relative span. The Group and Span (relative interface) fields apply to Type 2 cards.

In software versions prior to Generic V5.0, you entered the Rack, Level, and Slot fields. You can now enter the Rack, Level, and Slot/Group/Span, if applicable.

NOTE: Only "add by card" is supported for the MVDC T1 via SNMP.

2.10.2 Start Number Field

With the increase in system limits, the ability to quickly locate a particular inpulse/outpulse rule or resource group is important. In previous versions of the software, you paged through the list. In V5.0 and later, you may also type the number of the inpulse/outpulse rule or resource group at the new field in the upper right corner of the screen.

Figure 2.10 displays the new field in the Inpulse Rules screen. A similar field is also included in the Outpulse Rules Table and Resource Group Summary screens.

C A R D S U M M A R Y						
LOCATION			CARD TYPE	STATUS	UNUSED	DISP
R	L	S			PORTS	CARD
1	1	1-1	Network Bus	A	0	-
1	1	1-2	Tone Generator	A	1	-
1	1	3-2-1	ICC-T1	O	0	-
1	1	3-4-1	ICC-T1	O	0	-
-	-	---	-----	-	---	-
-	-	---	-----	-	---	-
-	-	---	-----	-	---	-
-	-	---	-----	-	---	-
-	-	---	-----	-	---	-
-	-	---	-----	-	---	-
-	-	---	-----	-	---	-
-	-	---	-----	-	---	-
-	-	---	-----	-	---	-
-	-	---	-----	-	---	-
-	-	---	-----	-	---	-

TP000023

Figure 2.11: Slot/Group/Span Field Display

The system administration screens affected by the **S** field change include:

- Card Summary (Go to Database Administration/Card Summary)
- Resource Group Configuration (Go to Database Administration/Resource Group Summary/ Resource Group Configuration)
- Card Maintenance (Go to Maintenance/Card Maintenance)
- Card Alarm Display (Go to Maintenance/Card Alarm Display)
- Set Up Paths (Go to Diagnostics/Set Up Path)
- Card Display (Go to Diagnostics/Display Card Data)
- Port Display (Go to Diagnostics/Display Port Data)
- Service Circuit Test Utility (Go to Diagnostics/Test Service Circuits)
- Test Port Card (Go to Diagnostics/Test Port Card)
- Call Progress Tone Monitor (Go to Diagnostics/Monitor Call Progress Tones)
- Generic Packet Utility (Go to Diagnostics/Send Packet Utility)
- Conference Display (Go to Diagnostics/Display Conference Data)
- Master Timing Link Selection (Go to Maintenance/Master Timing Link Selection)

2.10.4 Propagate Port Parameters

The Programmable Trunk Configuration screens (for 4XT1, 4XE1, MVDC T1, ICC T1, and ICC E1) support propagation of port parameters across an entire span. When you select or modify the SIG. TYPE, INPULSE RULE, COS (class of service), or LAW fields on port 1 for a given span, a prompt appears on the screen: Enter Y to propagate port 1 values. Press Y and all remaining ports are configured with the same parameter entered for port 1. This feature reduces duplicate data entry.

NOTE: Propagate parameter data does not appear for other ports until a screen refresh is performed.

NOTE: With Generic V5.0 and later, when adding any programmable trunk card, the default for the COS field is 2.

2.10.5 Change Card Status For Multi-span Cards

You can now change the status of all spans of a card with a single command from the Card Maintenance option. With this new feature, you no longer need to specify a particular span, although that option is still available.

In software versions prior to V5.0, to activate a card you had to type each span individually, for example, 1 1 4-1, 1 1 4-2, 1 1 4-3, etc. With V5.0 and above, you type 1 1 4, and all spans in the 4 group become active.

2.11 MISCELLANEOUS SOFTWARE ENHANCEMENTS

2.11.1 Turbo NBC Download

The NBC download process has been improved. The present NBC download takes approximately one-third of the time of the previous NBC download process. Since NBC download occurs during every system reboot, this will result in improved system availability.

2.11.2 MFCR2 Enhancement for Outpulsing Different Categories

In order to outpulse a category digit, you need to define an outpulse rule with the OP CAT [xx] token. The OP CAT token takes a single digit field as a parameter where the category digit can be specified. If you want to outpulse "n" different category digits at different times, "n" different outpulse rules are required, where each rule would specify a different digit. Since there are a limited number of outpulse rules, this could be a resource limitation.

Two new tokens have been added to address this issue: OP CAT2 and IP CAT2. Refer to *Section 3 of the System Administrator's Guide* for detailed information.

2.11.3 ASIST

As part of the V5.0 release an updated version of ASIST is provided. This release supports both versions of the Host API. It also provides a new command which allows the application to switch between standard (2K) and extended (4K) mode.

The data structures within previous releases of ASIST have been expanded to accommodate the Extended Host API. This includes additional fields and larger field sizes. ASIST provides both versions of the structures in order to remain backward compatible. For the sake of description, the smaller structures (V4.0 and earlier) are referred to as V4.0 structures and the updated expanded structures (V5.0 and later) are referred to as V5.0 structures.

To use the Extended API, you must use V5.0 structures. You can use either structure set with the Standard API. In cases where the V5.0 structures are used with the Standard API, unused fields, such as tone plan, are ignored, and the larger field sizes are masked in the message being built. Initialize any unused fields to 0.

Instead of providing two physically separate sets of files to handle the two structure sets, the files are combined. Conditional compiling specifies which structure set to use. Set constants to **STANDARD** to specify the V4.0 structures and **EXTENDED** to specify the V5.0 structures. These constants are set up on a per message basis. This allows you to migrate from the V4.0 structures to the V5.0 structures one message at a time. The constants may also be set as a group by setting **DEFAULT_API_MODE** to the desired mode.

NOTE: Refer to the Standard and Extended ASIST/API Programming Reference for detailed information and installation instructions.

2.11.4 SNMP

Changes made to SNMP include the addition of the read-only Extended Operation Mode Set feature flag (shown in *Figure 2.2*). Type 1 cards (for 2K port systems) cannot be added to a C-bus enabled switch.

NOTE: MIB files are not backward compatible: the current SNMP agent is not compatible with earlier versions of MIB files. You must download and use the MIB file shipped with the V5.1 release.

Figure 2.12 displays the section added to the MIB.

```
featureOperationModeExtended OBJECT-TYPE
    SYNTAX INTEGER {
        no (1),
        yes (2)
    }
    ACCESS read-only
    STATUS mandatory
    DESCRIPTION
        " If this feature is set to no, the current operational
          mode is standard mode. If set to yes, the operational
          mode is extended mode."
    ::= { features 22 }
```

TP000021

Figure 2.12: MIB Changes

2.12 MASTER CONSOLE MESSAGES

Prompts, warnings, and error messages that appear on the lower right corner of the system administration screen have been revised as needed to accommodate the changes made to the system administration functions. These on-screen messages are listed below. (Refer to *Appendix A of the System Administrator's Guide* for a complete list of system administration messages.)

2.12.1 New Error Messages

The following error messages may appear in various system administration screens that utilize the Rack-Level-Slot/Group/Span feature.

- ERROR: Interface Not In Database
- ERROR: Interface Already Exists
- ERROR: Interface Is Not Out Of Service
- ERROR: Interface Does Not Have Ports

2.12.2 Error Messages Previously Restricted to Card Maintenance Screen

The following error messages previously appeared only in the Card Maintenance screen. These messages are now general support error messages and may appear in various system administration screens in which the Rack-Level-Slot/Group/Span field is displayed.

- ERROR: Card Already Exists
- ERROR: Card Does Not Have Ports
- ERROR: Card Is Not Out Of Service
- ERROR: NBC in 1 1 1 Cannot Be Deleted
- ERROR: Perform Operation On Card
- ERROR: Ports Still In Resource Group X

2.12.3 Messages Added to Card Maintenance Screen

The following messages may appear when you are working in the Card Maintenance option. These message are added to support the new cards and the “add/delete card by span” feature.

- Interface Is Deleted
- This Type Is Not Compatible To The Slot

2.12.4 Messages Deleted From Card Maintenance Screen

The following message have been deleted from the Card Maintenance option.

- Card Must Be Taken OOS Before Active
- Operation Supported by Subrate Card Only

2.13 4K PORT RESTRICTIONS

When running a 4K port system with Generic V5.1 software, you may find certain restrictions in system functionality. Those restrictions are listed below.

2.13.1 IPRC Record Function Disabled

The IPRC is allowed in a C-bus enabled switch; however, the IPRC record function is disabled. When running Generic V5.1, if you attempt to execute the MAXRECORD or RECORD token in a C-bus switch, the following error messages are displayed:

- MAXRECORD feature has been disabled due to C-bus
- RECORD feature has been disabled due to C-bus

A network status byte of 62 indicates that a record operation was attempted for the IPRC in a C-bus switch

- Network Status Byte: 62 RECORD_DISABLE

Section 3

SYSTEM REQUIREMENTS

This section provides a listing of system requirements for running Generic V5.1 FSR00 software. These requirements are divided into hardware, firmware, and software. Contact Summa Four, Inc. Technical Support at 1-800-9SUMMA4 or +603-695-1293 for any site-specific information.

3.1 HARDWARE REQUIREMENTS

To operate Generic V5.1, a system must be equipped with the following minimum components:

System Controller

- VME-147 System Controller Card (must have updated boot PROMs) or Combined Controller (16 MB 68030-based CPU).
- CPU Transition Module (CPU-TM) or Storage/Control I/O Module
- SWI Version A0AR

Storage Subsystem

- SCSI interface hard drive, 42 Megabytes or larger
- 3.5" SCSI Interface Floppy Drive

Control Circuit Cards

- NBC-3 card Rev C0GR (or later) or E0AR (or later)
(Two NBC-3 cards are required for redundant systems; one NBC-3 for non-redundant systems.)

NOTE: For detailed information regarding NBC-3 card hardware requirement, see the Technical Description: Network Bus Controller-3 (NBC-3) Card.

- Alarm Arbiter Card Rev COUR (or later) is required for C-bus operation

Service Circuit Cards

- DTG-2 or DTG—Digital Tone Generator
(All systems require a tone card to provide a quiet tone to the network.)

If you are planning to use SNMP on your system, an SNMP network management application or platform is recommended. You will need an SNMP application to perform SNMP tests on your system. One alternative is to use the tools available with applications such as Hewlett Packard's OpenView™ or Sun Microsystem's Net Manager®.

3.2 FIRMWARE REQUIREMENTS

System firmware requirements common to all systems are listed in *Table 3.1*. *Table 3.2* lists North American firmware requirements. Refer to the technical descriptions in Volumes 3 and 4 of your hardware documentation set for firmware locations for each card.

For country specific firmware requirements (which affect DTG-2 or DTG, CPA, and MFCR2 cards) refer to the applicable country supplement.

NOTE: The firmware label applied by Summa Four may list only the last four digits of the checksum.

The checksum for the NBC-3 LP125 is not listed because the programming for this item is part of the NBC-3 download file and is included in the checksum for the NBC download file.

Table 3.1 Common Firmware Requirements

Card	Firmware	Checksum	Version	Location	Changed Since V5.0 FSR00 PUN25
North American Requirements					
BRC	BRC	00002412	2.01	U2	N
CPA	CPA	0000A7A2	1.03	U2	N
CPU	Boot EVEN	006E691D	5.00	U1	N
	Boot ODD	00866CBF	5.00	U15	N
	MVME147-023 ODD	5741B41F	2.44	U30	N
	MVME147-023 EVEN	5741B42F	2.44	U22	N
D+I	D+I	00A998F6	2.01	U9	N
DID-2	DID-2	000010C3	1.41	U2	N
DRC-8	DRC	00009625	5.23	U2	N
DRC-24/48	DRC-2	00004241	3.08	U2	N
DVC	DVC	000095BE	2.07	U2	N
E+M	E+M	0000D381	2.06	U2	N
E1-CAS	E1-CAS/MERC	0000F1C6	2.13	U23	N
	E1-CAS/R2	00002654	2.01	U23	N
	E1-31B	0000EF58	3.03	U23	N
	E1-CAS/R2 (No CRC4)	000EDF08	3.43	U23	N
	CAS PROC	00001E78	1.04	U85	N
	32 CHAN SETUP	0000CDDE	1.00	U113	N
	GAIN/LAW PROM	000011D2	1.02	U45/53	N
ICC	ICC	—	—	—	N

Table 3.1 Common Firmware Requirements (Continued)

Card	Firmware	Checksum	Version	Location	Changed Since V5.0 FSR00 PUN25
IPRC-8	IPRC 8-PORT	00220D75	1.03	U2	N
IPRC-64	IPRC 64-PORT	00220DC1	1.03	U2	N
IPRC-128	IPRC 128-PORT	00220E0A	1.03	U2	N
MRC	MRC	0000EE80	3.08	U2	N
MVDC-T1	Local Bus	000D373B	LP100A	U35	N
	Com Bus	00186169	LP101A	U19	
	Interrupt	000AE787	LP102	U75	
	PCM Interface	001748E3	LP103A	U107	
	Framer	0005FE2C	LP104	U76	
	Gain/Law	0005A153	LP105B	U49	
	T1 Clock	000BE051	LP106	U80	
	Gain/Law	00776220	—	U50	
	Boot PROM	0066DF90	1.08	U10	
NBC-3 Card Rev C	LP122 SWI	00194974	LP122C	U66	N
	LP123 Counter	0018E096	LP123E	U13	
	LP124 Chip Select	000D7B43	LP124C	U12	
	LP125 Com Bus FPGA	—	LP125C	U43	
	LP126 Com Bus EPLD	0005CED8	LP126B	U47	
	LP127 Mezzanine Add.	0006C919	LP127A	U105	
	Boot PROM	00F597BE	1.02	U4	N
NBC-3 Card Rev E	LP141 SWI	0019204D	LP141A	U31	N
	LP140 Counter	00172D75	LP140D	U73	
	LP139 Chip Select	000D4209	LP139A	U30	
	LP125 Com Bus FPGA	—	LP125C	U53	N
	Boot PROM	00F597BE	1.02	U1	N
SLIC-2	SLIC-2	000010B9	1.41	U2	N

Table 3.1 Common Firmware Requirements (Continued)

Card	Firmware	Checksum	Version	Location	Changed Since V5.0 FSR00 PUN25
SSC	Com Bus Control	00186169	LP101A	U24	N
	PCM Interface	00185A34	LP130B	U76	N
	Quad 9 to 1	0017878C	LP129A	U71/U70	N
	Redundancy Control	0017F249	LP128A	U100	N
	Subrate Matrix Control	000BB573	LP131	U31	N
	Boot PROM	00400736	1.02	U10	N
T1	T1	00002BA5	1.26	U2	N
	T1 Aux Proc	00007125	1.00	U45	N
UTC-2 Rev A UTC-2 Rev B	UTC	0000F91E	6.00	U2	N
	UTC	0000ECF0	6.54	U2	N
4XT1/E1	4XT1 68340 VIRT CM	28FAF0	1.09	U10	N
	4XT1 68302 ODD	00277AE4	1.14	U47, 93, 150, 185	N
	4XT1 68302 EVEN	00242750	1.14	U48, 94, 151, 186	N
	GAIN/LAW CCITT G.711	000FCD68	1.03	U25, 28, 67, 78, 120, 131, 158, 170	N
	PATH SETUP ROM	0000CDDE	1.00	U35, 86, 116,178	N
International Requirements					
E1-PRI (NTDASS2, DPNSS)	E1-PRI FW Odd	00105999	1.03	U38	N
	E1-PRI FW Even	000DA6C3	1.03	U39	N
	E1-PRI 32 Chan Setup	0000CDDE	1.00	U113	N
	PCM Gain/Law	000011D2	1.02	U45/53	N
E1-PRI 120Ω (NET5)	Net5 ODD	1075A4	1.04	U38	N
	Net5 EVEN	DB375	1.04	U39	N
PRI	PRI FW Odd	00107EA5	1.02	U38	N
	PRI FW Even	000DB30B	1.02	U39	N
	32 Chan Setup	0000CDDE	1.00	U29	N
	PCM GAIN/LAW	000011D2	1.02	U45/53	N

Table 3.1 Common Firmware Requirements (Continued)

Card	Firmware	Checksum	Version	Location	Changed Since V5.0 FSR00 PUN25
International Requirements (Continued)					
PRI/N	ODD	00115CB1	1.09	U38	N
	EVEN	000DEE1D	1.09	U39	N
	32 Chan Setup	0000CDDE	1.00	U29	N
	PCM Gain/Law	000011D2	1.02	U45/53	N
4XE1	4XE1 68340 VIRT CM	28FAF0	1.09	U10	N
	4XE1 68302 ODD	00263E25	1.04	U47, 93, 150, 185	N
	4XE1 68302 EVEN	002313DD	1.04	U48, 94, 151, 186	N
	GAIN/LAW CCITT G.711	000FCD68	1.03	U25, 28, 67, 78, 120, 131, 158, 170	N
	PATH SETUP ROM	0000CDDE	1.00	U35, 86, 116,178	N

Table 3.2 North American Firmware Requirements

Card	Firmware	Checksum	Version	Location	Changed Since V5.0 FSR00 PUN25
DCC	DCC	0000A575	2.02	U2	N
	LIN/PCM 0 DB	0000B9A2	1,00	U43	N
	LIN/PCM -3 DB	0000AB04	1.00	U44	N
	PCM/LIN Odd	0000AFA2	1.00	U33	N
	PCM/LIN Even	0000B736	1.00	U34	N
DTG/DTG-2 (North American Tone Plan)	DTG-FW ^a	00007991	1.24	U2	N
		00007C30	1.25	U2	
	Tone ODD	00000078	2.04	U54	
	Tone EVEN	00004217	2.04	U53	

a. Version 1.24 or 1.25 is required. Version 1.25 supplies an additional tone for North American customers. For firmware supporting other countries, see the Master Configurator Release Notes (63098350133).

3.3 SOFTWARE REQUIREMENTS

Valid software checksums and versions for the Generic V5.1 FSR00 software and optional software products are listed in *Table 3.3*.

Use the Software/Firmware Configuration utility to identify the version and checksum of each software file installed on the system (refer to the *System Administrator's Guide* for more information). Generic software files are distributed across the installation floppy diskettes. Each optional software product is contained on a single floppy diskette.

Table 3.3 V5.1 Software Requirements

Software Product	Software Version	Filename	Checksum	File Version	Changed since V5.0 FSR00 PUN25
Executable Files	5.1.50	GLOBALS.EXE	0154AEA1		Y
		HOSTMGR.EXE	0387D100		Y
		SYSWD.EXE	0220F72B		Y
		REDMGR.EXE	00F52920		Y
		PERMGR.EXE	013A8FB7		Y
		NETMGR.EXE	02E53D9C		Y
		SNMP.EXE	019E3770		Y
		INSTALL.EXE	0226FC03		N
Download Files		MVDCT1.DWN	00F2D33A	1.08	N
		NBC.DWN	01095DE7	1.08	N
		SSC.DWN	006C84CB	1.00	N
		CPA.DWN	003079F3	8.09	N
		DVC.DWN	005ADA02	1.08	N
		DTMF.DWN	00053D1A	2.02	N
		IPRC.DWN	0022E1EA	1.04	N
		4xT1.DWN	00349052	1.49	N
		4xE1.DWN	003773FA	1.39	N
		SPC.DWN	0603A64D	4.09	Y
		ICC.DWN	0612C55A	4.95	Y
		ICCCASR2.UPG	0000071D	—	N
		ICCCCS31.UPG	00000128	—	N

Table 3.3 V5.1 Software Requirements (Continued)

Software Product	Software Version	Filename	Checksum	File Version	Changed since V5.0 FSR00 PUN25
Download Files		ICCCLEAR.UPG	00000128	—	N
		ICCEM.UPG	00000604	—	N
Operating System Files		VRTX OS	—	1.08	N
		IFX	—	1.11	N
		TNX	—	1.45	N
Options					
Ethernet	5.1.50	ETHERMGR.EXE	00007B0C	4.02	N
TeleRouter	5.1.50	TELERTE.EXE	00007ADA	4.00	N
MotorRouter	5.1.50	MOTORTE.EXE	00007ADA	5.00	Currently N/A
ISDN Options					
ISDN-NFAS	5.1.50	NFAS.EXE	00007B0C	5.00	N
ISDN-PRI	5.1.50	PRI.DWN	0089F678	6.11	N
ISDN-PRIN	5.1.50	PRIN.DWN	009330FA	6.11	N
NI-2	5.1.50	NI2.EXE	00007B0C	5.00	N
NTTPRI	5.1.50	NTTPRI.DWN	008E15D5	1.07	Y
NTDASS2	5.1.50	NTDASS2.DWN	009F44C9	3.08	N
DPNSS	5.1.50	DPNSS.DWN	00AB15B6	3.12	N
NET5	5.1.50	NET5.DWN	0086E64B	1.21	Y

Section 4

INSTALLING V5.1 SOFTWARE

4.1 INTRODUCTION

This section describes the procedures for installing Generic V5.1 FSR00 software.

Firmware should be brought up to the revision levels specified in *Section 3*.

CAUTION: This section provides detailed installation instructions for loading system software. Deviating from these instructions can result in lost data. Read all the material in this section prior to installing the software. If you encounter any problems during the installation, contact Summa Four.

To perform an upgrade of the system and/or optional software, you must take both redundant and non-redundant systems off-line for a brief period.

NOTE: To upgrade current system software to Generic V5.1, Generic V4.2 FSR00 or greater is required. If you are currently running V3.3.05 or V3.3.06, you must perform a two-stage upgrade: upgrade from V3.3.xx to V4.2.00, then from V4.2.00 to V5.1. A database conversion is required for each upgrade. Refer to Generic V4.2 Release Notes for possible upgrade restrictions.

Call Summa Four at 1-800-978-6642 or 1-603-695-1293 if you are running a version of the generic software prior to 4.2.00.

4.2 OVERVIEW OF THE INSTALLATION PROCEDURE

Redundant systems require software installation on both sides, and since the optional software varies from customer to customer, there will very likely be a slightly different path for each upgrade. If you follow the instructions sequentially and perform the tasks as they apply to your system, you will be assured of a successful installation.

Performing a database conversion is required when installing Generic V5.1 software, regardless of the software version from which your current database originated. The conversion utility is designed to determine what is required and to perform the appropriate conversions. If conversions are not required, no action is taken.

4.3 WHAT YOU NEED

You need the following software, hardware, and firmware to perform the installation:

Software

- Six (6) diskettes labeled as follows:

35008350151
FSR00 PUN00

VCO SYSTEMS V5.1
GENERIC V5.00
DISK x OF 6

NOTE: The x is a number from 1 to 6, indicating the sequence in which the diskettes must be loaded when you install the generic software. Only Disk 1 contains the installation utilities.

- Ethernet software
- MIB software

NOTE: No other optional software is included. If required, please call Summa Four at 1-800-978-6642.

Hardware

- AAC card Rev COUR (or later) is required for C-bus operation
- 68030 16MB CPU (or Combined Controller with 68030 16MB)

NOTE: Refer to Section 3, System Requirements, for detailed information.

Firmware

- 68030 CPU PROMs, ODD and EVEN V5.00 (or later)
- NBC-3 Card Boot V1.02

NOTE: Refer to Section 3, System Requirements, for detailed information.

Other

For redundant systems, be sure you can connect a system console to both system controllers. Depending on your equipment's arrangement, you can:

- Set up a separate system console for each controller (A- and B-side).
- Use an A/B transfer switch wired to both system controller CPU-TM front panels to switch access.
- Physically remove and reconnect the system console cable from one CPU-TM front panel to the other.

4.4 INSTALLING THE SOFTWARE

The following section provides instructions for installing Generic V5.1 software. Installation procedures for Ethernet and optional software follow the generic software installation.

NOTE: Before starting, make certain to back up your database.

On Disk 1, the Incremental Install Basic System Software option installs the generic software and downloads files onto the hard disk. This selection does not format the hard drive.

The instructions in the following subsections assume that the system console is connected to the CPU-TM of the side being installed.

NOTE: The MIB software is installed on the Host computer. Refer to Section 4.6.1, Installing the MIB Software. Do this after completing the installation of the generic software on the switch.

4.4.1 Installing the Generic Software

After confirming the hardware and firmware V5.1 requirements, as described in *Section 3*, install the new generic software on your system:

NOTE: Before beginning, power down the switch.

1. Insert Disk 1 into the floppy diskette drive (A-side if this is a non-redundant system, B-side if you are returning to this procedure to install software for that side).
2. Connect or switch the administration console to the A-side CPU-TM, or go to the A-side system console.
3. Power on the A-side.
4. After the system performs diagnostic tests, the Installation Utilities menu appears (*Figure 4.1*).
5. The cursor is located in the Enter Selection data entry field. Type **2**, (for Incremental Install of Basic System Software) then press **Return**.

The following message appears:

Do You Wish To Back-Up The System Data Base? (Y/N) =N?_

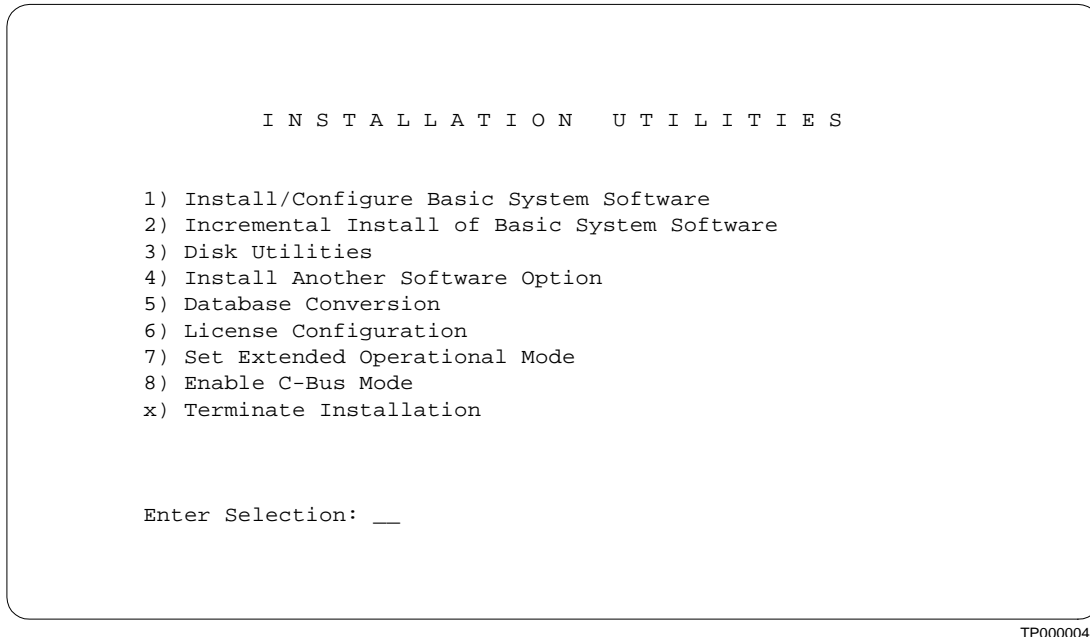

Figure 4.1: Installation Utilities Menu

6. Press **Return** (this defaults to N).

The database will not be backed up at this time. Make certain that the database was backed up previously.

7. The following message appears:

Insert disk 2 of Installation Set

Press return to continue

Remove the current diskette from the drive, insert Disk 2, and press **Return**. The system copies the files from Disk 2 to the C: drive in the /BOOT, /DBASE, /LOG and /TRACE directories.

8. When all the files from Disk 2 are copied, the following message appears:

Insert disk 3 of Installation Set

Press return to continue

Remove the current diskette from the drive, insert Disk 3 then press **Return**. The system copies the files from Disk 3 onto the C: drive.

9. This pattern, of the system copying from the diskette then prompting for the next, continues until all diskettes have been loaded and copied onto the system. Continue to remove and insert the installation diskettes when prompted to do so.

When the installation is complete, the Installation Utilities menu appears again (Figure 4.1).

10. If no optional software is to be installed, perform a database conversion now. (Refer to Section 4.4.2 for instructions.) If optional software is to be installed, proceed to Step 11.

11. Optional software needs to be installed every time you update the generic software to ensure NVRAM update. For options such as TeleRouter, ISDN-NFAS, or Ethernet, type **4**, Install Another Software Option, then press **Return**.

The following message appears:

Insert Another Install Disk

Press Return To Continue

Instructions for installing Ethernet for the Host and SNMP communications are contained in *Section 4.4.3*.

NOTE: When you install a software option (such as TeleRouter, etc.) on a system, the installation process makes changes to the non-volatile RAM (NVRAM) on the CPU. These changes make operation of software options specific to the CPU on which you installed the options. For this reason:

- *Software options must be installed on both system controllers in a redundant system.*
- *Software options must be reinstalled if the CPU is replaced.*

Because of the reliability of the CPU, failures requiring replacement are very rare occurrences.

4.4.2 Performing a Database Conversion

Performing a database conversion is required. To do this, select option **5** in the Installation Utilities menu.

The conversion takes a few seconds. The following message is displayed on the screen:

Data base path for conversion: C:/dbase/

If the database does not need to be converted, i.e., it had previously been converted, no other messages are displayed. However, if you do convert the database, several other messages may be displayed. For example:

Converting the System Configuration table ...

This will take just a few seconds.

If finished with the installation, press **X** for Terminate Installation.

4.4.3 Installing Ethernet for Host and SNMP Communication

You can install Ethernet software as part of the generic software installation or separately. For complete installation instructions, refer to the supplement provided with the Ethernet software.

The following section provides generalized instructions for installing the Ethernet optional software package. It is assumed that this step is being completed as part of the overall install and is being done as a continuation of *Installing the Software*.

To install and configure the Ethernet optional software, follow these steps:

1. Insert the Ethernet software diskette and press the **Return** key. After the system loads the Ethernet files from the diskette, the Ethernet Installation Utilities menu appears with the cursor located in the Enter Selection field, as shown in *Figure 4.2*.

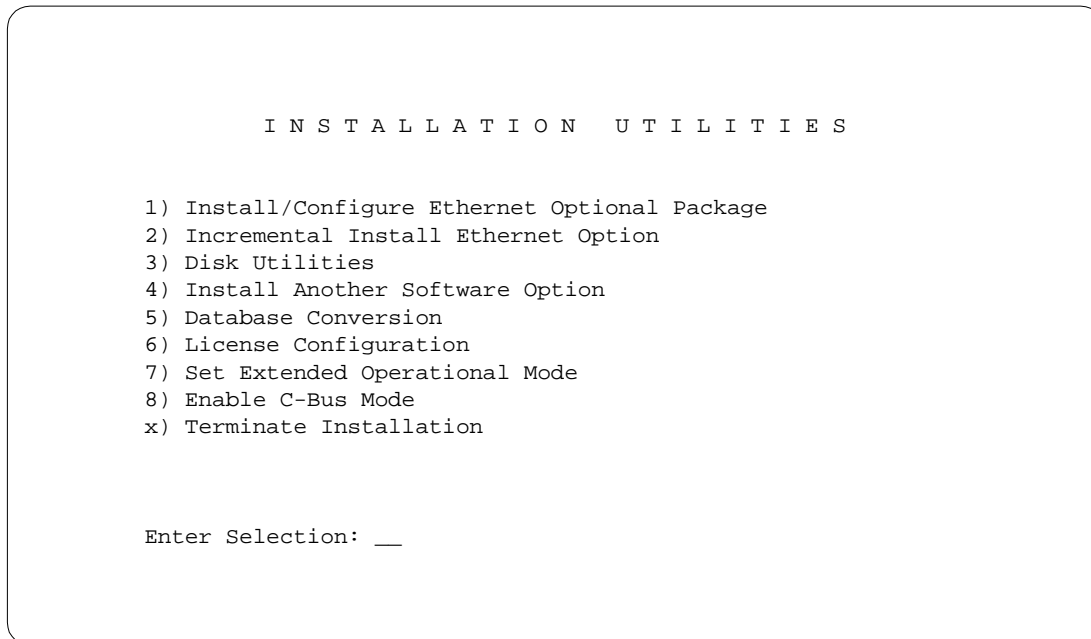

TP000070

Figure 4.2: Ethernet Installation Utilities Menu

2. To install and configure the Ethernet software, type **1** and press **Return**. The following message appears:

Do You Wish To Back-Up The System Data Base? (Y/N) =N?_

Press **Return** (this defaults to N). You will not be backing up the data base at this time.

The Ethernet Configuration menu appears (see *Figure 4.3*).

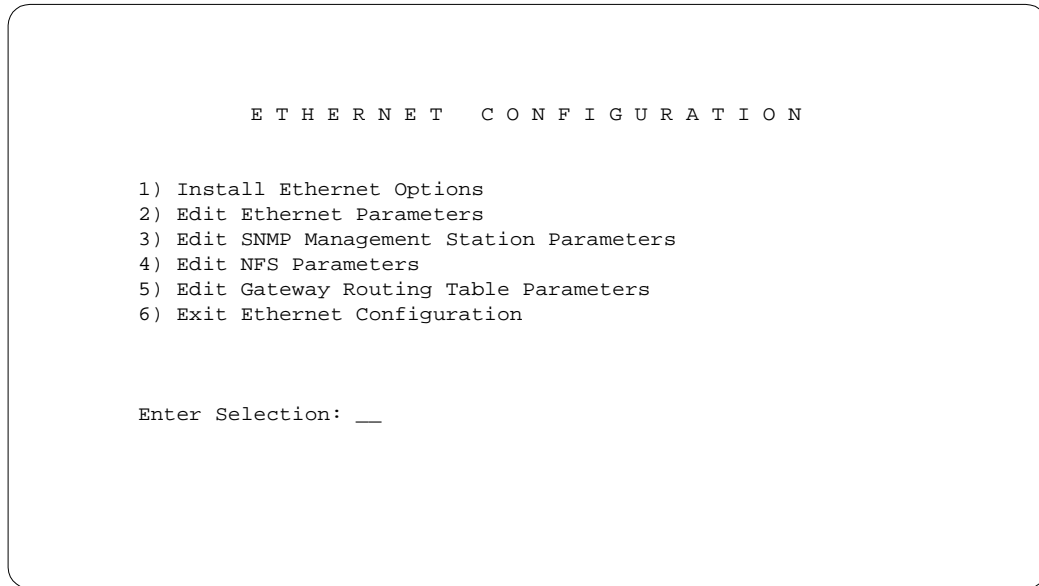

TP000019

Figure 4.3: Ethernet Configuration Menu

3. Type **1** and press **Return**. The following message appears:

Copy A:/BOOT/ETHERNET.EXE

1 files(s) copied

Ethernet Option Enabled

4. To set the Ethernet Parameters, type **2** and press **Return**. The following message appears:

System Internet Address = 107.3.254.98?

NOTE: The Ethernet and Internet address numbers that you see in the screen messages in this section are only examples. In your system these numbers are replaced by numbers that represent your system addresses.

5. Set the Internet Address of this system and press **Return**.

Set System Internet Address To 107.3.254.98 (Y/N) =Y?

6. If you change the address, you are prompted to confirm your new address. Type **Y** to confirm your selections. The following confirmation message appears:

System Internet Address Configured

7. Set the System Subnet Mask, or press **Return** to accept the displayed value.

After you complete this step, you can connect a remote console to your system via Telnet.

- a. If you are *not* going to manage this system with SNMP, go to Step 10.
- b. If you *are* going to manage this system with SNMP, type **3** and press **Return** to set the SNMP Management Station Internet address. The following message appears:

SNMP Management Internet Address = 0.0.0.0?

8. Set the Internet address to the address of the system that you are using as the NMS (Network Management System). Press **Return**. The following message appears:

Set SNMP Management Internet Station Address To 189.7.107.44 (Y/N) =Y?

9. Type **Y** to confirm your selections. The following confirmation message appears:

SNMP Management Station Internet Address Configured

After you complete this step, the system will report SNMP trap messages to the NMS that you selected.

- a. If you are not going to boot your system over the network, go to Step 12
 - b. If you are going to boot your system over the network, continue with Step 10.
10. Type **4** to set the Network File System (NFS) server parameters. The following selections appear one at a time. Enter the information for your system. Type **Y** and press **Return** after each selection.

Enable NFS Access (Y/N) =Y?

NFS Server Internet Address = 000.0.000.000?

NFS Server Name =xxx?

NFS Mount Directory Point #?

Target System Name =

Target System User Id =

Target System Group Id =

Target System Umask =

Update NFS Configuration With Above Data (Y/N) =Y?

11. After you update the NFS configuration with the new data, the following message appears:

NFS Configuration Updated

You can now save the log files and database to a remote location.

Type **6** to exit and press **Return**. The Installation Utilities screen appears (see *Figure 4.2*).

12. To end the Ethernet installation, and if no optional software is to be installed, type **7** and press **Return**. If optional software is to be installed, see *Step 14*.
13. Remove the Ethernet diskette from drive A.
14. If additional optional software is to be installed, press **4**.

4.5 INSTALLING THE SOFTWARE ON THE B-SIDE

If you have a redundant system, repeat all the steps in *Section 4.4, Installing the Software*.

If you do not have a redundant system, proceed to *Section 4.6.1, Installing the MIB Software*.

4.5.1 Verifying File Synchronization

For redundant systems, after you have installed the software on both sides and rebooted the system, you must verify that file synchronization has occurred. Check the messages at the bottom of the screen until you see:

ACT FILE SYNC COMPLETED

NOTE: This message may be replaced by subsequent messages before it can be seen. Check the active and standby log files to confirm completion.

When file synchronization has been verified, the installation of system software is complete. Proceed to the next section to install the MIB software.

4.6 SNMP

If you use SNMP (Simple Network Management Protocol) to manage your switch, install the MIB software on your network management system. Otherwise, you are finished with the installation process.

NOTE: You must download and use the MIB file shipped with the V5.1 software release as MIB files are not backward compatible.

Summa Four provides snmptalk on the MIB disk but does not support the application. It runs on the SUN operating system only.

4.6.1 Installing the MIB Software

To move the MIB software which is provided on the MIB - Supplemental Disk to a network management system:

1. Place the MIB - Supplemental Disk in the floppy drive of the Host computer.

Note that snmptalk is a SunOS executable file and is usable only on SunOS computers. The three other files can be used on a non-SunOS platform.

2. Create a directory in which the MIB files are to reside. Define the location and name of the directory.
3. Move the files from the disk into the new directory created in *Step 2*.

NOTE: All four files must reside in the same directory.

4.6.2 Setting up snmptalk

Once you invoke the snmptalk program, you need to enter the following setup information so it can communicate with your system. Prior to doing the setup, you need to know the Internet Protocol (IP) address of your system.

Table 4.1 snmptalk Setup Commands

Command	Meaning
v 1	Use to select the SNMP Version 1 mode
write-comm public	Use to set write community to "public"
dest <i>nnn.nnn.nnn.nnn</i>	Use to enter the IP address of the VCO (where <i>nnn.nnn.nnn.nnn</i> is the IP address)
?	Use to provide a list of the commands available
get sysUpTime.0	Example of get command
tset sysLocation.0 string here	Example of set command
quit	use to exit program

NOTE: This program cannot handle white space or quotes, so you must enter commands without spaces. This is a limitation of the basic test program.

The vco.mib file is the ASN.1 notation MIB for the V5.1 system. This file can be compiled by a SNMP Network Management Station and used to provide the management station with information on the VCO MIB structure. The information in this file is also listed in the *VCO V4.2 Management Information Base (MIB) Reference Guide*.

4.6.3 Public Access

The community names for read and write access must be set to public for a NMS to properly access the Summa Four Enterprise MIB.

4.7 SETTING EXTENDED OPERATIONAL MODE

Perform the following steps to set the switch for extended mode.

1. Back up the database(s).

WARNING: A backed up standard mode database is required to return to standard mode, if needed.

2. Bring down the switch.
3. Insert Install Disk 1.
4. Go to the Installation Utilities screen and press **7** for Set Extended Operational Mode.
5. A Setting the Operational Mode To Extended Mode. Are you sure (Y/N) =N? prompt is displayed. Type **Y**. If unsure, type **N**.
6. Bring up the switch.
7. Verify that Extended Operational Mode is set: Go to the System Features screen and view the Extended Operational Mode Set field. If set for extended operation, this field should display **Y**.

NOTE: Be sure to change both sides in a redundant system.

4.8 RESETTING TO STANDARD MODE

The system does not allow the operational mode to be set back to standard once it has been set to extended. This is due to larger values which could be set in extended mode and are not valid in standard mode.

The mode is stored in one of the database files. If you must return to standard mode during testing, do so by reverting to the saved database files which were copied before you set the extended mode.

4.9 ENABLE C-BUS

Refer to *Section 2.5.1* for instructions on how to enable the C-bus.

Section 5

LIVE UPGRADE PROCEDURE

5.1 INTRODUCTION

This section describes the procedures for installing Generic V5.1 FSR00 on systems currently running V4.2 FSR00 or greater, or V5.0 FSR00 or greater, of the generic software. To upgrade current system software to Generic V5.1, Generic V4.2 FSR00 or greater is required. If you are currently running V3.3.05 or V3.3.06, you must perform a two-stage upgrade: upgrade from V3.3.xx to V4.2.00, then from V4.2.00 to V5.1. A database conversion is required for each upgrade. Refer to Generic V4.2 Release Notes for possible upgrade restrictions.

Use the Live Upgrade option to update software on a redundant VCO or SDS Series system without loss of calls, and with a minimum reduction in capacity. The procedure consists of:

- installing the new software,
- updating the system controller (CPU card) and/or NBC-3 card and/or DTG-2 card (if needed),
- switching over to the new release, and
- updating certain network and service circuit cards (if needed).

You can abort the process at any time and restore the prior version until the time when the active controller is running the new release of software. To revert to the prior release of software after the active controller is running the new software, you must perform a non-live (manual) installation of the prior release.

NOTE: Live upgrade does not support SS7 upgrade. Following a live upgrade to the generic software, systems that are not configured to reset upon a system controller reset require manual reset of the Sparc. The SS7 system must also be configured to auto-start the SS7 software.

It is important that you note the following guidelines and restrictions to ensure a successful live upgrade.

- Call Summa Four at 1-800-978-6642 or 1-603-695-1293 if you are running a version of the generic software prior to 4.2.00.
- DO NOT perform a live upgrade if you are currently running V4.2 FSR00 PUN24. Upgrading from V4.2 FSR00 PUN24 must be done manually.
- A live upgrade cannot be performed if you are currently running V5.0 FSR50 PUN21. Upgrading from V5.0 FSR50 PUN21 must be done manually.
- This section provides detailed installation instructions for loading system software and upgrading hardware. Deviating from these instructions can result in lost data. Read all material in this section prior to installing the software. If you encounter any problems during the installation, contact Summa Four Technical Support at the number listed above.

5.2 PREPARE FOR LIVE UPGRADE

Note the following when performing a live upgrade:

- Calls can be continued during the live upgrade.
- Live upgrade can be performed only on a redundant system. Non-redundant systems must be upgraded with the manual upgrade described in Section 4.
- The switch operates in non-redundant mode during much of the live upgrade procedure. This period of non-redundancy has been minimized as much as possible.
NOTE: When upgrading software on the switch, the software is upgraded on the CPU. The active or standby side of a system refers to the CPU or controller.
- The system administrator is prevented from modifying the configuration of the switch during the live upgrade procedure.
- If the upgrade includes hardware, firmware, or software for a card that is a single resource, there may be an interruption of service that is provided by that resource.
- Perform the live upgrade when call traffic is lowest; the switch cannot operate at full capacity during the live upgrade. Also note that, should the live upgrade fail, upgrading during low volume periods would affect the least number of calls.
- 20MB disk space must be available on each controller's hard drive to perform the live upgrade. Go to Maintenance/Disk Utilities/Show Free Disk Space on the master console for disk space availability.
- The live upgrade procedure automatically checks the free space on both hard drives and if there is a shortage of space, it aborts the live upgrade and reports the problem to both the regular log file and live upgrade log file. Live upgrade log file error messages and corrective action are contained in *Appendix B*. Regular log file error messages and corrective action are contained in *Appendix D* of the *System Administrator's Guide*.
- Modifications to the database are not allowed during the live upgrade. Do not remove cards from the switch unless directed to do so as part of the upgrade process.

- Control of the upgrade may be done via:
 - Local via serial port (master console)
 - Telnet session (Ethernet or serial PPP)
 - Modem port

NOTE: Hardware and/or firmware updates require on-site personnel. In this case, the live upgrade cannot be done remotely.

- Live upgrade cannot be performed if replacement of the Alarm Arbiter Card (AAC) is required.

All log information about the live upgrade is sent to the regular log file and to the live upgrade log file (of both hard drives). Also, Prompt, Warning, and Error messages appear in the lower, right-hand corner of the master console screen when you execute various live upgrade steps from the Live Upgrade Control Menu.

The format of the regular log file is C:/LOG/A-mmmdd.LOG and C:/LOG/B-mmmdd.LOG. These two file names will be on both hard drives. However, keep in mind that A-mmmdd.LOG and B-mmmdd.LOG files on the A-side hard drive are different from A-mmmdd.LOG and B-mmmdd.LOG files on the B-side hard drive.

The format of the live upgrade log file is C:/LOG/UGmmddy.LOG. This log is similar to the regular log, but is written only during upgrade and reflects the upgrade in progress. Note that the filename contains the month, day, and year of the update in the format mmddy. To display and print the log file, select the Display/ Print Upgrade Log menu option. This filename will be on both hard drives. However, keep in mind that C:/LOG/UGmmddy.LOG file on the A-side hard drive is different from C:/LOG/UGmmddy.LOG file on the B-side hard drive.

For information on how to display the regular log file on the screen, refer to the Maintenance section of the *System Administrator's Guide*.

For information on how to display the live upgrade log file on the screen, refer to this procedure.

NOTE: If a printer is connected to the system while the live upgrade is in progress, both the regular and live upgrade log files are printed. Live upgrade log file messages appear indented with respect to the regular log file messages.

Regular log file entries pertaining to live upgrade consist of an ALM15x message imbedded in an FRM5xx message.

Live upgrade log file entries pertain only to live upgrade and do not contain ALM15x and FRM5xx headers.

- You can abort the upgrade up to the point where the active CPU running the old version of the software switches control over to the standby CPU running the new version of the software.
- New messages related to the live upgrade are contained in *Appendix B*.

5.3 LIVE UPGRADE ACCESS

To upgrade a system via live upgrade, you need to perform some or all of the following four basic tasks (tasks 1 and 3 are mandatory).

1. Follow the live upgrade procedure to upgrade the software on both sides of the system. Install the generic and optional software.
2. Update the CPU, and/or the NBC-3, and/or DTG/DTG-2, if needed.
3. Switch over to the new software release.
4. Update certain network and/or service circuit cards, if needed.

To access the Live Upgrade Control Menu screen, as shown in *Figure 5.1*, from the Maintenance menu, press L. The cursor is located at the Enter Selection field.

```
                L I V E   U P G R A D E   C O N T R O L   M E N U

A) Prepare for Install
B) Install New Release
C) Prepare for Live Upgrade
D) Enable/Disable/Configure Optional S/W
E) Update Generic
F) Switchover to Standby
G) Cutover Port and Service Cards
H) Database Store (Backup)
I) Post Live Upgrade Cleanup
J) Abort Live Upgrade
K) Display/Print Live Upgrade Log

Enter Selection (A,H,K): __

#00 Fri Sep 11, 1998  16:01  A-USB  B-UAC
```

TP000112

Figure 5.1: Live Upgrade Control Menu

Screen selections are limited to the appropriate letter for the current step as indicated as part of the Enter Selection prompt. In *Figure 5.1*, valid selections are A, H, and K.

The system lets you know that a live upgrade is in progress by displaying UAC or USB at the bottom of the screen; UAC indicates Upgrade Active mode and USB indicates Upgrade Standby mode. As shown in *Figure 5.1*, side A is in standby mode and side B is active.

5.4 LIVE UPGRADE PROCEDURE OVERVIEW

An overview of the steps required to perform a live upgrade are listed in *Table 5.1*, as well as which option to select from the Live Upgrade Control Menu, and the actions taking place within the system. A detailed description of the steps begin in *Section 5.5*.

Table 5.1 Live Upgrade Procedure Overview

Step	Screen Selection	Action
1	Option A	Prepare for the installation of the new release on active and standby sides — Directories that are needed for the process are automatically created. The current release on each side of the system is backed up.
2	Option H	Back up the existing database on the active and standby sides.
3	Option B	Install the new software on the active and standby sides — The system installs the necessary files on each controller of the switch.
4	Option C	Prepare for the upgrade on the standby side — The system is set up to boot from the new release. Suitability of system to accept the release is checked.
5	Option D	Enable/disable/configure optional software (Ethernet, ISDN, NFAS, TeleRouter) on the standby side.
6	Option E	Update the generic software on the standby side — The system automatically reboots the standby side with the new release and performs a database conversion. The system synchronizes the dynamic information.
		Standby side reboots and NBC downloads
7	Option F	Switch the active side to standby — The alternate side is updated. <i>NOTE: After this step is complete, you can no longer abort the upgrade. Repeat steps 4 to 6 on the standby controller.</i>
8	Option C	Prepare for the upgrade on the active side — The system is set up to boot from the new release. Suitability of the system to accept the release is checked.
9	Option D	Enable/disable/configure optional software (Ethernet, ISDN, NFAS, TeleRouter) on the active side.
10	Option E	Update the generic software on the active side — The system automatically performs a database conversion. The system synchronizes the dynamic information.
		Wait for file synchronization.
11	Option G	Cut over port and service cards on the active side — The system switches over the port and service cards.
12	Option H	Back up the new databases on the active and standby sides.
13	Option I	Clean up the active and standby sides.

5.5 PERFORM A LIVE UPGRADE

The following is a detailed explanation of the steps outlined in *Table 5.1*. Follow these steps to perform a live upgrade on your system. When referring to Option x (where x signifies the option letter from the Live Upgrade Control Menu screen), you are directed to select the appropriate option from the Live Upgrade Control Menu screen. For example, Option A directs you to select the Prepare for Install option.

5.5.1 Step 1: Prepare for Installation of New Release

Option A—Prepare for Install

This step must be performed on both controllers (active and standby side).

To initiate installation of both the active and standby sides, select the Prepare for Install option on the Live Upgrade Control Menu; type **A** then press **Enter**.

The installation routine determines if the disk has enough free space to create a new directory structure and store the new files. If a shortage of disk space is detected, you are notified and the upgrade is automatically aborted.

If you do not have enough free space to perform the upgrade and are unsure of the disk maintenance necessary to obtain it, contact Summa Four Technical Support at 1-800-978-6624 or 1-603-695-1293.

The directory structure that is required by the upgrade process is shown in *Figure 5.2*. The directories created for the upgrade procedure are shown in bold; they are automatically created by the generic software when you select the Prepare for Install option. If they already exist, any existing files are removed from the directories. The directories themselves are maintained, and are used during the upgrade process.

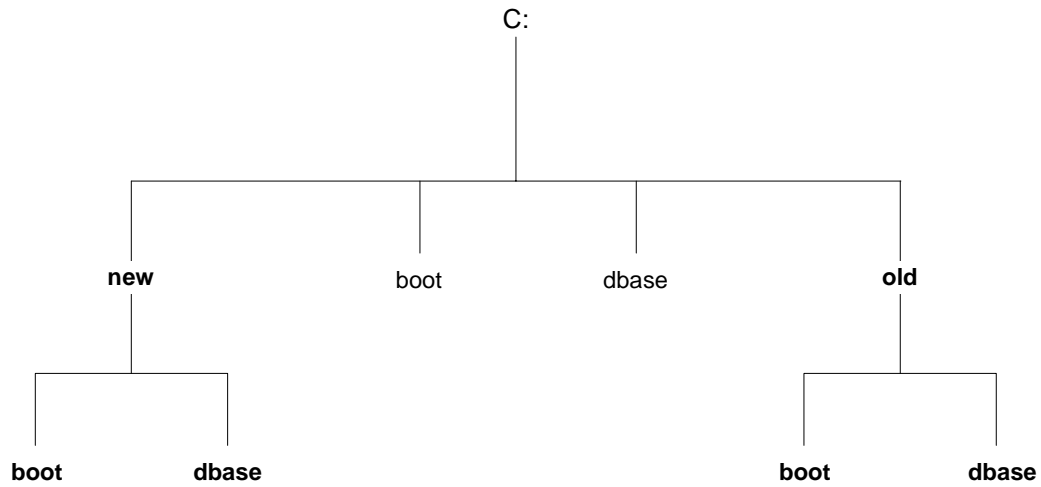

TP000114

Figure 5.2: Upgrade Process Directory Structure

The directory and its purpose are:

- C:/new/boot The new executable files and download application files.
- C:/new/dbase The new, empty database.
- C:/old/boot The current software release. The current generic software is restored from this directory if you select the Abort Upgrade option from the Live Upgrade Control Menu.
- C:/old/dbase The current database. The current database is restored from this directory if you select the Abort Upgrade options from the Live Upgrade Control Menu.

NOTE: You can abort the upgrade at this time: Select option J from the Live Upgrade Control Menu.

5.5.2 Step 2: Back up the Existing Database

Option H—Database Store (Backup)

The first step in the live upgrade process is to back up the existing database. *Do this before proceeding to the next step.* You must perform this step on both system controllers. Also note that back up of a standby controller is allowed only during live upgrade.

You should back up your current database in case it is necessary to restore the previous generic software version from floppy diskette. The backup database option on the Live Upgrade Control Menu is similar to the manual database backup utility.

To back up your existing database, press **H**. The Store from C:/ to A:/ YES/NO _ prompt appears. Press **Y** to continue with the database backup process.

NOTE: You can abort the upgrade at this time: Select option J from the Live Upgrade Control Menu.

5.5.3 Step 3: Install the New Software

Option B—Install New Release

After the new directories are created and you have performed a database backup, install the new generic software and database in the appropriate directories on the internal hard drive of both active and standby system controllers.

Install the new software from floppy diskettes, or from another host with FTP or FTP and PPP, if Ethernet or a modem connection is available and FTP is supported within the system controller software. The files are copied to the subdirectories under the C:/new directory.

Perform Step 3 on *both* system controllers before proceeding to the next step. After completing Step 3 on both controllers, continue the upgrade process on the standby controller. No further activity is performed on the active controller until you have upgraded the standby controller.

NOTE: You can abort the upgrade at this time: Select option J from the Live Upgrade Control Menu.

Install from Floppy Diskettes

When you select the Install New Release option from the Live Upgrade Control Menu, the VCO Installation screen is displayed as shown in *Figure 5.3*.

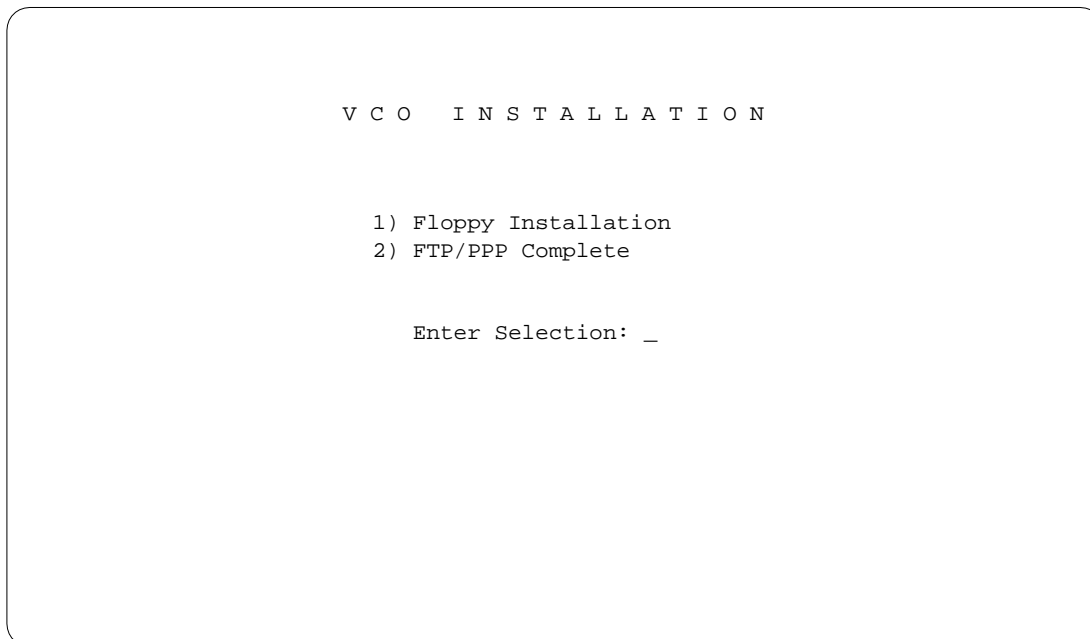

TP000115

Figure 5.3: VCO Installation Screen

To install from floppy diskettes, type **1**, then press **Enter**. The VCO Floppy Installation screen is displayed, as shown in *Figure 5.4*.

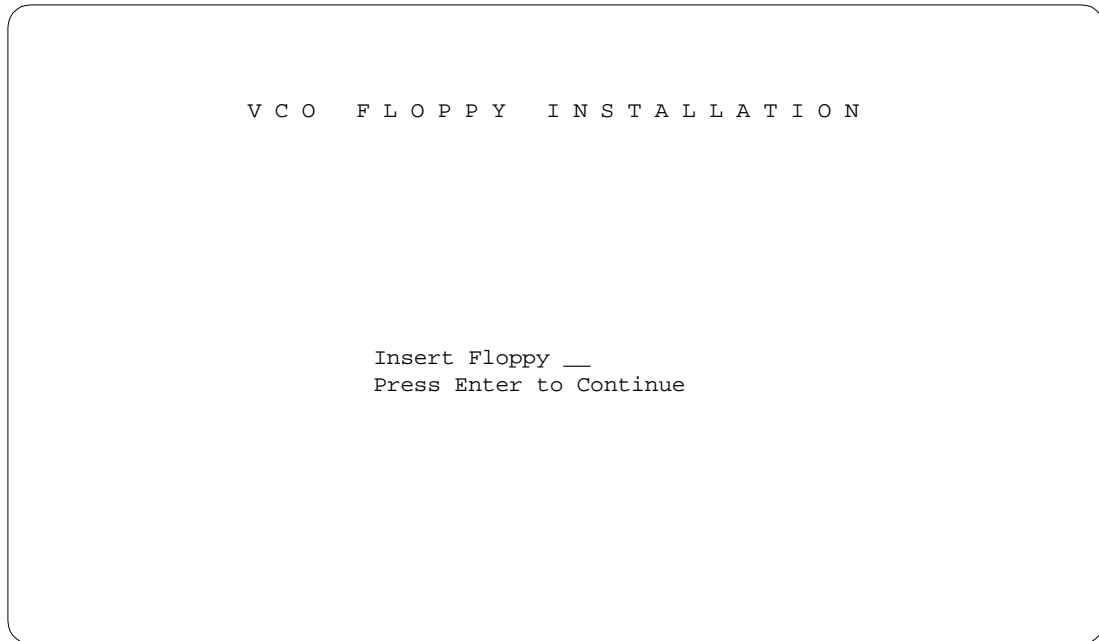

TP000116

Figure 5.4: VCO Floppy Installation Screen

You are prompted to insert the installation diskettes into the floppy drive so that the files can automatically be transferred into the appropriate directories. Press any key other than **Enter** or **Return** to stop the loading of files from the floppy drive.

The floppy diskette number is displayed in the VCO Floppy Installation screen; for example, Insert Generic Floppy 1. When you insert the floppy diskette the volume label is verified. Your response (for example, if you pressed the **Enter** key to continue) is logged in the upgrade log file along with the files that are being installed. If any files are missing from the floppy, or if there is a mismatch, the upgrade is aborted.

After all software diskettes have been installed, you are prompted to install optional software as shown in *Figure 5.5*. If no other software is to be installed, select option **2: Installation Complete**, shown in *Figure 5.5*, and press **Enter** to exit the installation.

Install Optional Software

After the generic software is installed, you can install optional software package files; refer to *Figure 5.5*.

To install an optional software package:

- Select Option 1: Install Optional Software.
Type **1** in the Enter Selection field, then press **Enter**.
- After inserting the floppy diskette into the disk drive, press **Enter**.

After completing the installation of an option, the menu in *Figure 5.5* appears again. Select Option 1 again to install another software package, or select Option 2: Installation Complete, to terminate the installation.

In a separate step, you must enable and configure the optional software; refer to *Install from Another Host*.

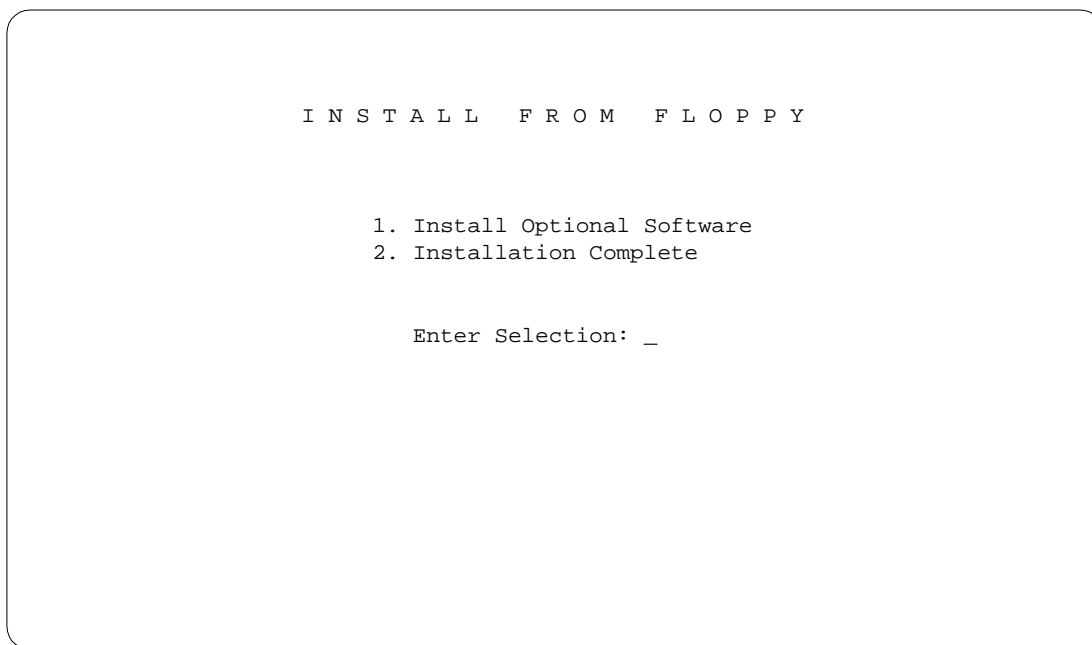

TP000117

Figure 5.5: Install from Floppy Screen

Install from Another Host

If you install the software from a remote computer through FTP via Ethernet, or PPP, you control the process from the FTP client. You are required to select the needed files and copy them to the appropriate subdirectories under the C:/new directory. This option assumes that you know how to FTP files from your host computer to the VCO system.

When the FTP transfer of the new generic software to the hard disk is complete, you must indicate that the transfer is complete by selecting Option 2 in the VCO Installation screen; refer to *Figure 5.3* on page 8. The generic software then verifies that the transfer is complete. Successful transfer is indicated by the Check for all Files Successful message.

5.5.4 Step 4: Prepare for the Upgrade

Option C—Prepare for Live Upgrade

On the standby side of the system, select the Prepare for Live Upgrade option from the Live Upgrade Control Menu. Type **C** then press **Enter**. You perform this step later on the other side of the system; refer to *Step 8: Prepare to Upgrade the Remaining Side*.

During this step, the generic software automatically performs several tasks and verifies that:

- The side being upgraded in this step is in standby mode and that the alternate side is active and running.
- The file synchronization (static database and dynamic state information) has completed.
- The new software release has been placed in the C:/new directory on the hard drive and that all needed files are available for the upgrade.
- The version number of the software release being installed is newer than the current software release.
- The switch configuration is suitable for the upgrade.

NOTE: If the configuration is not suitable, information is logged and the upgrade is prohibited.

You are notified if there are single resources in the system that require updating. Note that updating a single resource causes a loss of capacity for that resource. Refer to *Section 5.5.15*, for live upgrade messages.

When verification of the preceding has been successfully completed, the existing generic software and the switch configuration is copied to the C:/old directory. Finally, the generic software copies the new boot files from C:/new/boot into the current boot area, C:/boot. During this and later steps, you are locked out from making any configuration changes on the system.

NOTE: You can abort the upgrade at this time: Select option J from the Live Upgrade Control Menu.

5.5.5 Step 5: Enable/Disable/Configure Optional Software

Option D—Enable/Disable/Configure Optional S/W

This step is optional. If you do not have optional software, skip this step.

To initiate step 5, select the Enable/Disable/Configure Optional S/W option from the Live Upgrade Control Menu; type **D** then press **Enter**. The screen shown in *Figure 5.6* is displayed. Perform this step on the standby side of the system.

NOTE: The only the optional software packages that have been installed are shown in the Enable/Disable/Configure Optional S/W screen.

This step consists of two parts; 1) enabling the options, and 2) configuring the options.

```
          E N A B L E / D I S A B L E / C O N F I G U R E
                O P T I O N A L   S O F T W A R E

          A) Enable Ethernet
          B) Disable Telerouter
          C) Enable ISDN
          D) Enable NFAS
          E) Enable NI-2

          Enter Selection: _

#00 Fri Sep 11, 1998 16:41  A-USB B-UAC
```

TP000163

Figure 5.6: Enable/Disable/Configure Optional Software Screen

You can enable or disable software depending on its current state. For instance, note in *Figure 5.6* that the only software package enabled is TeleRouter, since the option for TeleRouter is to Disable. All other options are to Enable, thereby indicating that the other software packages (Ethernet, ISDN, NFAS, NI-2) are currently disabled.

If you select the Enable Ethernet option, you are prompted to set the parameters. The Ethernet configuration process is the same as the manual Ethernet configuration process, i.e., installing Ethernet using the Ethernet Install diskette.

NOTE: You can abort the upgrade at this time: Select option J from the Live Upgrade Control Menu.

5.5.6 Step 6: Update the Generic Software

Option E—Update Generic

Perform this step on the standby side of the switch. This step results in an update of the generic software.

NOTE: The system is non-redundant from the time you start the update of one side (step 6) until the time that new release is running on both sides of the system. Once both sides are running the new release of software, the system returns to a redundant mode of operation.

Any hardware or firmware upgrades required on the standby NBC-3, the DTG-2 card on the standby NBC-3, and/or the standby CPU should be done before initiating step 6. Refer to the following subsections for information on upgrading the firmware and/or hardware before proceeding.

To initiate step 6, select the Update Generic option on the Live Upgrade Control Menu; type **E** then press **Enter**.

When the Update Generic option is selected:

1. the standby side is rebooted
2. the new generic software performs a database conversion (if needed)
3. a login screen appears on the console.

Update the CPU

To upgrade the CPU, select option **E**, Update Generic, and press **Enter**. Once the CPU reboots, you may remove the CPU card for upgrading.

NOTE: A CPU card which is housed in a combined controller carrier may be removed from the card cage while under power. If the CPU is not housed in a combined controller carrier, you must first remove the power to the standby CPU. Refer to the Technical Description: Central Processing Unit for removal and replacement procedures.

After upgrading the hardware/firmware, insert the CPU card into the system and restore power if it had been previously powered off.

Update the NBC-3 Card

If the hardware or firmware of the NBC-3 card needs to be replaced, it should be done at this time. An NBC-3 card that is in standby mode can be removed while the system is running.

Note that when the NBC-3 card is removed, a DTG-2 card mounted on that NBC-3 is consequently also removed and updated (see the following subsection). If the DTG-2 card is the only tone generator in the switch, the system will experience a loss of tone generation resources while the NBC-3 and/or DTG-2 is upgraded. Refer to the *Technical Description: NBC-3* for removal and replacement procedures.

To upgrade the NBC-3, select option **E**, then press **Enter**. Once the CPU reboot process starts, the NBC-3 may be removed and upgraded. After restoring the NBC-3 card, reset the standby CPU via the Alarm Arbiter Card.

Update the DTG-2 Card

NOTE: If your system has a DTG card, it does not get updated at this time.

If the hardware or firmware of the DTG-2 card needs to be replaced, you should do it at this time. You must take the DTG-2 out of service (OOS) when its firmware or hardware is updated.

Upgrade the DTG-2 mounted on the standby NBC-3, even if it is the active tone card. If your system has redundant tone cards, assure that the DTG-2 card on the standby NBC-3 is in standby mode. If the system does not have redundant DTG-2 cards, note that the system will experience a loss of tone generation resources while the DTG-2 is upgraded.

To upgrade the DTG-2, select option **E**, then press **Enter**.

When you upgrade your generic software via live upgrade, the system performs an automatic database conversion as part of the upgrade.

Database Conversion

When the new generic software is running, a database conversion is automatically performed by the software. The converted files are updated in the C:/dbase directory and loaded into memory as the static portion of the new database. Any new tables needed for the upgrade are obtained from the C:/new/dbase directory. Note that some upgrades may *not* require a database conversion.

*NOTE: You can abort the upgrade at this time: Select option **J** from the Live Upgrade Control Menu.*

5.5.7 Step 7: Switch the Active Side to Standby

Option F—Switch to Standby

In step 7, place the active side (controller) in standby mode. When this is done, the previously active side, running the old generic software, becomes available to upgrade. In addition, the side which was in standby mode will become active and be running the new software.

To initiate this step, on the active side of the system, choose the Switchover to Standby option from the Live Upgrade Control Menu; type **F** then press **Enter**.

NOTE: Make certain your console is on the active side of the switch when performing the switchover.

CAUTION: When this step is complete, the upgrade can no longer be aborted. If restoring the old software release is required, you must perform a traditional reinstallation of the original software.

Once the switchover has taken place, i.e., the reboot and NBC download are complete, your console should be on the standby controller's side (the controller that needs to be updated).

5.5.8 Step 8: Prepare to Upgrade the Remaining Side

This is a repeat of the steps already performed on the other side, described in *Section 5.5.4*. This now becomes the new standby side of the system. Select the Prepare for Live Upgrade option from the Live Upgrade Control Menu. Type **C** then press **Enter**.

During this step, the generic software automatically performs several tasks and verifies that:

- The side being upgraded in this step is in standby mode and that the alternate side is active and running.
- The file synchronization (static database and dynamic state information) has completed.
- The new software release has been placed in the C:/new directory on the hard drive and that all needed files are available for the upgrade.
- The version number of the software release being installed is newer than the current software release.
- The switch configuration is suitable for the upgrade.

NOTE: If the configuration is not suitable, information is logged and the upgrade is prohibited.

You are notified if there are single resources in the system that require updating. Note that updating a single resource causes a loss of capacity for that resource. Refer to *Section 5.5.15*, for live upgrade messages.

When verification has been successfully completed, the existing generic software and the switch configuration is copied to the C:/old directory. Finally, the generic software copies the new boot files from C:/new/boot into the current boot area, C:/boot. During this and later steps, you are locked out from making any configuration changes on the system.

NOTE: The upgrade can no longer be aborted.

5.5.9 Step 9: Enable/Disable/Configure Optional Software

Option D—Enable/Disable/Configure Optional S/W

This step is optional. If you do not have optional software, skip this step.

To initiate step 9, select the Enable/Disable/Configure Optional S/W option from the Live Upgrade Control Menu; type **D** then press **Enter**. The screen shown in *Figure 5.6* is displayed.

NOTE: The only the optional software packages that have been installed are shown in the Enable/Disable/Configure Optional S/W screen.

This step consists of two parts; 1) enabling the options, and 2) configuring the options.

You can enable or disable software depending on its current state. For instance, note in *Figure 5.6* that the only software package enabled is TeleRouter, since the option for TeleRouter is to Disable. All other options are to Enable, thereby indicating that the other software packages (Ethernet, ISDN, NFAS, NI-2) are currently disabled.

If you select the Enable Ethernet option, you are prompted to set the parameters. The Ethernet configuration process is the same as the manual Ethernet configuration process, i.e., installing Ethernet using the Ethernet Install diskette.

NOTE: The upgrade can no longer be aborted.

5.5.10 Step 10: Update the Generic Software

Option E—Update Generic

Perform this step on the standby side of the switch. This step results in an update of the generic software.

NOTE: The system is non-redundant from the time you start the update of one side (step 6) until the time that new release is running on both sides of the system. Once both sides are running the new release of software, the system returns to a redundant mode of operation.

Any hardware or firmware upgrades required on the standby NBC-3, the DTG-2 card on the standby NBC-3, and/or the standby CPU should be done before initiating step 10. Refer to the following subsections for information on upgrading the firmware and/or hardware before proceeding.

To initiate step 10, select the Update Generic option on the Live Upgrade Control Menu; type **E** then press **Enter**.

When the Update Generic option is selected:

1. the standby side is rebooted
2. the new generic software performs a database conversion (if needed)
3. a login screen appears on the console.

Update the CPU

To upgrade the CPU, select option **E**, Update Generic, and press **Enter**. Once the CPU reboots, you may remove the CPU card for upgrading.

NOTE: A CPU card which is housed in a combined controller carrier may be removed from the card cage while under power. If the CPU is not housed in a combined controller carrier, you must first remove the power to the standby CPU. Refer to the Technical Description: Central Processing Unit for removal and replacement procedures.

After upgrading the hardware/firmware, insert the CPU card into the system and restore power if it had been previously powered off.

Update the NBC-3 Card

If the hardware or firmware of the NBC-3 card needs to be replaced, it should be done at this time. An NBC-3 card that is in standby mode can be removed while the system is running.

Note that when the NBC-3 card is removed, a DTG-2 card mounted on that NBC-3 is consequently also removed and updated (see the following subsection). If the DTG-2 card is the only tone generator in the switch, the system will experience a loss of tone generation resources while the NBC-3 and/or DTG-2 is upgraded. Refer to the *Technical Description: NBC-3* for removal and replacement procedures.

To upgrade the NBC-3, select option **E**, then press **Enter**. Once the CPU reboot process starts, the NBC-3 may be removed and upgraded. After restoring the NBC-3 card, reset the standby CPU via the Alarm Arbiter Card.

Update the DTG-2 Card

NOTE: If your system has a DTG card, it does not get updated at this time.

If the hardware or firmware of the DTG-2 card needs to be replaced, you should do it at this time. You must take the DTG-2 out of service (OOS) when its firmware or hardware is updated.

Upgrade the DTG-2 mounted on the standby NBC-3, even if it is the active tone card. If your system has redundant tone cards, assure that the DTG-2 card on the standby NBC-3 is in standby mode. If the system does not have redundant DTG-2 cards, note that the system will experience a loss of tone generation resources while the DTG-2 is upgraded.

To upgrade the DTG-2, select option **E**, then press **Enter**.

When you upgrade your generic software via live upgrade, the system performs an automatic database conversion as part of the upgrade.

Database Conversion

When the new generic software is running, a database conversion is automatically performed by the software. The converted files are updated in the C:/dbase directory and loaded into memory as the static portion of the new database. Any new tables needed for the upgrade are obtained from the C:/new/dbase directory. Note that some upgrades may *not* require a database conversion.

5.5.11 Verifying File Synchronization

For redundant systems, after you have installed the software on both sides and rebooted the system, you must verify that file synchronization has occurred. Check the messages in the log file and verify that the RED32:ACT FILE SYNC COMPLETED (from the active side) and RED20:SBY FILE SYNC COMPLETED (from the standby side) messages appear.

When you have verified file synchronization, the installation of system software is complete. Proceed to **Section 5.xx** to install the MIB software if you have a Network Management System.

NOTE: You cannot abort the upgrade at this time.

5.5.12 Step 11: Cutover of Port and Service Cards

Option G—Cutover Port and Service Cards

Once the new release is running on both sides of the system and the file synchronization is complete, cut over the port and service cards that need to be upgraded, from the active side of the system.

To initiate step 11, on the active side of the system, select the Cutover Port and Service Cards option from the Live Upgrade Control Menu; type **G** then press **Enter**. When you select the Cutover Port and Service Cards option, the Card Cut-Over screen is displayed, as shown in *Figure 5.7*. This screen lists the cards needing an upgrade, and the type of upgrade (hardware, firmware, or software) that is needed. The fields and user options are described on the following pages.

From the Card Cut-Over screen, you can control the card cutover by choosing the ordering and timing for the upgrade of the cards. You can select to upgrade a single card, or several cards at a time; this depends on the call handling capacity that is to be maintained on the system. Take cards out of service and, if needed, upgrade the firmware or hardware then place the card back in service. When placed back in service, the new application is downloaded onto the card (if applicable) when it is placed back in service.

You do not have to wait until a card is completely OOS before starting the cutover process on another card. The OOS and Activate options operate on a single card, not a group of cards.

If you try to take the last active card of a resource type (the only card or the last active card of a group) out of service, the system notifies you and requests confirmation prior to performing the request. Refer to *Section 5.5.15* for a list of prompts, warnings, and error messages.

```

C A R D   C U T - O V E R

R L S I   CARD TYPE                UPG      FIRM    D/L
          |                |        |    VERS  |    VERS  |   S
          |                |        |    |    |    |    |
1  1  3   Tone Generator           -F-     1.24   ----   A
1  1  4   Tone Generator           -F-     1.24   ----   S
1  1 10   Four Span T1 Card        HFS     1.12   1.49   G
1  1 14   MVDC-T1 Trunk            --S     ----   ----   O
1  1 15   MVDC-T1                  --S     1.08   1.08   A

ACTIVATE, GRACEFUL-OOS, OR FORCE-OOS (A, G, F): _ _ _

RLS 1  1 10  Being Gracefully Idled
#00  Fri Sep 11, 1998  16:55  A-USB  B-UAC

```

TP000119

Figure 5.7: Card Cut-Over Screen

The Card Cut-Over screen can display up to 14 cards. There can be up to 11 screens, which you can navigate by pressing the **Prev Screen** key if the previous screen is desired, and the **Next Screen** key to display the next screen. Use the **Exit**, **Prev Menu**, or **Main Menu** keys to exit the Card Cut-Over screen without making any changes. No changes are made unless you press the **Enter** key.

Field Definitions: Display Only

The following fields on the Card Cut-Over screen are *display only*.

RLSI — Contains the physical location of the card; rack, level, slot and interface that needs upgrading.

Card Type — Indicates the type of card in the location indicated in the corresponding column.

UPG — (Upgrade) Contains information on the type of upgrade needed on the corresponding card. The UPG indicators are:

- F Firmware update needed
- H Hardware update needed
- S Software update needed

FIRM VERS — Displays the current firmware version.

D/L VERS — Displays the current download version. If the card does not support a download, the field contains four dashes.

NOTE: The version number (FIRM VERS and D/L VERS) information is not available when the card is out of service (O).

S — Indicates the status of the card, as noted below.

A Active — ports on this card can be involved in active calls, and can be allocated to new calls.

S Standby — valid for DTG (not DTG-2) cards or redundant BRC cards.

G Graceful idling (graceful-OOS) — ports on this card are currently involved in active calls, but cannot be allocated to new calls. The card remains in this mode until all ports are idle. The card then is placed OOS.

The card remains in a status of G until the card is OOS, at which time the G status changes to a status of O.

O Out of service (OOS) — no ports on this card are currently involved in active calls, and they cannot be allocated to new calls.

Field Definitions: Data Entry

The ACTIVATE, GRACEFUL-OOS, OR FORCE-OOS (A, G, F): field is a data entry field. The options for this field are explained below.

Activate (A)

Type **A** to place the card back in service. This causes an application download upgrade on the card, if appropriate. The generic software also verifies that the version number for the firmware is compatible with the application download for the card. If not compatible, you are notified and the activation is prohibited.

Once the card is active again, it is removed from the list in the Card Cut-Over screen, and information is written to the log file to indicate that the card has been upgraded. This information is sent to the standby side via the update channel so that both sides have current information about the status of the cards.

Graceful-OOS (G)

Type **G** to take all idle ports out of service (OOS). The generic software waits for active ports to become idle before taking them out of service. Once all ports are idle, the card state is set to OOS. Until the card's status is O, indicating that the card is out of service, the card is still involved in active call processing. This command may take some time to complete, depending upon the duration of the active calls using the card.

Force-OOS (F)

Type **F** for the generic software to tear down any active calls and place the card out of service (OOS). If you select this option, you must press the **Enter** key a second time to confirm that this is what you want to do.

You can upgrade a card once the card state is OOS. You can remove cards which require firmware and/or hardware upgrades from the switch and update them after placing them in an out-of-service state. You can upgrade cards which require a software upgrade by simply activating the card.

When both sides of the system are running the new software release, you can change the configuration of the system. This may be needed to modify the setup of cards to take advantage of new features and capabilities. It is strongly recommended however, that non-upgrade related changes *not* be made until the upgrade process is complete. This helps isolate any potential problems.

NOTE: At this point, you cannot abort the operation.

5.5.13 Step 12: Back Up the New Database

Option H—Database Store (Backup)

This step involves backing up the new database. This is done in the event that there was a database conversion resulting in a changed format.

To back up the new database, from the Live Upgrade Control Menu, type **H** then press **Enter**. This option is the same as the Database Store option on the Disk Utilities menu. Refer to the System Administrator's Guide for detailed information.

You can also use the Copy Files option on the Disk Utilities menu, or FTP operations from a remote system, to store the database in an alternate location.

5.5.14 Step 13: Cleanup

Option I—Post Live Upgrade Cleanup

To initiate the cleanup, from the Live Upgrade Control Menu, type **I** then press **Enter**.

NOTE: This step is not permitted until both sides are running the new software release, and cleanup should not be performed until the card cutover has been completed.

When you select this option, the generic software removes the files from the C:/old and the C:/new directory trees.

Once you have updated both sides of your switch via live upgrade, you should now install the MIB software. Refer to *Section 4.6.1* for detailed information.

5.5.15 Prompts, Warnings, and Error Messages

This section lists the on-screen messages associated with the live upgrade feature that may appear during the live upgrade process. Refer to *Appendix D* of the *System Administrator's Guide* for system error and status messages (ALM150 to ALM157) relating to live upgrade.

Prepare for Install Messages

The following messages may appear during the Prepare for Install step of the live upgrade process.

BOOT and DBASE Files Saved

The files from the /BOOT and /DBASE directories have been copied to the temporary directories. The files are maintained there during the upgrade in case it is necessary to abort the upgrade and restore the original software.

Creating Directory Structure on Device C:

The temporary directory structure required for the upgrade is being created.

Directory Structure Created

The temporary directory structure has been created.

Installing New Software Messages

The following messages may appear during the Installing New Software step of the live upgrade process.

All Files from Floppy Copied

All files were successfully copied from the diskette.

Copying File *filename*

A specific file is being copied to the hard disk.

Copying Optional Software Failed

The installation of the optional software package failed.

File not found *filename*

The generic software expected a file to be present on the diskette during the install process. Instead, the file was not found. An abort of the upgrade will follow.

NOTE: This message may appear if there is insufficient space on the hard disk.

Installing from Generic Diskette

The files from the specified diskette are being installed.

Installing from *optional software* Diskette

The files from the optional software diskette are being installed.

Invalid Optional Software Floppy

The diskette does not represent a valid software option.

Prepare for Upgrade Messages

The following messages may appear during the Prepare for Upgrade step of the live upgrade process. An index of critical upgrade information (CUI) is generated during the Prepare for Upgrade step and recorded in the upgrade log. The critical upgrade information messages are described below.

All Files Present

The check of required files was successful.

Cannot Upgrade to Lower Version. Aborting

The administrator has installed a version of software which is earlier than the existing software. This does not represent a valid upgrade. An abort of the upgrade will follow.

Check For All Files FAILED

The check of required files failed. An abort of the upgrade process will follow.

Copied New Files

The copy of the newly installed software to the system /BOOT and /DBASE directories is complete.

Copying New Files

The newly installed software is being copied from the temporary directories into the system /BOOT and /DBASE directories.

CUI3: Critical Upgrade Information Present in Upgrade Log

One or more critical upgrade information messages appear in the upgrade log. The administrator should review these before continuing with the upgrade.

CUI#: *cardtype* at X,X,XX is the Last/Only Active Card of Resource Group

The specified card type requires upgrade, though the loss of these resources impact the groups with which they are associated.

CUI#: *cardtype* at X,X,XX, Last Resource of B Chnls of NFAS Group # for Upgrade

The specified card type requires upgrade, though the loss of these resources impact the groups with which they are associated.

CUI#: *cardtype* at X,X,XX, Limbo Card of NFAS Group # Requires Upgrade

The specified card type requires upgrade, though the loss of these resources impact the groups with which they are associated.

CUI#: Firmware Compatible, Upgrade Recommended for *cardtype* at X,X,XX

The firmware presently installed on the specified card is compatible with the newly installed software, though it is not the current version. It is recommended that the administrator upgrade the firmware during the Card Cutover step. The administrator should verify that the current version of firmware is available and that the loss of this resource during cutover will not impact service significantly.

CUI#: Firmware Incompatible, Upgrade Required for *cardtype* at X,X,XX

The firmware presently installed on the specified card is not compatible with the newly installed software. It will be necessary for the administrator to upgrade the firmware during the Card Cutover step. The administrator should verify that the current version of firmware is available and that the loss of this resource during cutover will not impact service significantly.

CUI#: NBC-3/DTG-2 at X,X,XX Upgrade Required During Update Generic Step

The NBC-3/DTG-2 upgrade(s) required cannot be done during the Card Cutover step. These cards must be upgraded during the Update Generic step of the live upgrade process.

CUI#: Redundant BRC pair does not exist, active pair requires upgrade!!

The BRC requires an upgrade and a redundant BRC pair does not exist in the database. The process of upgrading the BRC pair will result in the loss of all resources in the subrack supported by the BRC pair. The administrator should verify that the loss of this subrack during cutover will not impact service significantly.

Existing Version of *filename.tbl* is a.b.c. New Version is x.y.z.

The existing version of the specified database table is later than the newly installed version. This does not represent a valid upgrade. An abort of the upgrade will follow.

Getting Single Resource Information

The generic software is reviewing the current database configuration for information which may impact uninterrupted service provided by single resources.

Enable/Disable/Configure Optional Software Messages

The following messages may appear when in the Enable/Disable/Configure Optional Software screen.

ENTER To Confirm Disable

A confirmation prompt to verify that the software option should be disabled.

NOTE: If accessing the switch via Ethernet, disabling the Ethernet optional software will prevent you from accessing the switch after the Update Generic step.

Optional Software Configure, Complete

The configuration of software options is complete. This message is generated when the administrator exits the Enable/Disable/Configure Optional Software screen.

Optional Software Not Installed

No software options were installed. There is nothing to enable, disable, or configure.

SOFTWARE OPTION Disabled

The specified software option was disabled in the Enable/Disable/Configure Optional Software screen. This message is also printed in the upgrade log to provide a record of the configuration of the software option.

SOFTWARE OPTION Enabled

The specified software option was enabled in the Enable/Disable/Configure Optional Software screen. This message is also printed in the upgrade log to provide a record of the configuration of the software option.

Card Cut-Over Messages

The following messages may appear when in the Card Cut-Over screen.

Active DTG, Will Lose Tones! Continue?

The active DTG card is being taken out of service (OOS) as the result of a G or F command. If a standby DTG/DTG-2 is present, a DTG switchover will occur. Otherwise, the switch will be without tone generation and outpulsing during the DTG upgrade. Press the **Enter** key to continue or any other key to abort.

NOTE: This applies only to DTG cards. This does not apply to DTG-2 cards.

Card Already OOS

An attempt was made to change the status of the card to OOS when the card was already out of service (OOS).

Card Does Not Require Upgrade

A card location other than one from the list was entered. Re-enter a card location from the displayed list, in accordance with the system convention for identifying rack, level, slot, and interface.

Invalid Operation. Must be (A, G, or F)

An invalid option was entered. Valid values are A, G, or F.

Last Active Card of ResGrp #! Continue?

The last card of the specified resource group is being taken out of service (OOS) as the result of a G or F command. Press the **Enter** key to continue or any other key to abort.

Last B chnls of NFAS Grp #!, Continue?

The last B-channels of the specified group is being taken out of service (OOS) as the result of a G or F command. Press the **Enter** key to continue or any other key to abort.

Limbo Card of NFAS Group #!, Continue?

The last card of the specified group is being taken out of service (OOS) as the result of a G or F command. Press the **Enter** key to continue or any other key to abort.

NBC-3/DTG-2 Cutover Not Allowed

An NBC-3/DTG-2 card was selected for cutover. The NBC-3/DTG-2 card upgrade must be performed during the Update Generic step.

No Cards Require Cutover

The Card Cutover screen was selected, however no cards require cutover.

Not Allowed!! Card Gracefully Idling

An attempt was made to change the status of the card to OOS when the card was gracefully idling.

RLSI X,X,XX Being Forced OOS

The F command to force the card OOS was entered. The system forces the card specified by the rack, level, slot and interface, out of service (OOS).

RLSI X,X,XX Being Gracefully Idled

The G command to gracefully idle the card was entered. The system gracefully takes the card specified by the rack, level, slot and interface, out of service (OOS).

RLSI X,X,XX Is Now Active

The card indicated by rack, level, slot and interface has become active.

RLSI X,X,XX Is Now OOS

The card, indicated by rack, level, slot and interface has become out of service (OOS).

Taking Active BRC OOS, Continue?

This warns you that a BRC card taken out of service (OOS) will cause a BRC switchover. Press the **Enter** key to continue or any other key to abort.

General Live Upgrade Messages

The following general messages may appear during the live upgrade process.

Invalid Option

An invalid option was selected from the Live Upgrade Control Menu.

Live Upgrade Aborted...

The abort sequence has completed.

Live Upgrade Aborting...

The live upgrade process has initiated an abort sequence. The abort sequence is initiated by you or initiated automatically when a configuration issue has been identified.

Operation Not Allowed During Upgrade,

The requested operation cannot be performed while the switch is undergoing a live upgrade.

Resetting System ...

The switch has prepared itself for the reset of the standby controller and the reboot will follow shortly.

Restored Original C:/BOOT and C:/DBASE files

The original /BOOT and /DBASE files have been restored from the temporary directories as part of the abort sequence.

Switchover Not Allowed During Upgrade, (Maintenance menu switchover)

A manual switchover had been requested from the Maintenance menu during a live upgrade. This is not allowed during the live upgrade process.

Waiting for Stable State

The switch is preparing itself for a reset of the standby controller. Upon reboot of this controller, the newly installed generic software will be running.

Section 6

KNOWN DESIGN CONSTRAINTS

Summa Four has identified the following design constraints in Generic V5.0, V5.1, and related software.

U803300005: Field Limitation for Inpulse/Outpulse Rules

The Programmable Trunk Configuration (non ICC or 4xT1/E1), Diagnostics Port Display, Call Progress tone monitor, and Routing Statistics Display screens support only two digits for inpulse rules. In a future release, all appropriate fields will be increased to three digits to support the increased inpulse rule system limits.

Drop and Insert Card Not Supported in C-bus Mode

Generic V5.0 FSR00 and V5.1 FSR00 do not support the Drop and Insert (D+I) card in C-bus mode. The D+I card can be used in 2K mode.

SNMP Walk Freezes

When an SNMP walk is performed on the entire MIB, the walk may freeze but does not appear to affect other switch processing.

MVDC T1 Not Supported in C-bus Mode

The current MVDC T1 firmware does not support card operation in C-bus mode. A firmware upgrade is required for C-bus support. The current firmware will, however, support operation in a 2K system.

ICC Requires Reboot After Download

After a download to the ICC card, the card will reset itself in order for the new download to take effect.

Section 7

KNOWN FUNCTIONAL CONSTRAINTS

Summa Four has identified and evaluated functional constraints in Generic V5.0 and V5.1 software, firmware, and hardware.

7.1 INTRODUCTION

This section provides explanations and, where applicable, workarounds for functional constraints in the areas that follow:

- System Administration
- System Configuration Utilities
- Special Redundant Systems Considerations
- Disk Operations
- Digit Collection
- Inpulse/Outpulse Rule Processing
- Call Processing
- Command/Report Processing
- Initialization
- Digital Tone Generator (DTG) and Digital Tone Generator-2 (DTG-2)
- Four Span Cards
- Interface Controller Card (ICC)
- Miscellaneous Card Issues
- Multiple Host Connections
- TeleRouter
- Service Platform Card (SPC)
- Simple Network Management Protocol (SNMP)
- ASIST API Programming Reference
- Ethernet
- ISDN Issues
- International Issues

7.2 SYSTEM ADMINISTRATION

The constraints described in this subsection apply to system administration tasks performed from the System Administration console.

NOTE: Not all system administration tasks are supported by SNMP. See Section 7.18 for a list of the tasks not supported.

Database Conversion Error Reported

A DB CONVERT ERROR message is generated when you perform an incremental install and then do a database conversion. This occurs when upgrading from V4.0 or V4.1 to V5.0.

U507315162/TR 5162: No Automatic Database Conversion

You may experience a problem if you inadvertently try to load a backup copy of an outdated database. The system does not detect the outdated database and does not automatically perform the database conversion.

U508295234/TR 5234: Adding Cards to End of Configured Database

If you try to add cards to the end of a configured database, you may see the following message: NO AVAILABLE PORT MEMORY. This is caused by port fragmentation, which means that there are enough total ports, but they are not contiguous.

This could happen, for example, if 1576 ports are assigned out of the 1776 that were licensed, and you try to add a 64-port IPRC.

Resolution

Rebuild the database to reallocate the ports in a contiguous block.

U512071001: Aux1 Alarm Not Set on System Alarms Display Screen

Aux1 alarms triggered by the hardware (i.e., power supply, fan unit, or ring voltage failure) are not displayed on the System Alarms Display screen. Therefore, remote users cannot determine if a major hardware alarm is set.

U604041001: IPRC Voice Prompt Maintenance

The following error message can occur when you add voice prompts for the IPRC card in the Voice Prompt Maintenance screen:

ERROR — Cannot Add Prompt Err = 780

You might have entered a bad directory path, or the file might not be in the location specified.

Resolution

Verify that you have specified the correct directory and path name.

U605010004: Keyboard Type is Reset During System Reboots

The administration console intermittently gets re-initialized when the system reboots. This causes the keypad to reset to Numeric, instead of Application, which is required by the Generic.

Resolution

To correct this condition on systems with VT220 consoles, complete the following steps:

1. From the login screen, press **PF3**. The Set-Up Directory menu appears.
2. Use the arrow keys to position the cursor in the General field and press **ENTER**. The General Set-Up Menu appears.
3. Use the arrow keys to position the cursor in the Keypad=Numeric field and press **ENTER**. The field toggles to Keypad=Application.
4. Press **PF3** to save the setting and return to the login screen.

To correct this condition on systems with WYSE consoles, complete the following steps:

1. From the login screen, press **PF3**. The Set-Up Directory menu appears.
2. Press **PF11** (Kbd2). The Keyboard2 Set-Up Menu appears with the cursor in the Keypad=Numeric field.
3. Press **ENTER**. The field toggles to Keypad=Application.
4. Press **PF4** to save the setting and return to the login screen.

U611260002: Abort Button

Pressing the ABORT button on the system controller has no effect if the Ethernet option has not been installed.

U704100002: No Error Logged Upon Failure

No error indication is logged when the switch fails. Earlier versions logged an error indication to aid in determining the cause of failure.

U705050001: FTP Quote Command Inconsistent

The quote compress command requires a drive specification (c:), but the uncompress and the split commands can't accept it.

U705050002: FTP Quote Join Command Error

The FTP command: quote join c:core1 c:core1.x?? does not work. The command results in the error: 500, Command not understood.

U802020002: Large Trace Files Can Not Be Deleted

When attempting to delete large trace files, an Error During Disk Operation message may appear.

Resolution

Do not create a large trace file.

U802060004: Prompt Library Not Working Properly

When the prompts are loaded, the library menu lists the prompts and the duration of each, but the total usage field displays an invalid sum of the prompt times. The IPRC behaves normally, and no other effects are noticed in the system.

7.3 SYSTEM CONFIGURATION UTILITIES

The constraints described in this subsection apply to system configuration changes performed through the System Administration console.

U411304788/TR 4788: Viewing Software Configuration on Floppy Disks

Avoid using the Software/Firmware Configuration screen to view the contents of floppy diskettes (device A:). This screen does not produce consistent information.

Resolution

To view the contents of a floppy diskette, use the Disk Utilities Show Directory function.

7.4 SPECIAL REDUNDANT SYSTEMS CONSIDERATIONS

The constraints described in this subsection apply to redundant systems only.

U606190001: System Host Configuration Update Problem

On redundant systems, when you change the System Host configuration, you may get the error, RED44: Standby DB Update Error - Bad Record Count, File [filename]. When this error occurs, the changes made on the Active side do not get written to the Standby side.

U701290006: DVC \$9 Timeout on Transfer to Standby

When you insert a DVC, it intermittently fails the download. A \$9 timeout message is generated and also an FRM006 Transition From Standby To Active message. The system, however, does NOT change from Standby to Active.

Resolution

Reinsert the card or activate the card from the Card Maintenance screen.

U801300003: Mismatched Timeslot Allocation Numbers

On a redundant system, the active and standby sides may not correctly reflect the license of the opposite side, i.e., the numbers match but the active side reports a lower number of timeslots being allocated on the active side than on the standby side.

Resolution

Set the license on both sides from the install diskettes.

U808200004: Update Channel Failure

When SPC-CONF interfaces are removed from a resource group, the standby side fails with the following messages:

FRM340: CODE Error - serv_resgrp.cc,334: FATAL, group 63

FRM500: N/A Event Set For - ALM084: UPD Receive Time (NSA)

FRM503: Minor Alarm Set For - ALM080: Update Channel Failure (NSA)

After messages have been generated, the system file synchronizes and continues from the point of failure.

7.5 DISK OPERATIONS

The constraints described in this subsection apply to actions involving the Disk Utilities.

U409224673/TR 4673: Database Utility Covers File Access Errors

If an error occurs in the disk operation when you use the Data Base Store or Data Base Retrieve commands (under File Utilities), no warning is displayed to indicate that all files may not have been copied correctly.

U505035026/TR 5026: Formatting a Floppy During Reboot

Attempting to format a floppy diskette while the system is downloading a card causes the system to reboot with the error, FRM506: Fatal Processing Error Due To - ALM002: Network Manager Failure (SA).

Resolution

Do not use the Disk Utilities function to format a floppy diskette.

U604121001: Mismatch Between On-line and Diskette Disk Utilities

Files that are created with the diskette disk utilities and which have special characters in them, such as underscores, are not readable with the on-line generic disk utilities when the system is up and running.

U801170001: System Crashes When Reading Incorrectly Labeled Floppy Disk

The disk format screen allows you to enter invalid characters in the label field. Doing so causes the controller to crash when you attempt to read the incorrectly labeled disk. Floppy disks formatted successfully on the switch may subsequently produce an error when a directory is attempted or may cause a core dump and system reboot when a read is attempted.

This occurs only when the floppy is formatted with a volume label containing an illegal character is included in the file name. Illegal characters include `*?/\ | ,;:+=[]{}&^<>`.

Resolution

The Format Disk function, located within Disk Utilities, has been disabled. When you attempt to format a floppy diskette in the A: drive, the following message appears:
Formatting A drive is Not Permitted.

7.6 DIGIT COLLECTION

The constraints described in this subsection apply to DTMF/MF digit collection. The type of collection (DTMF or MF) is specified where necessary.

TR 2274: Single Digit Collections (8-Port DTMF Cards Only)

Using single digit end flags while performing DTMF digit collection may result in misplaced or unreported digits. The receiver requires processing time to detect a digit string, report the string to the generic software, and then reset itself for another collection. Collecting single digits as start/end designators between larger strings can result in missed digits because the DTMF receiver does not have sufficient time to reset before the next digit is entered. This situation can be aggravated when the digit timing does not match the optimum timing of 60ms of tone followed by 60ms of quiet. DRC 24/48 port cards function properly.

Resolution

Collect and store incoming DTMF digits as a single digit string. Digit fields 1 through 4 can store up to 40 digits; the ANI field can store up to 20 digits. Digit strings are reported to the host in either a DTMF Digit (\$D1) report or as a segment in an Inpulse Rule Complete (\$DD) report. Using these reports, the host application can parse digit strings into their functional groups, as required.

U507315157/TR 5157: Garbled MF Digit Reports Not Sent to Host

MF Digit (\$D0) reports indicating garbled digits are not sent to the host when the impulse rule performing the collection contains the reporting control tokens REP EACH or REP NEXT. The system sends an Impulse Rule Complete (\$DD) report informing the host that the impulse rule was aborted, but does not send a subsequent \$D0 report. All other conditions that cause an impulse rule to abort generate an additional report explaining the cause. If you use the reporting control token REP END in the impulse rule, the \$DD report correctly contains a \$D0 segment indicating that the MF digits are garbled.

If an impulse rule with a REP EACH or REP NEXT token aborts while performing MF digit collection without generating an additional report, assume that the digit collection is garbled.

7.7 INPULSE/OUTPUTSE RULE PROCESSING

The constraints described in this subsection apply to values for impulse rule tokens.

U503234961/TR 4961: RELEASE Impulse Rule Requires Resource Type

You must specify a resource type when you use the impulse rule token RELEASE. If you do not specify a resource (IPRC, MRC, DRC, DTG, or CPA), the RELEASE token has no effect.

U608140005: RELEASE DTG Token Does Not Work

The RELEASE outpulse rule token does not release the DTG/DTG-2 and causes the system to log an error during impulse rule execution.

U806250001: Impulse Rules Aborting on Port \$47F

All impulse rules are aborting on port \$47F when using an ICC-T1 and a 1xT1. This does not, however, occur with a DTG card.

7.8 CALL PROCESSING

The constraints described in this subsection apply to call processing.

U407064606/TR 4606: DASS Ports Stuck in MAINT-NE State

DASS ports may become stuck in a MAINT_NE state.

Resolution

Clear a port by deactivating it and then activating it with the Port control function of the Card Maintenance submenu. Or, take the card out of service and then reactivate it.

U410264726/TR 4726: After Switchover, SLIC OGT Keeps Ringing

If a SLIC ICT (Incoming Trunk) is telerouted to SLIC OGT (Outgoing Trunk), and the SLIC OGT is ringing during a switchover, the SLIC OGT does not stop ringing when the SLIC ICT goes back on hook.

U503284968/TR 4968: Disconnect Fails Unless Port Goes Through Stable

A voice path must be established between incoming and outgoing ports (both ports are CP_STAB) in order for those ports to successfully disconnect.

U505085035/TR 5035: Multiple Host and High Load Causes System Failure

Using an Ethernet system /Host interface with up to four hosts and high loads may cause the system to fail. Higher loads may support even fewer host connections.

U505115041/TR 5041: Interval Between Seizure and Wink

One of the fields in Trunk Timing configuration is the Wink Send. For E1, this is the time period of the delayed dial signal. Tests have shown that this is about 60ms as opposed to the 30ms stated in the specifications.

7.9 COMMAND/REPORT PROCESSING

The constraints described in this subsection apply to all host-issued commands and received reports.

U507315159/TR 5159: Appending Digits via the \$67 Command

When appending an odd number of digits to a field, which already contains an odd number of digits, the last digit of the first string and the first digit of the last string are lost. Two zeros are added to the end of the string to provide the correct number of digits.

Resolution

To avoid this condition, use two digit fields for digit storage instead of appending digits to an existing field.

U507315160/TR 5160: Number of Digits to Collect (\$67 Command)

You can use the \$67 command to collect up to 40 digits. Specify the number of digits that you want to collect in the Digit Collection Control (byte offset 9) byte. Command processing does not currently check this value to verify that the number is less than 40. If you specify a number greater than 40, the system still attempts to collect only 40 digits. The command is not rejected with a Network Status byte value of \$2C, as would be expected.

Resolution

Specify 40 or less in the Digit Collection Control byte.

U507315161/TR 5161: Inpulse Rule Complete (\$DD) Report Processing

A \$DD generated when an inpulse rule aborts due to a CPA exhaust condition, does not correctly specify the cause for the abort. The report indicates that the rule aborted because no outpulse channels were available (T = 1 in the Inpulse Rule/DVC Port byte offset 10). However, the CPA exhaust condition is identified by a Resource Allocation (\$D6) report, which specifies a resource limitation for the CPA resource group.

U508175187/TR 5187: \$67 Command and Inpulse Rule—Digit Collection

When the caller enters digits, it appears that a combination of the \$67 command and inpulse rule is being processed. The digits that are reported are the first three digits that the caller input. Those digits are reported in a \$DD report and are also stored in field 1.

A second collection command (via the inpulse rule specified in the \$6A command) does not completely override the first collection command (in the \$67 command). The DRC collects only 3 digits and reports them to the host, per the \$67 command, but then stores those digits in field 1 per the inpulse rule.

Resolution

Have the application remove the receiver attached with the \$67 command when the outgoing hangs up. Then send the \$6C, and then the \$6A to start the inpulse rule.

U603210001: NSB \$02 Returned for \$65 and \$49 Commands

A Network Status Byte of \$02 (Invalid command function ID) is returned by the Subrate Path Control (\$65) command when the \$65 command contains 82 destinations. The ISDN Port Control (\$49) command also returns a Network Status Byte of 02 if the \$49 command contains between 258 and 261 bytes.

U803150002: NSB \$23 Returned for \$65

A Network Status Byte of \$23 (Illegal address error) is returned by the Subrate Path Control (\$65) Command when the \$65 command contains an address greater than 0x7ff. This occurred when the Subrate Card (SSC) was active and C-bus was enabled. Several spans of an ICC-E1 card were then added. The spans were located at address 0x900 and above. When a \$65 command was sent to connect a subrate path through the spans the switch returned NSB = 23.

U808280002: \$83 Report is Incorrect In Extended Mode

The “C” bit in the last fragment of the \$83 report is reporting digits rather than a 0 (zero). This bit should report a zero indicating this is the last fragment.

U809210002: \$DD Rule Status Byte Not Initialized in Extended Mode

In extended mode processing, the rule status byte in the cp_sreport.c is not initialized or set. Therefore, if anything is in memory at that location prior to the report being built, the data will appear in the report.

7.10 INITIALIZATION

The constraints described in this subsection apply to system initialization.

U311104202/TR 4202: System Sends \$DC Report too Early

After a warm start, the system sends a (\$DC) report to start call processing before IPRC prompt downloading is complete.

Resolution

You can use the feature flag and not start call processing until the system receives a command from the host (\$C0 04) to send that command when the IPRC changes from Maintenance to Active.

7.11 DTG AND DTG-2

The constraints described in this subsection apply to the DTG and DTG-2 card.

U610020003: DTG/DTG-2 Add/Delete During Outputting

If you add or delete a tone generator card while another tone generator is outputting, the switch may be unable to do further outputting and may even fail.

Resolution

Do not add or delete tone generator cards while the switch is processing calls.

U703120001: Deleting a DTG from the Database Stops Outputting

If you delete a DTG from the database in an active system, outputting ceases. This occurs even when there is no DTG physically present but there is a working DTG-2 available.

Resolution

A system reboot, or a system switchover to the other side, restores normal operation of the DTG-2. A switch back (after the switchover) to the first side will continue to operate normally.

7.12 FOUR SPAN CARDS

The constraints described in this subsection apply to the MVDC T1 and Four Span T1/E1 cards.

U507185123 (formerly U507201007): Processing WINK Command

When the Four Span T1 is configured as FX0-LX, the card processes a WINK command after it seizes out.

Resolution

Do not use a WINK in an outpulse rule when Four Span T1 cards are configured as FX0-LS.

U603151001: Inconsistent Handling of Channels on Four Span E1

With Four Span E1 cards, resource groups can include channel 17, depending on whether the card spans are provisioned for CCS/31B or CAS. In CCS/31B mode, channel 17 is a bearer channel and can be added to a resource group. In CAS mode, channel 17 is used as the D-channel, and therefore, cannot be in a resource group.

After a Four Span E1 card is added and configured, you can change the mode from the Resource Group Configuration screen. However, the system does not automatically remove channel 17 from the resource group when the mode is changed from CCS/31B to CAS, or automatically add channel 17 to the resource group when the mode is changed from CAS to CCS/31B. When the span is changed from CCS/31B to CAS, all call attempts on channel 17 fail, because channel 17 is no longer a bearer channel. When a span is changed from CAS to CCS/31B mode, bandwidth is wasted.

Resolution

Verify that resource groups properly reflect the nature of channel 17 when changing the mode of a Four Span E 1 card span between CCS and CAS.

NOTE: The System Administration console and SNMP do not prevent users from configuring bearer-channel signaling and timing parameters for channels that are not truly bearer channels. This applies to channel 17 for CAS mode and channel 1 for both modes. (Channel 1 is used for framing.) Users may find this misleading, but it is harmless.

U604260001: Testing Patterns from TTS-3 Analyzer Causes Errors

MVDC T1 and Four Span T1/E1 cards perceive the test patterns from a TTS-3 Analyzer as incoming seizures and generate FRM373 (Internal Message Length Error) and FRM102 (Card MSG) errors.

Resolution

Remove the test boxes before connecting the system to the network and processing calls.

U606101001: MVDC T1s/Four Span T1s Generate FRM90 Before Download

Multiple iterations of the FRM090 message (Card restored, card alarm cleared) are generated while MVDC T1 and Four Span T1 cards are downloading, coming into service, and going active.

U606241001: Four Span T1/E1 Internal Errors During Boot

During the broadcast download cycle, Four Span T1 and Four Span E1 cards intermittently generate an internal error code 1. The broadcast download fails, but the system recovers and successfully performs a direct download to each card.

Resolution

None. This issue does not affect service.

U611140005: Four Span T1 on Switchover Not Performing Correctly

If you change the mode on a Four Span T1 card from active to maintenance, and then to out of service, from the Active side of the system, the changes also occur on the Standby side. However, if you change the mode back to active from the Active side, the card stays in maintenance mode on the Standby side. If the switch changes over while this condition exists, calls are lost.

Resolution

From the Active side of the switch, change the mode back to out of service, to active, to maintenance, and then back to active. This causes the Standby side to change from maintenance to active mode.

U611250003: FRM523 Queue Overflow

The messages FRM523 Queue Overflow, Data Lost and Data lost on Screen_Msg Queue may appear when the system broadcasts a download to a large number (14 or more) of MVDC T1 cards.

U611260001: Rotary Resource Group

If the outgoing Four Span T1 trunk resource groups are set to ROTARY search, the ports in the resource group get stuck in CP_WTFSUP.

Resolution

Use CYCLIC search.

U704140004: Display ACTIVE while Downloading

Following a warm reset, the 4xE1 cards display ACTIVE while downloading.

U710290005: MVDC T1 Fails to Clear Alarms

When multiple MVDC T1 cards are installed in a subrack, some cards re-download after a warm restart. The cards finally clear alarms after the download is complete. Also, there are queue overflows with data lost on RED_TX_Q, SCR_MSG_Q, CP_TX_Q, and SNMP_MSG_Q.

U710300008: Aborted Download Does Not Resume After Switchover

In a redundant system, when a download is in progress and an Active to Standby switchover occurs, the MVDC T1 download aborts on the previously Active side but does not resume on the new Active side.

U710310001: Display Card Data Screen Not Recording Slips

The Display Card Data screen does not record slips. The system was forced to slip by changing the AM2-D bulk call generator from internal to LINE A. Slips are recorded at the load box but the slip count does not increase on the Display Card Data screen.

7.13 INTERFACE CONTROLLER CARD (ICC)

U803040001/802260013: ICC E1 Spans Reporting FRM113

The ICC E1 card, with Flash 2.2, is reporting FRM113 remote alarms in the log files even when the ICC E1 spans are not connected to a carrier. In some cases, ports which were previously IDLE go into a CP_MBUSY DIAG_OEND state following either a switchover from the AAC or reseating an ICC.

U803150001: Blue Alarms Received on ICC E1

When both the ICC E1 and Subrate Card (SSC) are set to CCS/31, the ICC E1 receives FRM123: T1/E1 BLUE ALARM DETECTED messages. This message should only appear when the span is out of service and not ready to receive calls.

U808270002: ICC-E1 and D+I Does Not Work When Set For Mu-law

The ICC-E1 does not work with the D+I card when the backplane law (System Features screen) and all ICC-E1 ports (ICC Programmable Trunk Configuration screen) are set to Mu-law.

U808270003: ICC-T1 Clear Channel Does Not Work

The ICC-T1 does not work with the D+I card when, while configuring the ICC Programmable Trunk Configuration screen, the Span Type field is set to SF and the Signaling Type of the port is set to Clear.

Resolution

Set the Span Type field to SF_NR.

7.14 SERVICE PLATFORM CARD (SPC)

U809240004: SPC Without SRM Installed Displays in Maintenance Mode

If a DSP SRM is not physically installed on the SPC, but the DSPs are configured in the database, the system displays the SPC with a status of Maintenance (M) rather than Out of Service (O).

U804300003: SPC Fails Multi-field DTMF Collection

The SPC may fail multi-field DTMF collection.

U806230005: SPC Goes OOS When Running a DTMF T1/E1 Load

The SPC goes out of service (OOS) when running a DTMF T1/E1 load. An FRM101: CARD OOS - RLS x x xx-x-x (CARD ALARM SET) message is reported to the log file. No calls can be processed after this error is generated. All DTMF collection ceases even after the SPC becomes Active again.

U806300002: SPC-CPA Sensitive to DTMF Digits

The SPC-CPA (V4.07) may report DTMF digits as voice detect.

U806300007: Error Opening Specs File

The following error message may appear when activating the SPC, DWNLD Error opening specs file (filename). This error is expected and should not indicate any unusual error condition.

U806300008: Tone Tests Failure

The SPC-CPA card fails the Busy (4D1) and Reorder (4D2) tone tests. Also, during diagnostics testing, some ports mistake a Busy or Reorder tone for Voice.

U806300009: SPC-DTMF Fails Multi-field Collection

The SPC-DTMF fails to collect all digits in a multi-field collection: Digit collection ceases after the first field.

7.15 MISCELLANEOUS CARD ISSUES

The constraints described in this subsection are miscellaneous card issues.

U409124662/TR 4662: UTC Firmware Causing T1 INIT Code F Error

The UTC firmware does not initialize the serial port in order to disable it. This might cause T1 INIT CODE F errors. Summa Four recommends that all firmware be checked to make sure that the serial port is disabled.

U505105038/TR 5038: Reorder Tone is Not Reported/Detected (UK)

The Call Progress Analyzer (CPA) in use in the UK does not detect the Reorder Tone from the Dial Tone Generator (DTG).

U603021003: IPRC Load Problems with More than 22 Seizures

Load seize on impulse rules with record and speak tokens at 22 seizures cause IPRC cards to go OOS. If simultaneous seizures occur while the IPRC is recording and playing temporary prompts, on systems configured with MFCR2 and Four Span E1 cards, which use Channel Associated Signaling (CAS) with CRC4 set to ON, the IPRC card goes out of service and causes the system to fail.

The IPRC also goes out of service and causes the system to dump and reboot when an impulse rule, used to collect DTMF or MFCR2 digits, is followed by an impulse rule, used to record a prompt with the GOTO RULE or DO IRULE token.

U609230005: Outgoing T1 Stuck in CP_OUTPUL

Outgoing ports on Single Span T1 cards intermittently become stuck in CP_OUTPUL after incoming seizures.

U808040004: SSC Downloads and Goes Into Maintenance State

On cold or warm starts, the Subrate Switching Card (SSC) downloads then goes into maintenance (M) state.

Resolution

Take the card out of service (OOS), then bring it to an active (A) state.

U809080001: SSC Shows Incorrect Port Address

When you first add an SSC to the database, the Card Summary screen shows a port address of zero. The card downloads, but rather than the card going active (A) , it goes into maintenance (M) state. If you take the card out of service (OOS) then bring it to an active state, the following message may appear: Download is in Progress.

Resolution

To display the correct port address for the SSC, and have the card go into an active state, you must reboot the system.

7.16 MULTIPLE HOST CONNECTIONS

The constraints described in this subsection apply to SDS/VCO systems connected to multiple hosts.

U605091001: Major Alarm Not Set on Loss of Hosts

The system does not generate the following alarm when all external host connections are lost and TeleRouter has been enabled:

ALM011: No Hosts Available

If TeleRouter is disabled after being enabled, the alarm is still not generated unless a new Ethernet host is configured and all host connections are then lost.

7.17 TELEROUTER

The constraints described in this subsection apply to systems with the Telerouter option.

U606041001: TeleRouter \$D5 (Routing Action) Reports

Telerouter \$D5 (Routing Action) Reports do not appear in the system trace file, but they are sent to the host.

7.18 SIMPLE NETWORK MANAGEMENT PROTOCOL (SNMP)

The constraints described in this subsection apply to SNMP operation.

Functions Not Supported

NOTE: There is no SNMP support for Network Side NET5, the REORDER tone feature for Japanese networks, or for other V5.0 features.

The Management Information Base (MIB) does not support the functions on the following System Administration screens.

- Disk Utilities Menu
- Print/Display System Log File Submenu
- Print/Display System Trace File Submenu
- Set Up Path Submenu
- Conference Display Screen
- Service Circuit Test Utility Screen
- Test Port Card Screen
- Call Generation Ports Display Screen
- Call Progress Tone Monitor Screen
- System Trace Configuration Screen

In addition, the MIB does not support the Routing Statistics Display function on the TeleRouter screen.

U608130005: SNMP Resource Group Configuration Problem

If you use SNMP to configure resource groups on redundant systems, the port.tbl file gets corrupted and ports are missing from resource group.

U708140005: D+I Card Not Supported Via SNMP

Configuration of the Drop and Insert card can only be done via the system administration master console. SNMP support for this card will be added in a future release.

7.19 ETHERNET

The constraints described in this subsection apply to Ethernet.

U608080006: Problem with Ethernet Install

If you attempt to update the gateway routing tables before Ethernet is installed and enabled, the gateway routing tables get corrupted.

Resolution:

Install and enable Ethernet before you attempt to update the routing tables.

7.20 ISDN ISSUES

The constraints described in this subsection apply to PRI and PRI/N ISDN configurations.

U401054297/TR 4297: ISDN Ports Remain in DISC_REQ State

If phantom-to-DASS port calls are set up and torn down periodically for all the ports on a card, the DASS ports may become stuck in a CP_GARD, NORMAL, DISC_REQ state. If this happens to only a few ports on a card (some ports remain idle), incoming call attempts from the PSTN fail and no indication of the call is received. Outgoing calls from the SLIC connect but the DASS ports remain in a CP_WTSUP, O_INITED state.

7.21 INTERNATIONAL ISSUES

The constraints described in this subsection apply to international issues.

U505125048/TR 5048 Chile CPA Does Not Detect Tones

The Chile Call Progress Analyzer (CPA 8.51) used with the Dial Tone Generator (DTG 1.02) does not detect DIAL, BUSY, RING, and CONGESTION tones, and reports CPA Internal Errors (Code 44).

U505155052/TR 5052: Finland CPA Does Not Detect Tones

The Finland Feature Package (CPA 8.70 with DTG FW V1.00) does not detect tones. All tones are detected as Voice Detect and Voice Cessation.

U505255069/TR 5069/TR 5068: Colombia CPA Intermittent Tone Detection

The Colombia CPA (V19.02) detects the SIT (04D4) tone intermittently. SIT tone is detected as PAGER CUE, VOICE, and VOICE CESSATION tones. RING tone is detected only 60% of the time; REORDER tone 40% of the time. SPECIAL REORDER tone is not detected at all.

U508075168/TR 5168: Multiple MFCR2 Cards with Colombia V19.02

When you add more than one MFCR2 board to a system running Colombia V19.02, some of the calls might fail to seize ports. Occasionally, the boards fail and need to be reset before they start working again.

Appendix A

REPLACING PROMS AND PLDS

A.1 INTRODUCTION

This appendix describes the procedures for installing new firmware and programmable logic in circuit cards. Firmware is shipped in the form of programmable read only memory (PROMs), dual in-line packages (DIPs), integrated circuits (ICs) for through-hole mounting, and plastic leaded chip carriers (PLCC) for surface mount.

Programmable logic is shipped in the form of programmable logic devices (PLDs), DIPs for through-hole mounting, and PLCCs for surface mount.

PROMs are labeled with configuration data which should be checked, prior to installation, against the firmware requirements contained in *Section 3*. PLDs are labeled with their LP identification number.

A.2 REMOVING and REPLACING THROUGH-HOLE PROMS and PLDS

The following sections provide information about removing and replacing through-hole PROMs and PLDs. Refer to the appropriate technical description for the physical locations of the PROMs and PLDs on each circuit card.

A.2.1 Removing Through-hole PROMs and PLDs

1. If the circuit card is currently installed in the switch, follow the removal and replacement procedures in the appropriate technical description. Be sure to also locate affected circuit cards kept as spares.

CAUTION: Observe antistatic precautions near circuit cards. Wear a ground strap connected to the equipment frame whenever servicing or cleaning circuit cards. The ground point is located above the card slots on the front of the switch, and is indicated by the "Connect ESD Wrist Strap Here" label.

2. Remove the PROM to be replaced from the circuit card. Use a PROM removal tool to grasp the integrated circuit and pull it straight up and away from the socket.

CAUTION: To prevent damaging PROM pins or scratching the circuit card, avoid using devices such as screwdrivers to remove PROMs.

3. Remove the new PROM chip from the shipping package. Refer to *Section 3* to verify that the label on the chip matches the software requirements.

A.2.2 Replacing Through-Hole PROMs and PLDs

1. Before installing the new chip, verify that its pins are all evenly spaced and vertically aligned. If necessary, align the IC pins properly prior to installation. To align the pins, you can either use a commercially available pin-straightener tool, sized for a 28-pin DIP device, or you can lay the PROM or PLD on its side and gently press the top edge, as shown in *Figure A.1*, being careful not to press on the pins. Repeat this procedure for the other row of pins.

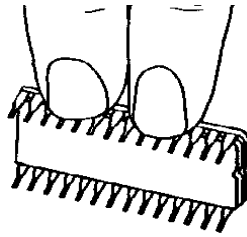

Figure A.1: Aligning PROM or PLD Pins

2. Orient the PROM or PLD chip so that the notch in the chip, shown in *Figure A.2*, faces the notch on the circuit card.

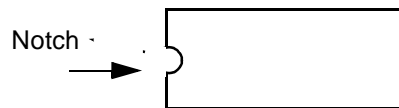

Figure A.2: Notch Orientation for IC

3. Carefully insert the pins on one side of the PROM or PLD chip into holes on the correct side of the socket, as shown in *Figure A.3*.

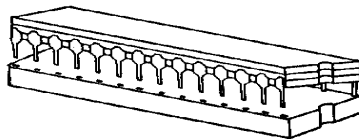

Figure A.3: Inserting Pins on One Side of Socket

4. Insert the pins on the other side of the PROM or PLD chip into the remaining holes of the socket, as shown in *Figure A.4*.

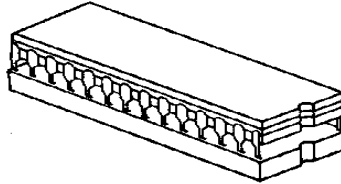

Figure A.4: Inserting Pins on Other Side of Socket

NOTE: If the pins are not aligned with the socket holes, remove the PROM or PLD chip and straighten the pins, as described in Step 1. After realigning the pins, repeat Step 2 through Step 4.

5. Carefully examine all the pins on the PROM or PLD chip. Be sure that none of the pins are bent or touching one another.
6. With all of the pins inserted into the socket holes, apply gentle and even pressure to the top of the chip until it is fully seated in the socket.
7. Re-install the circuit card in the system or return the card to spares stock.

A.3 REMOVING AND REPLACING SURFACE-MOUNT PROMs and PLDs

This section provides information about removing and replacing surface-mount PROMs and PLDs. Refer to the appropriate technical description for the physical locations of the PROMs and PLDs on each circuit card.

CAUTION: To prevent damage to the board, make sure you use the proper tool to remove surface mount PROMs and PLDs.

A.3.1 Removing Surface-Mount PROMs and PLDs

1. If the circuit card is currently installed in the system, follow the removal and replacement procedures contained in the appropriate technical description. Be sure to also locate affected circuit cards kept as spares.

CAUTION: Observe antistatic precautions near circuit cards. Wear a ground strap connected to the equipment frame whenever servicing or cleaning circuit cards. The ground point is located above the card slots on the front of the switch, and is indicated by the "Connect ESD Wrist Strap Here" label.

2. Use the surface-mount chip removal tool, provided by Summa Four, Inc., to remove the PROM or PLD that is to be replaced on the circuit card. To remove the PROM or PLD chip:
 - a. Spread or compress the tool legs so the tongs fit into the slots of the chip carrier socket.

- b. Insert the tool tongs into the slots of the socket, and push firmly so that the tool butts on the socket.
 - c. Place the thumb and forefinger on the tool's grip. Squeeze the thumb and forefinger together to remove the chip from the socket.
3. Remove the new PROM or PLD chip from the shipping package. Refer to *Section 3* to verify that the label on the chip matches the software requirements.

A.3.2 Replacing Surface-Mount PROMs and PLDs

1. Before installing the new PROM or PLD, verify that the pins are all evenly spaced and properly aligned. If necessary, use tweezers to carefully align the IC pins prior to installation.
2. Align the notched edge on the PROM/PLD to the silkscreened dot on the circuit card, as shown in *Figure A.4*.

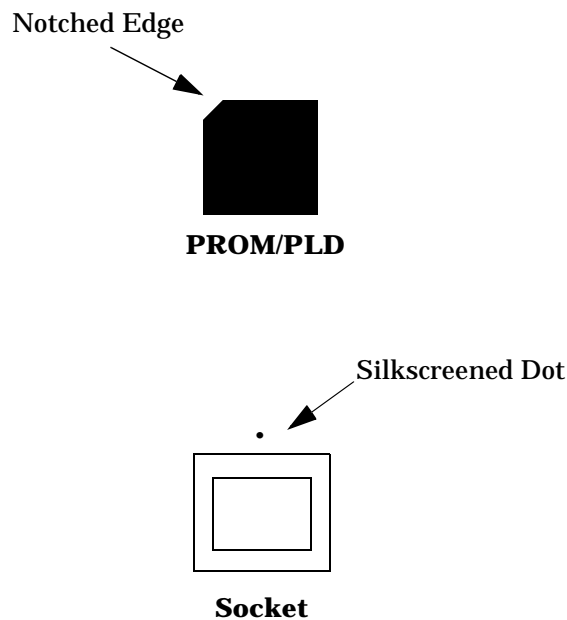

Figure A.4: PROM/PLD Alignment

3. With all pins aligned to the pins of the socket, apply gentle, even finger pressure to the top of the chip until it is fully seated in its socket. This completes the installation of the surface mount chip.
4. Reinstall the circuit card in the system or return the card to spares stock.