



LIMITED RELEASE

**SDS/VCO Generic  
Release Notes  
V4.2 FSR00 PUN 24**

61220300042-OCR

**NOTE:** This equipment has been tested and found to comply with the limits for a Class A digital device pursuant to Part 15 of FCC Rules. These limits are designed to provide reasonable protection against harmful interference when this equipment is operated in a commercial environment. This equipment generated, used, and can radiate radio frequency energy and, if not installed and used in accordance with the instruction manuals, may cause interference in which case the user will be required to correct the interference at his/her own expense.

**NOTICE:** Customers connecting this device to the network shall, upon request of the telephone company, inform the telephone company of the particular lines such connections are made, the FCC registration number, and ringer equivalence number of this device. This information is contained on the label located on the rear panel of the system.

If this device causes harm to the network, the telephone company may discontinue your service temporarily. If possible, they will notify you in advance. But if advance notice isn't practical, you will be notified as soon as possible. You will be advised of your right to file a complaint with the FCC.

Your telephone company may make changes in its facilities, equipment, operations, or procedures that could affect the proper operation of your equipment. If they do, you will be notified in advance to give you the opportunity to maintain uninterrupted service.

If you experience trouble with the system, please contact Summa Four, Inc., 25 Sundial Avenue, Manchester, NH 03103-7251, (800) 978-6624 for repair information. The telephone company may ask you to disconnect this equipment from the network until the problem has been corrected, or you are sure that the equipment is not malfunctioning.

This equipment may not be used on coin service provided by the telephone company. Connection to party lines is subject to state tariffs.

---

Copyright © 1998 by Summa Four, Inc.

P/N 61220300042-OCR

Revised: 3.11.98

Summa Four, Inc. reserves the right to change specifications without prior notice.

For further information about this product, contact:

Summa Four Inc.  
25 Sundial Avenue  
Manchester, NH 03103-7251  
(800) 978-6624

Printed In U.S.A.



This symbol on the product's nameplate means it has been tested by Electronic Testing Labs, Inc.

## Table of Contents

---

### SECTION 1 – CONTENTS OF THE RELEASE

1.1 INTRODUCTION	1-1
1.2 MFCR2 ENHANCEMENT FOR OUTPUTTING DIFFERENT CATEGORIES	1-2
1.3 NETWORK SIDE SUPPORT FOR NET5	1-3
1.3.1 Summary of Features	1-3
1.3.2 The T309 Timer	1-3
1.3.3 RESTART if the Timer T308 Expires Twice	1-4
1.4 BUSY (REORDER) TONE FOR JAPANESE NETWORKS	1-4
1.4.1 User Interface—Convert Reorder Tone To Busy	1-4
1.5 NEW MESSAGES	1-5
1.6 NATIONAL ISDN-2 (NI2)	1-5
1.6.1 New PRI/N Configuration Screen	1-5
1.6.2 ISDN Selectable IEs (Codeset 0)	1-6
1.6.3 Port Display Screen	1-6
1.6.4 D-Channel Messages	1-6
1.6.5 Prompts, Warnings and Error Messages	1-7
1.7 DROP AND INSERT CARD SUPPORT	1-7
1.7.1 Related Documents	1-7
1.7.2 Definitions	1-7
1.7.3 Summary of Features	1-7
1.7.3.1 Card Characteristics	1-7
1.7.3.2 Port Characteristics	1-8
1.7.3.3 Generic Support for the Drop and Insert Card	1-8
1.7.4 Line Card Configuration	1-9
1.7.4.1 DCE or DTE Operation	1-10
1.7.4.2 Bit Packing Order	1-10
1.7.5 Slip Limit	1-11
1.7.6 Card Maintenance	1-11
1.7.6.1 Port States	1-11
1.7.6.2 Card States	1-13
1.7.7 Card Alarm Display	1-14
1.7.8 Port Alarms	1-15
1.7.8.1 FRM Message Support for Alarms	1-15
1.7.9 Diagnostics	1-15
1.7.9.1 Display Card Data	1-15
1.7.9.2 Drop and Insert Port Display Screen	1-16
1.7.10 Host Commands and Reports	1-19
1.7.10.1 \$66 Voice Path Control Command	1-19
1.7.10.2 \$F0 Alarm Condition Report	1-19
1.7.11 Drop and Insert I/O Module	1-19
1.8 ISDN NET5 OVERLAP SENDING AND RECEIVING	1-20
1.8.1 Summary of Features	1-21
1.8.2 Features Not Supported	1-21
1.8.3 User Interface—Overlap Receiving ON/OFF Control	1-21
1.8.3.1 Overlap Receiving Indication	1-22

---

**Table of Contents**

---

1.8.4	Call State Transition	1-23
1.8.5	Call Establishment	1-24
1.8.5.1	Overlap Receiving with Indication from Host Application	1-24
1.8.5.2	Non-Overlap Receiving in Overlap Receiving Operation	1-26
1.8.5.3	Timer Expiry on Overlap Receiving	1-26
1.8.5.4	Overlap Sending with Indication from Host Application	1-27
1.9	JAPANESE ISDN ENHANCEMENTS	1-29
1.9.1	Network-side Japanese ISDN	1-29
1.9.2	Disconnect Message Feature Flag	1-29
1.10	CALL THROUGHPUT PERFORMANCE ENHANCEMENT	1-30
1.11	LIVE UPGRADE	1-30
1.11.1	Summary of Features	1-31
1.11.2	Overview of the Procedure	1-31
1.11.3	Overview of the Steps	1-33
1.11.4	Host Commands and Reports	1-34
1.11.5	Prompts, Warnings and Error Messages	1-35
1.11.5.1	Prepare for Install Messages	1-35
1.11.5.2	Installing New Software Messages	1-35
1.11.5.3	Prepare for Upgrade Messages	1-36
1.11.5.4	Enable/Disable/Configure Optional Software Messages	1-37
1.11.5.5	Card Cut-Over Messages	1-37
1.11.5.6	General Live Upgrade Messages	1-39
1.12	REMOTE FILE TRANSFER (FTP)	1-39
1.12.1	Summary of Features	1-39
1.12.2	FTP Transfer of Files	1-40
1.12.3	FTP Password Configuration Screen	1-40
1.12.4	New Disk Utilities Options	1-42
1.12.5	New Installation Disk Utilities Menu	1-45
1.12.6	New Administrative Console Disk Utilities Menu	1-48
1.12.7	FTP Functions	1-52
1.12.8	Accessing the SDS/VCO via FTP	1-54
1.13	INVERTED E&M	1-58
1.13.1	User Interface—Inverted E&M Selection	1-58
1.14	HOST FAILURE DETECTION	1-59
1.14.1	Summary of Features	1-59
1.14.2	User Interface	1-60
1.15	CONFIGURABLE IP SUBNET MASK	1-61
1.15.1	Summary of Features	1-61
1.15.2	User Interface	1-61
1.16	CORE DUMP	1-63
1.16.1	Functionality	1-63
1.16.2	File Handling	1-63
1.16.3	Maintenance Menu Screen	1-64
1.16.4	Sending a Core Dump File for Analysis	1-65
1.16.5	New FRM Messages for Core Dump	1-65

## Table of Contents

---

1.17 PROBLEMS CORRECTED IN V4.2	1-66
1.18 PROBLEMS CORRECTED IN V4.2 FSR00 PUNS 22, 23, AND 24	1-71
<b>SECTION 2 – SYSTEM REQUIREMENTS</b>	
2.1 INTRODUCTION	2-1
2.2 DATABASE CONFIGURATION	2-1
2.3 HARDWARE REQUIREMENTS	2-1
2.4 FIRMWARE REQUIREMENTS	2-2
2.5 SOFTWARE REQUIREMENTS	2-6
<b>SECTION 3 – UPGRADING TO V4.2 FSR00 PUN 24</b>	
3.1 INTRODUCTION	3-1
3.2 REFERENCES	3-1
3.3 OVERVIEW OF THE INSTALLATION PROCEDURE	3-2
3.4 WHAT YOU NEED	3-4
3.5 BACKING UP THE DATABASE	3-5
3.6 HARDWARE AND FIRMWARE REQUIREMENTS	3-8
3.6.1 Replacing Hardware and Firmware	3-10
3.6.2 Removing and Replacing Through-Hole PROMs and PLDs	3-10
3.6.3 Removing and Replacing Surface-Mount PROMs and PLDs	3-12
3.6.3.1 Replacing Surface-Mount PROMs and PLDs	3-13
3.6.4 Updating the CPU Firmware (68030 Processor)	3-14
3.6.5 Updating the NBC-3 Firmware	3-14
3.6.6 Updating the PRI/N Firmware	3-14
3.7 INSTALLING THE SOFTWARE	3-14
3.7.1 Installing the Generic Software	3-15
3.7.2 Installing Ethernet for Host and SNMP Communication	3-17
3.7.3 Installing Optional Software	3-21
3.8 PERFORMING A DATA BASE CONVERSION	3-22
3.9 INSTALLING THE SOFTWARE ON THE B-SIDE	3-22
3.9.1 Verifying File Synchronization	3-23
3.10 INSTALLING THE MIB SOFTWARE	3-23
<b>SECTION 4 – KNOWN DESIGN CONSTRAINTS</b>	
4.1 INTRODUCTION	4-1
4.2 UPGRADING TO V4.2 ON SDS AND VCO/80 SYSTEMS	4-1
4.3 SIMPLE NETWORK MANAGEMENT PROTOCOL (SNMP)	4-2
4.4 SYSTEM CONFIGURATION UTILITIES	4-2
4.4.1 Peripheral Configuration Utility	4-2
4.4.2 U611120001: Cannot Blank Out NFS Server Name	4-2

## Table of Contents

---

4.5 SYSTEMS CONSIDERATIONS	4-3
4.5.1 U702240001: Timeout Waiting for Console Access	4-3
4.5.2 U702250006: Switchovers Cause Card Alarms with DTG-2	4-3
4.6 SOFTWARE EXCEPTIONS ON SYSTEM CONTROLLER	4-3
4.7 CARD INITIALIZATION	4-3
4.8 DTG-2 CARD ALARMS	4-4
4.8.1 U612120002: Card Alarms for Missing DTG-2 Cards	4-4
4.9 T1 TRUNK CARD SUPPORT	4-4
4.9.1 Slip Conditions in T1-Channel Service Unit (CSU) Connections	4-4
4.9.2 Slip Counts in Card Display Only Updated after 10 Seconds	4-4
4.10 DIGIT COLLECTION	4-4
4.10.1 Optimum DTMF Digit Timing (8-Port DTMF Cards Only)	4-5
4.10.2 Digit Collection Using Reenter/Clear Character (8-Port DTMF Cards Only)	4-5
4.11 IMPULSE RULE PROCESSING	4-5
4.11.1 Timer Variations	4-5
4.11.2 U412204829/TR 4829: TIM FDIG 15 On DRC-24/48	4-5
4.12 RESOURCE GROUP PROCESSING	4-5
4.12.1 Inserting a Port Into a Resource Group	4-5
4.13 CONFERENCING	4-6
4.13.1 Conference Call Timing Delay	4-6
4.14 MVDC-T1	4-6
4.14.1 RAM Diagnostics	4-6
4.15 OPERATIONAL CONSTRAINTS	4-6
4.15.1 Activating Multiple Spans Simultaneously	4-6
4.15.2 U508295234/TR 5234: Adding Cards to End of Configured Data Base	4-6
4.16 CONNECTING TO MODEMS	4-7

## SECTION 5 – KNOWN FUNCTIONAL CONSTRAINTS

5.1 INTRODUCTION	5-1
5.2 SYSTEM ADMINISTRATION	5-2
5.2.1 Functions Not Supported in SNMP	5-2
5.2.2 U507315154/TR 5154: Trace Files Do Not Close	5-2
5.2.3 U507315162/TR 5162: No Automatic Database Conversion	5-2
5.2.4 U508295234/TR 5234: Adding Cards to End of Configured Data Base	5-2
5.2.5 U512071001: Aux1 Alarm Not Set on System Alarms Display Screen	5-2
5.2.6 U604041001: IPRC Voice Prompt Maintenance	5-2
5.2.7 U605010004: Keyboard Type is Reset During System Reboots	5-3
5.2.8 U610030003: FRM51 Error Reading Download	5-3
5.2.9 U611260002: Abort Button	5-3
5.2.10 U705050001: FTP Quote Command Inconsistent	5-3
5.2.11 U705050002: FTP Quote Join Command Error	5-3
5.2.12 U705060001: Can't Set FTP Password on Standby Side	5-4

## Table of Contents

---

5.2.13	U708280004: Wrong size of dbvers.tbl Following Database Conversion	5-4
5.2.14	U803190001: IPRC Call Chain Corruption	5-4
5.3	SYSTEM CONFIGURATION UTILITIES	5-4
5.3.1	U301063881/TR 3881: Selective Tracing Does Not Work	5-4
5.3.2	U411304788/TR 4788: Viewing Software Configuration on Floppy Disks	5-4
5.4	SPECIAL REDUNDANT SYSTEMS CONSIDERATIONS	5-5
5.4.1	U406284594/TR 4594: Lost Class of Service Results in Command Failure	5-5
5.4.2	U606190001: System Host Configuration Update Problem	5-5
5.4.3	U609170001: Prompt Libraries are Not Displayed on Redundant Systems	5-5
5.4.4	U701290006/U508191001: DVC \$9 Timeout on Transfer to Standby	5-5
5.5	DISK OPERATIONS	5-5
5.5.1	U409224673/TR 4673: Database Utility Covers File Access Errors	5-5
5.5.2	U505035026/TR 5026: Formatting a Floppy During Reboot	5-5
5.5.3	U604121001: Mismatch between On-line and Diskette Disk Utilities	5-6
5.6	DIGIT COLLECTION	5-6
5.6.1	TR 2274: Single Digit Collections (8-Port DTMF Cards Only)	5-6
5.6.2	U507315157/TR 5157: Garbled MF Digit Reports Not Sent to Host	5-6
5.6.3	U607290001: Reenter Character Disables DTMF Collection Timers	5-6
5.7	INPULSE/OUTPULSE RULE PROCESSING	5-7
5.7.1	U503234961/TR 4961: RELEASE Inpulse Rule Requires Resource Type	5-7
5.7.2	U608140005: RELEASE DTG Token Does Not Work	5-7
5.7.3	U511211001/TR 5009: Limited Support for RETAIN and RELEASE Token	5-7
5.8	CALL PROCESSING	5-7
5.8.1	U407064606/TR 4606: DASS Ports Stuck in MAINT-NE State	5-7
5.8.2	U410264726/TR 4726: After Switchover, SLIC OGT Keeps Ringing	5-7
5.8.3	U412014797/TR 4797: DASS Ports Getting Stuck in CP_GUARD	5-8
5.8.4	U503064939/TR 4939: Ringing a Port that is Off Hook	5-8
5.8.5	U503284968/TR 4968: Disconnect Fails Unless Port Goes Through Stable	5-8
5.8.6	U505085035/TR 5035: Multiple Host and High Load Causes System Failure	5-8
5.8.7	U505115041/TR 5041: Interval between Seizure and Wink	5-8
5.8.8	U703280005: DRC Attach Time — 70ms Longer	5-8
5.9	COMMAND/REPORT PROCESSING	5-8
5.9.1	U505105037/TR 5037: SIT Tone Detection Failure	5-8
5.9.2	U507315159/TR 5159: Appending Digits via the \$67 Command	5-9
5.9.3	U507315160/TR 5160: Number of Digits to Collect (\$67 Command)	5-9
5.9.4	U507315161/TR 5161: Inpulse Rule Complete (\$DD) Report Processing	5-9
5.9.5	U508175187/TR 5187: \$67 Command and Inpulse Rule—Digit Collection	5-9
5.9.6	U603210001: NSB 02 Returned for \$65 and \$49 Commands	5-9
5.9.7	U703200001: \$91 Command to Save Prompt, Fills Disk	5-10
5.9.8	U705010002: \$90 Command Changes Hook State	5-10
5.10	INITIALIZATION	5-10
5.10.1	U311104202/TR 4202: System Sends \$DC Report too Early	5-10

## Table of Contents

---

5.11 NBC-3	5-10
5.11.1 U704140001: Cards Not Downloading After DID	5-10
5.12 DTG AND DTG-2	5-11
5.12.1 U608140004: Problems with Tone Ports during Switchovers	5-11
5.12.2 U610020003: DTG/DTG-2 Add/Delete during Outpulsing	5-11
5.12.3 U703120001: Deleting a DTG from the Database Stops Outpulsing	5-11
5.13 FOUR SPAN CARDS	5-11
5.13.1 U507201007: Processing WINK Command	5-12
5.13.2 U603151001: Inconsistent Handling of Channels on Four Span E1	5-12
5.13.3 U604260001: Testing Patterns from TTS-3 Analyzer Causes Errors	5-12
5.13.4 U606101001: MVDC-T1s/Four Span T1s Generate FRM90 before Download	5-12
5.13.5 U606241001: Four Span T1/E1 Internal Errors During Boot	5-13
5.13.6 U611140005: Problem with Four Span T1 on Switchover	5-13
5.13.7 U611250003: FRM523 Queue Overflow	5-13
5.13.8 U611260001: Rotary Resource Group	5-13
5.13.9 U704140004: Display ACTIVE while Downloading	5-13
5.13.10 U710290005: MVDC T1 Fails to Clear Alarms	5-13
5.13.11 U710300006: FXSGS Configuration Does Not Process All Calls	5-14
5.13.12 U710300008: Aborted Download Does Not Resume After Switchover	5-14
5.13.13 U710310001: Display Card Data Screen Not Recording Slips	5-14
5.14 MISCELLANEOUS CARD ISSUES	5-14
5.14.1 U409124662/TR 4662: UTC Firmware Causing T1 INIT Code F Error	5-14
5.14.2 U505105038/TR 5038: Reorder Tone is Not Reported/Detected (UK)	5-14
5.14.3 U507195126/TR 5126: A2 SLIC Stuck in CP_OUTPULSE	5-14
5.14.4 U603021003: IPRC Load Problems with more than 22 Seizures	5-14
5.14.5 U604040002: IPRC Load Problem	5-15
5.14.6 U608090005: Erroneous Minor Alarms on Four Span E1	5-15
5.14.7 U608140002: Remote Alarm Problems with DPNSS Ports	5-15
5.14.8 U609230005: Outgoing T1 Stuck in CP_OUTPUL	5-15
5.14.9 U610110003: Subrate Switch Card Download Broadcast	5-15
5.15 MULTIPLE HOST CONNECTIONS	5-15
5.15.1 U605091001: Major Alarm Not Set on Loss of Hosts	5-15
5.16 TELEROUTER	5-16
5.16.1 U606041001: TeleRouter \$D5 (Routing Action) Reports	5-16
5.16.2 U606030001: Access of TeleRouter Routes	5-16
5.17 SIMPLE NETWORK MANAGEMENT PROTOCOL (SNMP)	5-16
5.17.1 Functions Not Supported	5-16
5.17.1.1 V4.2 FSR00 PUN 24 Release	5-16
5.17.1.2 Management Information Base	5-16
5.17.2 U604241001: Card Activate Errors Not Returned in SNMP	5-17
5.17.3 U606051001: Zero Value for hostRemotePort Not Accepted	5-17
5.17.4 U606051002: Zero Value for hostType Not Accepted	5-17
5.17.5 U606061002: Adding Same Card in Resource Group Twice	5-17
5.17.6 U606201001: Configuring Hosts	5-17



## Table of Contents

---

5.17.7	U609170001: Prompt Libraries are Not Displayed on Redundant Systems	5-17
5.17.8	U606201002: Committing Changes to the Data Base	5-18
5.17.9	U606211001: Modifying TimingCard Objects	5-18
5.17.10	U608130005: SNMP Resource Group Configuration Problem	5-18
5.17.11	U609170001: Prompt Libraries are Not Displayed on Redundant Systems	5-18
5.17.12	U609250016/U609250017: SNMP Modification Tables	5-18
5.17.13	U708140005: D&I Card Not Supported Via SNMP	5-18
5.18	ETHERNET	5-19
5.18.1	U608080006: Problem with Ethernet Install	5-19
5.19	ISDN ISSUES	5-19
5.19.1	U401054297/TR 4297: ISDN Ports Remain in DISC_REQ State	5-19
5.19.2	U707300002: SETUPACK Message Type missing; required for Overlap Receiving/ Sending	5-19
5.20	INTERNATIONAL ISSUES	5-19
5.20.1	U505125048/TR 5048 Chile CPA Does Not Detect any Tones	5-19
5.20.2	U505155052/TR 5052: Finland CPA Does Not Detect Tones	5-19
5.20.3	U505165056/TR 5056: Colombia DTG Does Not Outpulse Digits	5-19
5.20.4	U505255069/TR 5069/TR 5068: Colombia CPA Tone Detection Problems	5-20
5.20.5	U508075168/TR 5168: Multiple MFCR2 Cards with Colombia V19.02	5-20
5.20.6	U803110013: Telnet Logout Locks Console	5-20
 <b>APPENDIX A – DATABASE CARD CONFIGURATION</b>		
A.1	INTRODUCTION	A-1
A.2	Database Card Installation	A-1
A.2.1	Add Cards to the Database	A-1
A.2.2	Configure the Cards in the Database	A-3
A.2.3	Assign the Ports a Resource Group	A-3
A.2.4	Activate the Cards	A-3
A.3	Card Survey Forms	A-3
 <b>APPENDIX B – RE-INSTALLING V4.2 FSR00 PUN 24</b>		
B.1	INTRODUCTION	B-1
B.2	REFERENCES	B-1
B.3	Overview of the Installation Steps	B-2
B.4	What You Need	B-2
B.5	Installing the GENERIC Software	B-3
B.6	Installing Ethernet Software for Host and SNMP Communication	B-6
B.7	Installing Optional Software	B-8
B.8	Installing the Software on the B-side	B-10
B.9	Time-slot Allocation License	B-10
B.10	The MIB - Supplemental disk Files	B-10

## Table of Contents

---

### **APPENDIX C – Configuring the MIB**

C.1 INTRODUCTION	C-1
C.2 Installing the MIB files	C-1
C.3 SETTING UP snmptalk	C-2
C.3.1 Public Access	C-2

## List of Figures

---

Figure 1.1: System Features Screen with Normal/Reorder Tone Selection	1-4
Figure 1.2: PRI/N Configuration Screen for NI-2	1-6
Figure 1.3: Drop and Insert Card Configuration Screen	1-9
Figure 1.4: Card Maintenance Screen	1-13
Figure 1.5: Card Display Screen	1-16
Figure 1.6: Drop and Insert Port Display Screen	1-17
Figure 1.7: System Features Screen with NET5 Overlap Receiving	1-22
Figure 1.8: Overlap Receiving with Indication (SETUP_ACK) from Host Application	1-25
Figure 1.9: T302 Expiry and Call Clearing from the Card Download	1-27
Figure 1.10: Overlap Sending with Indication (SETUP_ACK) to Host Application	1-28
Figure 1.11: System Features Screen with Send All ISDN Disconnect Report	1-30
Figure 1.12: Live Upgrade on the Maintenance Menu	1-32
Figure 1.13: Live Upgrade Control Menu	1-32
Figure 1.14: Overview of the Upgrade Process	1-34
Figure 1.15: FTP Password Configuration Screen Access from the System Configuration Screen	1-41
Figure 1.16: FTP Password Configuration Screen	1-42
Figure 1.17: The Installation Disk Utilities Menu	1-45
Figure 1.18: The Administrative Console Disk Utilities Menu	1-48
Figure 1.19: Programmable Trunk Card Configuration Screen	1-59
Figure 1.20: Host Configuration Screen	1-60
Figure 1.21: Ethernet/NFS Configuration Menu	1-62
Figure 1.22: Maintenance Menu—Core Dump Option	1-64
Figure 3.1: Maintenance Menu	3-5
Figure 3.2: Disk Utilities Menu	3-6
Figure 3.3: Aligning PROM or PLD Pins	3-11
Figure 3.4: Notch Orientation for Integrated Circuit	3-11
Figure 3.7: PLD Alignment	3-13
Figure 3.8: Installation Utilities Menu	3-16
Figure 3.9: Ethernet Installation Utilities Menu	3-18
Figure 3.10: Ethernet Configuration Menu	3-18
Figure 3.11: Optional Software Installation Utilities Menu	3-21

## List of Tables

---

Table 1.1: New and Changed ISDN IEs	1-6
Table 1.2: Drop and Insert Card Configuration Screen Parameters	1-10
Table 1.3: Bit Mapping at 56K and 64K Bits/Second—Transmit and Receive	1-11
Table 1.4: Drop and Insert Port States	1-12
Table 1.5: Drop and Insert Card States	1-14
Table 1.6: D&I Port Major States	1-18
Table 1.7: D&I Port Supplementary States	1-18
Table 2.1: Common Firmware Requirements	2-2
Table 2.2: Domestic (U.S.) Firmware Requirements	2-6
Table 2.3: V4.2 FSR00 PUN 24 Software Requirements	2-7
Table 2.4: V4.2 FSR00 PUN 24 Optional Products Software Requirements	2-8
Table 3.1: File Sizes	3-3
Table 3.2: Upgrading Hardware & Firmware: Current Configuration	3-8
Table 3.3: Upgrading Hardware & Firmware: New Cards	3-9
Table C.1: snmptalk Setup Commands	C-2

---

# Section 1

# CONTENTS OF THE RELEASE

---

## 1.1 INTRODUCTION

Generic V4.2 is the system software for all SDS and VCO Series systems. V4.2 FSR00 PUN 24 is an incremental release that consists of the following components:

- Five (5) Generic V4.2 FSR00 PUN 24 software diskettes that contain the Generic V4.2 PUN 24 files. These files include the database files and the card download files.
- Optional diskettes. For example: TeleRouter, Ethernet (includes the MIB Supplemental disk), ISDN, NFAS, and NI-2.

Refer to *Appendix B* for information on installing the Generic software, or *Section 3* for information on upgrading your system to V4.2 FSR00 PUN 24.

If any of the required diskettes or technical publications are not in this package, contact Summa Four, Inc. Technical Support at 1-800-9SUMMA4.

*NOTE: This PUN 24 release documentation is an accumulation of changes to the Generic V4.2 FSR00 since its release and includes PUN 22, 23, and 24 changes.*

New systems shipped with V4.2 software have all generic and download files installed on the system hard disk. If you need to re-install the software, you must install all files from the five V4.2 diskettes onto the hard drive as outlined in *Appendix B*. If you are upgrading to V4.2 FSR00 PUN 24, you must install all files from the five V4.2 diskettes onto the hard drive as part of the overall upgrade steps outlined in *Section 3*.

Generic V4.2 FSR00 PUN 24 provides full upgrade compatibility with previous versions of Generic software.

The Generic V4.2 FSR00 PUN 24 release includes:

- MFCR2 Enhancement for Outpulsing Different Categories — refer to *Section 1.2*
- Fixes since PUN 23 — refer to *Section 1.18*
- Support for the new 16Mb, 33MHz CPU

The Generic V4.2 FSR00 PUN 23 release includes:

- NET5 Network Side Support — refer to *Section 1.3*
- A new Feature Flag for Busy Tone in Japanese Networks — refer to *Section 1.4*
- New Messages — refer to *Section 1.5*

The Generic 4.2 FSR00 release included:

- National ISDN-2 (NI-2) Option — refer to *Section 1.6*
- Drop and Insert Card Support — refer to *Section 1.7*

- ISDN NET5 Overlap Sending — refer to *Section 1.8*
- Network-side Japanese ISDN — refer to *Section 1.9*
- Call throughput performance enhancement — refer to *Section 1.10*
- Live Upgrade — refer to *Section 1.11*
- Remote File Transfer — refer to *Section 1.12*
- Inverted E&M — refer to *Section 1.13*
- Host Failure Detection — refer to *Section 1.14*
- Configurable IP Subnet Mask — refer to *Section 1.15*
- Core Dump — refer to *Section 1.16*

## 1.2 MFCR2 ENHANCEMENT FOR OUTPUTTING DIFFERENT CATEGORIES

In order to output a category digit, a user has to define an output rule with the token OPCAT. The OPCAT token takes a single digit field as a parameter where the category digit can be specified. If a user wants to output "n" different category digits at different times, "n" different output rules are required, where each rule would specify a different digit. Since there are a limited number of output rules, this could be a resource limitation.

Two new tokens have been added to address this problem. These are the OPCAT2 and IPCAT2 tokens. See also fix U802090003 in *Section 1.17*.

The user is now able to specify the new OPCAT2 token in the output rule table and the new IPCAT2 token in the input rule table via the screen manager or via SNMP.

Both of these new tokens are fieldless tokens. That is, there is no parameter field associated with them.

The call record structure currently supports five fields whose values can be supplied by a \$69 host command at run time. These fields are:

- ANI field
- Field 1
- Field 2
- Field 3
- Field 4

The call record is expanded to include a sixth field which is called Field 6 (not Field 5 because code uses 0, 4, and 5 to refer to the ANI field). Field 6 in the call record is capable of holding a single digit. (the category digit).

The \$69 host command is used to populate Field 6 with a category digit at run time. Now all a user need do is specify an output rule with the OPCAT2 token. Any time the OPCAT2 token is encountered in a rule, the Generic extracts the category digit from the call record if Field 6

has been populated (the call record maintains information as to the presence of data in a field) and also the size of the data \*number of digits).

A single rule can then be used to specify any category digit (as opposed to a single rule per-digit). The user sends a \$69 host command at run time that specifies the category digit using Field 6 in the digit output pulse control segment of the command where the command specifies an output pulse rule that contains the OPCAT2 token.

The IPCAT2 token is provided so the category digit can be collected from an inpulse stream. When processing an inpulse rule, if the IPCAT2 token is encountered, a single digit is collected and stored as a Field 6 digit in the call record.

## 1.3 NETWORK SIDE SUPPORT FOR NET5

Network side NET5 ISDN Primary Rate Interface is a variant of CCITT and is a separate product from User side NET5. The NET5 Network side product provides the functionality of the User side product plus the Network side capabilities.

### 1.3.1 Summary of Features

Functionality common to both Network and User side NET5:

- All features of the User side are supported
- The message set
- The information element set Network Side functionality:
- Modified User Side call states, timers, and event processing to support the Network Side
- Outgoing RESTART after expiry of timer T308
- Mandatory network timers
- Implementation of timer T309

Additional support for the following (both Network and User Side):

- Advice of Charge supplemental service
- CRC4 programmability for all countries
- Sending Status inquiry

### 1.3.2 The T309 Timer

The T309 timer is optional for the User side, but is mandatory for the Network side. Per the ETSI specification, "In case of data link failure the network stops all timers relative to the call, releases the call inside and starts timer T309. It then sends a DISCONNECT message with cause 41 'Temporary failure' and clears at the other party's interface. If the low layer recovers normally before timer T309 times out, the network sends a DISCONNECT message and clears at that interface."

### 1.3.3 RESTART if the Timer T308 Expires Twice

When a RELEASE is sent as a response to a DISCONNECT message, the layer3 starts the timer T308. If a RELEASE message is not received within time T308, a RELEASE message is sent for the second time. If the other side continues to fail to respond, a RESTART message is sent to the other side and the cal is cleared normally.

## 1.4 BUSY (REORDER) TONE FOR JAPANESE NETWORKS

A new feature flag has been added to the System Features screen to provide selection of an alternate busy tone for Japanese networks which use a normal busy tone instead of the reorder tone during PSC (Permanent Signaling Condition) processing on a port. See U711120006 in *Section 1.18*

### 1.4.1 User Interface—Convert Reorder Tone To Busy

The default setting of the new feature flag is "N" which results in the normal reorder tone during PSC. When this flag is set to a "Y" the normal busy tone is presented instead of reorder. See *Figure 1.1*.

SYSTEM FEATURES			
FEATURES	ALLOWED (Y,N)	FEATURES	ALLOWED (Y,N)
Redundant System	Y	Send All ISDN Connect Reports	N
Output Periodic Alarm Reports	N	Enable \$66 Cmd Host Checking	N
Card/Alarm Status at Init.	N	Cut Thru For Non-ISDN Alerting	N
Manual Intervention For SLIP/OOF	N	Enable 4th Column DTMF	N
Enable Grace Timing on Null Rule	N	Set MVDC-Backplane to A-Law	N
Disable Card Error Report/Reset	N	Enable AllPortsDeactivated Alrm	N
Enable Digit Field Reporting	N	\$EA Reports on DChannel RESTART	N
Suppress PSC/Rule Abort Messages	Y	Enable NET5 Overlap Receiving	Y
Enable Host Password Check	N	Send All ISDN Disconnect Report	N
Force Bearer/Lap Activation	N	<b>Convert Reorder Tone To Busy</b>	<b>N</b>
Enable MFC-R2 Supervised Clear	N		
Enable SLIC Guarded Disconnect	N		
Enable CPA Monitor Disconnect	N		
Revert to Basic Redundancy	N		
Send Reports Before Guard Time	Y		
Enable ISDN Manual Disconnect	N		

Figure 1.1: System Features Screen with Normal/Reorder Tone Selection



## 1.5 NEW MESSAGES

There are two new diagnostic tests that are now run on an MVDC T1 card while it is in the diagnostic state. See U711010001 in *Section 1.18*. The messages are:

"DGN45: %s Test Aborted, Card Went OOS -ATP- %d Tests Executed"

"DGN46: %s Test Aborted, Card Went OOS -STF- %d Tests Executed, %d Failed"

## 1.6 NATIONAL ISDN-2 (NI2)

The National ISDN-2 (NI2) option provides call processing and administrative support for ISDN PRI calls. User-Side and User-Side Symmetrical, Q.921/931 access to National ISDN-2 switch type, is configurable for each PRI/N card in the system. Modifications to the download for the PRI/N card were done to support National ISDN-2. The modified software is in the prin.dwn and pri.dwn download files. No changes to the hardware or firmware are required.

You must install ISDN PRI or ISDN NI2 as a separate step during installation.

Refer to the *National ISDN-2 Supplement* (P/N 61230200542) for detailed information on National ISDN-2.

### 1.6.1 New PRI/N Configuration Screen

Enable National ISDN-2 by selecting the NI2 switch type in the PRI Configuration screen. The NI2 switch type is only enabled if the NI2 option of PRI/N has been purchased. Refer to *Figure 1.2*.

```

          P R I   C A R D   C O N F I G U R A T I O N

CARD LOCATION: R,L,S 1 1 15   TYPE:   Primary Rate Interface
                               STATUS: Maintenance

DISPLAY PROTOCOL PARAMETERS _
ACCESS TYPE: USER           TRX CLOCK: SCLK  CA IP RULE: 01  SLIP MAINT LIMIT: 255
SWITCH TYPE: NI2 REF CLOCK: RCVD  NCA IP RULE: 03   OOF  MAINT LIMIT: 17
SPAN LENGTH: 0-133         SPAN TYPE: ESF   A/Mu LAW: Mu

          PORT      NAME      GROUP   GRP NAME   COS
          ----      -
          1          _____
          2          _____
          3          _____
          4          _____
          5          _____
          6          _____
          7          _____
          8          _____
    
```

Figure 1.2: PRI/N Configuration Screen for NI-2

### 1.6.2 ISDN Selectable IEs (Codeset 0)

The NI2 software contains a new ISDN selectable IE: NET FAC. There is also a change in the hex value for FACILITY.

**Table 1.1: New and Changed ISDN IEs**

Value	Meaning	Hex Value
FACILITY	Facility	1C
NET FAC	Network-specific Facilities	20

*Note: In previous versions, the FACILITY hex value was 20. Note that in this release, the NET FAC hex value is 20 and the FACILITY hex value is 1C.*

### 1.6.3 Port Display Screen

The OOS-FE and MAINT-FE port states are not supported.

### 1.6.4 D-Channel Messages

The ISDN D-Channel SERVICE messages are not supported. You cannot take B-channels out-of-service from the far end.

## 1.6.5 Prompts, Warnings and Error Messages

The following two messages have been added to support NI-2.

### ISDN-NI2 Option Not Installed

You selected the NI2 switch type but National ISDN-2 software is not installed. Install the ISDN NI2 software first.

### ISDN-PRI Not Installed

You selected the ATT4E, ATT5E, or NTI switch type but ISDN PRI software is not installed. Install the ISDN PRI software first.

## 1.7 DROP AND INSERT CARD SUPPORT

The Drop and Insert (D&I) card provides DS0 access to the SDS/VCO system. This card supports a maximum of eight interfaces per card that operate at either 56 KB or 64 KB. It is configurable as DCE or DTE with normal or reverse bit-packing. This card supports both (user supplied) RS-449 and V.35. The V.35 cable can be ordered from Summa Four (refer to the *Technical Description: Drop and Insert Card* for more information). The Drop and Insert card can be inserted into the system while the system is active.

Administration of the card is done through the existing System Administration Console. Configuration messages are sent to the card from the Generic through the NBC-3 interface.

### 1.7.1 Related Documents

*Technical Description: Drop and Insert Card*

*System Administrator's Guide*

*Programming Reference*

### 1.7.2 Definitions

**Local loopback**—PCM time slot from the backplane looped back to the backplane. This loopback is intended for testing the board. It is configured by moving a port to the Diagnostics state.

**Remote loopback**—Bit stream from customer equipment looped back to the customer. This loopback is for testing the cabling and MDF connections. There is no requirement to test the board circuitry, so the loopback occurs close to the MDF.

Local and remote loopback is configured by changing the card state to Diagnostics.

### 1.7.3 Summary of Features

#### 1.7.3.1 Card Characteristics

The Drop and Insert Card has the following characteristics:

- New eight-port card type

- Card maintenance states:  
Active  
Maintenance  
Diagnostics  
Out-Of-Service

#### 1.7.3.2 Port Characteristics

- Supports DS0 connections and the following port connected states:  
DS0\_IDLE  
DS0\_CONN  
DS0\_MAINT
- Each port has a set of programmable parameters:  
56KB or 64KB  
DCE or DTE operation  
Normal or reverse bit-packing order  
Slip threshold for alarming
- Individual port maintenance states:  
Active  
Diagnostics  
Out-Of-Service  
Alarm  
  
Individual port alarms:  
Loss of Clock  
Slip Threshold Reached

#### 1.7.3.3 Generic Support for the Drop and Insert Card

The above card characteristics are mapped into the generic software V4.2 FSR00 as follows:

- New administration screens: Drop and Insert Card Configuration, and Drop and Insert Port Display
- No impact on ASIST or TeleRouter

The existing administration screen support for the Drop and Insert card are:

- The Card Summary—provides access to the Drop and Insert Card Configuration screen
- The Card Display screen—displays new port maintenance states
- The Card Alarm Display—supports new per-port alarms
- The System Alarm Display—supports new per-port alarms
- The Set Up Paths

Host command and report support:

- \$66 command to set connections
- \$F0 alarm report to support new port alarms
- \$90 command to activate/deactivate ports

New FRM messages:

- FRM342: D&I Slip Limit Reached, RLSP 1,1,11,4
- FRM343: D&I Loss of Clock Failure RLSP 1,1,11,4
- FRM373: D&I Internal Message Length Error, RLS 1,1,11

### 1.7.4 Line Card Configuration

The Drop and Insert Card Configuration screen (*Figure 1.3*) has been added so that users can configure the eight ports on the Drop and Insert card.

PORT	DATA RATE	TERMINATION	BIT PACKING ORDER	SLIP ALARM THRESHOLD
1	64KB	DCE	NORMAL	1
2	64KB	DCE	NORMAL	1
3	64KB	DCE	NORMAL	1
4	64KB	DCE	NORMAL	1
5	64KB	DCE	NORMAL	1
6	64KB	DCE	NORMAL	1
7	64KB	DCE	NORMAL	1
8	64KB	DCE	NORMAL	1

Figure 1.3: Drop and Insert Card Configuration Screen

Table 1.2 outlines the card's configuration parameters for each port.

**Table 1.2: Drop and Insert Card Configuration Screen Parameters**

Field	Options	Description
Data Rate (Selectable)	64KB 56KB	Each serial port is capable of synchronous operation at either 64Kbits/sec or 56Kbits/sec. When operating at 64 Kbits/second, each 8 bits of data received is placed into a PCM time slot. When operating at 56Kbit/sec, each 7 bits of data received is placed into a PCM time slot in the most significant 7 bits.
Termination (Selectable)	DCE DTE	DCE = Data Communication Equipment DTE = Data Terminating Equipment In DCE operation, the D&I port supplies the clocking. In DTE operation, the customer equipment supplies both transmit and receive clocks.
Bit Packing Order (Selectable)	Normal Reverse	The bits may be packed into a PCM byte in normal or reverse order.
Slip Alarm Threshold (Numeric Entry)	0-255 (0 disables alarming)	The slip limit is used to set up a threshold value for slip errors. The slip alarm threshold defines the number of slips that need to occur before an alarm is declared. In DTE mode, when the card detects that a slip threshold has been reached, it sends the slip error report to the generic. The user sees a card alarm for exceeding the threshold in the Port Display screen.

#### 1.7.4.1 DCE or DTE Operation

##### DCE Operation

When a port is configured for DCE operation, the port uses the system clock to create the transmit and receive clocks. When configured this way, the transmit and receive data path is not subject to data slips. This is the preferred configuration.

##### DTE Operation

When a port is configured for DTE operation, the port uses the received clocks to transmit data as well as receive data. Since receive clocks may not be locked to the SDS/VCO system clock, the transmit and receive data paths are subject to data slips.

#### 1.7.4.2 Bit Packing Order

Users may select normal or reverse bit ordering. The bits may be packed into a PCM byte in normal or reverse order as shown in Table 1.3:

**Table 1.3: Bit Mapping at 56K and 64K Bits/Second–Transmit and Receive**

Mode	Bit 7 MSB	Bit 6	Bit 5	Bit 4	Bit 3	Bit 2	Bit 1	Bit 0 LSB
64 Kbits/ sec Normal	1st bit	2nd bit	3rd bit	4th bit	5th bit	6th bit	7th bit	8th bit
56 Kbits/ sec Normal	1st bit	2nd bit	3rd bit	4th bit	5th bit	6th bit	7th bit	Fixed at 0
64 Kbits/sec Reverse	8th bit	7th bit	6th bit	5th bit	4th bit	3rd bit	2nd bit	1st bit
56 Kbits/sec Reverse	7th bit	6th bit	5th bit	4th bit	3rd bit	2nd bit	1st bit	Fixed at 0

### 1.7.5 Slip Limit

Administrators use the Slip Limit to define a threshold value for slip errors. When the number of slips is greater than the slip limit, a Slip Error report is sent from the card.

### 1.7.6 Card Maintenance

The Drop and Insert card appears in the list of cards in the Card Maintenance screen. Select Drop & Insert Card from the list to add it to the system. When the card is added, eight ports are added to the database. Each port reserves a time slot on the backplane for transmission onto the PCM bus.

#### 1.7.6.1 Port States

Administrators can activate or deactivate individual ports, or place them in diagnostic mode. To do this, type **P**, for Port Definition, in the Card Maintenance screen's command field, then indicate the location of the card (R,L,S). When the card ports are displayed, you can designate one of the following port states: ACTIVE (**1**), OOS (**0**), or DIAG (**D**). The system may also place the port into ALARM (**A**) state. Refer to *Table 1.4* for a definition of the port states and *Figure 1.4* for a sample Card Maintenance and port state screen display.

**Table 1.4: Drop and Insert Port States**

Char.	State	Description	Notes
1	ACTIVE	Ports ready for connection.	None
0	OOS	Port connection can be made with SET PATH screen.	Users take the port out of service by entering a 0 in the port field. Users are warned if the port has connections and have the option to abort the operation.
D	DIAG	<i>This is a new port state.</i> The PCM time slots of the port are looped back to the SDS/VCO backplane.	In this state, SET PATH may be not done.
A	ALARM STATE	The port has reached the Slip Threshold.	This port state is designated by the system. The user does not set this state; however, the user does set the Slip Threshold upon which this state is triggered.

In *Figure 1.4*, the ports on the D&I card in (R,L,S) 1-1-10 are in the following modes:

- Port 1—active mode
- Port 2—out of service
- Port 3—diagnostic mode
- Port 4—alarm state
- Ports 5 through 8—out of service



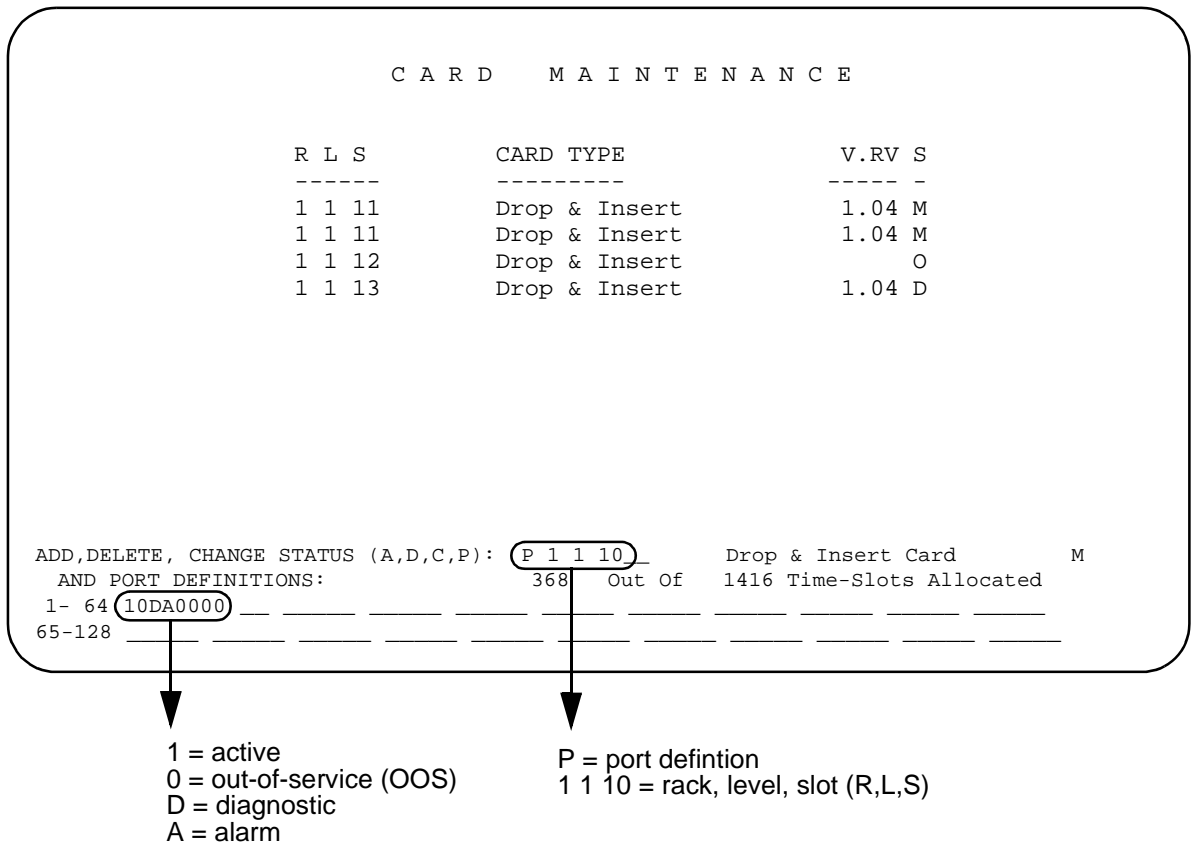

Figure 1.4: Card Maintenance Screen

1.7.6.2 Card States

Possible card states for the Drop and Insert card are: Active (A), Out of Service (O), Maintenance (M), and Diagnostics (D). All card states can be set by the user in the Card Maintenance screen. Refer to the *System Administration Guide* for further details on setting the card states.

Refer to Table 1.5 for an explanation of the card states.

**Table 1.5: Drop and Insert Card States**

State	Description	Notes
ACTIVE	The card is ready for connections. There are no card alarms. There may, however, be port alarms (all ports could have alarms). Only a card alarm or the user can remove a card from the ACTIVE state.	When changing from OOS to ACTIVE, the card goes into the MAINT state until the card activation process completes.
OOS (out of service)	The card is in the database, but out of service. No connections can be made. There is no communication from the system controller to the card.	When the user moves the card to the OOS state, the NBC/NBC-3 resets the card, and communication to the card ends. Users are warned if the card has connections and have the option to abort the operation. If the operation is not aborted, communication is dropped. In addition, if the NBC/NBC-3 detects a card communication failure, the card may go out-of-service (OOS).
MAINT (maintenance)	This state change is passed to the host. When the card is placed in a MAINT state, the current connections (communications) are completed, but no new connections are allowed. This is also the temporary state of the card when it goes from OOS to ACTIVE.	Temporary state pass-through during card activation. MAINT mode can be set by the administrator and remains in effect until it is changed. Currently, there are no card alarms that move the card to the MAINT state. The Card Failure alarm moves the card to the OOS state.
DIAG (diagnostics)	Enables trunk card diagnostics on the D&I card.	When in the DIAG state, the active ports are placed in (local and remote) loopback state.

### 1.7.7 Card Alarm Display

The Card Alarm Display displays alarms present on the Drop and Insert card. Card alarms include:

- Slip Limit Reached (per port)
- Loss of Clock (per port)

The following are examples of the alarm display:

```

RLS  ALARM STATE
114  MI D&I Slip Limit Reached port 1
114  MA D&I Loss of Clock port 2
  
```

## 1.7.8 Port Alarms

Each port on the card has the following associated alarms:

- Slip Error
- Loss of Clock

The Drop and Insert card can detect slips on each port. The card keeps track of the number of slips and reports a Slip Limit Reached when the count exceeds the slip threshold specified in the Card Configuration screen.

When a D&I port is selected to operate in DTE mode, the port may lose its transmit and receive clocks. When the system detects a Loss of Clock on a port, a Loss of Clock alarm is reported. There are no Loss of Clock events when the port is configured in DCE mode.

*Note: The Drop and Insert card does not differentiate between transmit and receive slips or Loss of Clock.*

### 1.7.8.1 FRM Message Support for Alarms

The following FRM messages are used to declare the per port D&I alarms:

- FRM342: D&I Slip Limit Reached, RLSP x, x, xx, x
- FRM343: D&I Loss of Clock Failure RLSP x, x, xx, x
- FRM373: D&I Internal Message Length Error, RLS x, x, xx

## 1.7.9 Diagnostics

Diagnostics are supported from the system administration console. Administrators may define path set ups. Refer to the *System Administration Guide* for information on defining paths.

### 1.7.9.1 Display Card Data

The Drop and Insert card uses the existing Card Display screen. The Display Card Data option displays the card's:

- Rack, level, and slot information—R,L,S
- First Port Address—1st Port Adr
- Card Type—Card Type
- Firmware Version—FW
- Card Status—Card Status
- Communication Errors—Comm Errors
- Polling Status—Poll Queue

The Card Display screen displays the status of the eight ports on the card. The Port Available section indicates whether the port is Active or Disabled along with a field for alarm information (Alarm States). If a port has reached the Slip Threshold, an A is displayed for that port. Refer to *Table 1.4* for information on the port states.

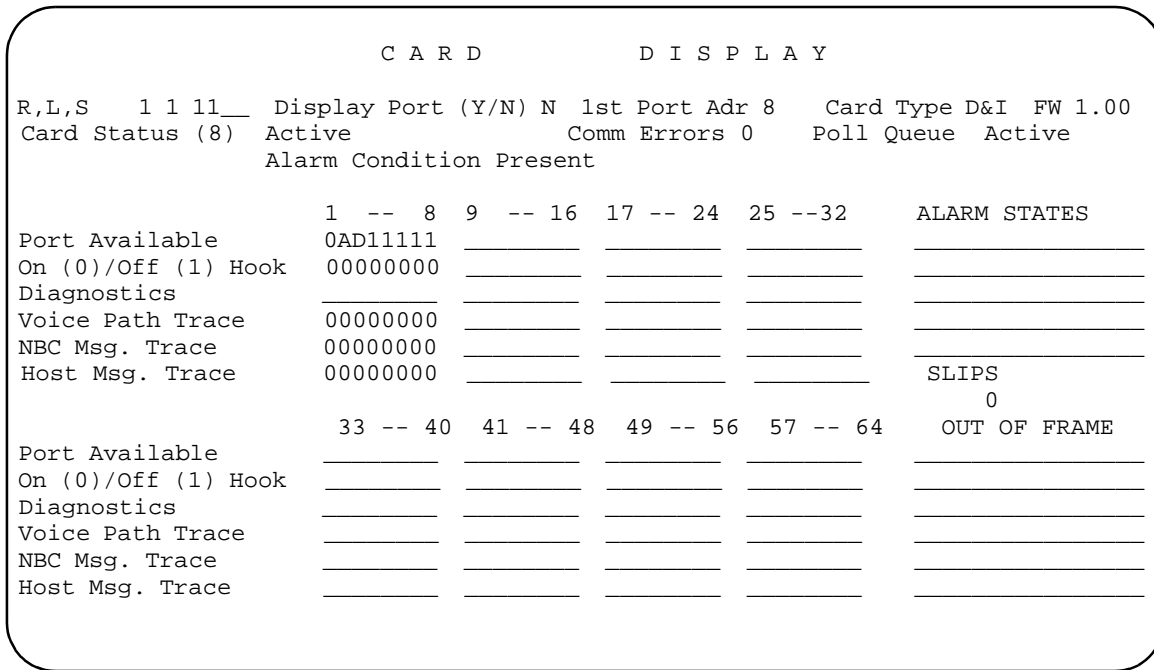

Figure 1.5: Card Display Screen

### 1.7.9.2 Drop and Insert Port Display Screen

The Drop and Insert Port Display screen displays port connections, port address, current major and supplementary state conditions, the RLSP, and slips. All other information, such as rules, tokens, resource group, and conference and call information, does not apply to the Drop and Insert card. All matrix connections are made through the Voice Path Control command (\$66).

```
          D R O P   A N D   I N S E R T   P O R T   D I S P L A Y
RLSP: 1 1 11 1 PA 8          TRACE: Host 0  NBC 0  Voice 0
CURRENT STATE
Major      DSO_MAINT
Supplementary M_ALARM      Connected To RLSP  _ _ _ _ _ PA 4C0

                                ALARM STATES
                                Loss of Clock
                                Slip Threshold Reached

                                SLIPS
                                120
```

Figure 1.6: Drop and Insert Port Display Screen

When in DTE mode, the following alarms are reported for each port on the card.

- Slip Error
- Loss of Clock

Note that the Drop and Insert card does not differentiate between transmit and receive slips.

#### Slip Error

In DTE mode, the Drop and Insert card can detect slips on each port. The Drop and Insert card keeps track of the number of slips and reports a Slip Limit Reached when the count exceeds the slip threshold set by the administrator in the Card Configuration screen.

#### Loss of Clock

When the Drop and Insert port is selected to operate in DTE mode, the port may lose its transmit and receive clocks. When a Loss Of Clock is detected on a port, a Loss of Clock Error is reported. There are no Loss of Clock events when the port is configured in DCE mode.

#### Major and Supplementary Port States

The Major and Supplementary port states shown in the Drop and Insert Port Display screen are summarized in the following tables. Refer to *Figure 1.6*.

**Table 1.6: D&I Port Major States**

<b>State</b>	<b>Description</b>
DS0_IDLE	The port is active and idle.
DS0_CONN	The port has a DS0 connection.
DS0_MAINT	The port has been placed in a maintenance state by the user or is considered OOS due to an alarm.

**Table 1.7: D&I Port Supplementary States**

<b>State</b>	<b>Description</b>
M_OOS	The port has been taken OOS via the Admin screen or the host \$90 Change Port Status command.
M_DIAG	The user has placed the port in the local loopback state. The SDS/VCO PCM time slots are looped back to the backplane.
M_PATH	The user has placed the port in the diagnostic state and then made a connection with the SET PATH screen.
M_ALARM	The port is in an alarm state.

While the Port Display is active (monitoring a port which is in DTE mode), it queries the card every 30 seconds for the slip count.

The card only resets the slip count if a user changes the maintenance threshold or if the slip threshold is reached and the generic resets the count.

## 1.7.10 Host Commands and Reports

The generic uses the following existing host commands and reports to support the Drop and Insert Card.

- \$66 Voice Path Control Command—to connect a PCM time slot to a DS0 port.
- \$90 Change Port Command—to activate/deactivate ports.
- \$81 Hardware Allocation Report—a bit map report that allows the host to match the logical port addresses used in the SDS/VCO commands to their corresponding physical Rack-Level-Slot hardware addresses.
- \$D9 Card Status Report—informs the host of a change in the status of the Drop and Insert Card.
- \$D3 Port Status Report—informs the host of a change in the port status on the Drop and Insert Card.
- \$F0 Alarm Condition Report—indicates the presence of clearance of a system alarm.

The \$66 command and \$F0 reports are discussed in greater detail in the following subsections.

### 1.7.10.1 \$66 Voice Path Control Command

All matrix connections are made through the Voice Path Control Command (\$66). Call processing does not track the calls or the port states. Impulse and outpulse rules do not apply.

An NSB of \$61 indicates that the port specified is busy.

Matrix connections are not changed during a switchover, so the path setups made with the \$66 command are kept during a switchover.

After a reboot, the host must re-establish all the matrix connections.

### 1.7.10.2 \$F0 Alarm Condition Report

The \$F0 Alarm Condition Report is used to indicate the presence or clearance of alarms on the Drop and Insert Card. The three types of alarms reported are: Card Failure, Slip Maintenance Threshold Reached, and Loss of Clock.

The Loss of Clock definition has been added to the Alarm Code identification byte. The Additional Data Bytes identify the port originating the alarm.

## 1.7.11 Drop and Insert I/O Module

Each port is individually capable of operating as either a DCE or DTE as selected by the system administrator. Each port has the following signals:

- Receive clock — INPUT (DTE)/OUTPUT (DCE)
- Receive data —INPUT
- Transmit clock — INPUT (DTE)/OUTPUT (DCE)
- Transmit data — OUTPUT

*Note: The Drop and Insert card cannot be used as a system clock reference source. The Drop and Insert I/O Module has eight female DB9 connectors that provide the necessary signals for RS-449/V.35 connection. The DB9 pinout is as follows:*

Pin 1	GND	Ground
Pin 2	TXCLKA	Transmit Clock A
Pin 6	TXCLKB	Transmit Clock B
Pin 3	TXDATAA	Transmit Data A
Pin 7	TXDATAB	Transmit Data B
Pin 5	RXCLKA	Receive Clock A
Pin 9	RXCLKB	Receive Clock B
Pin 4	RXDATAA	Receive Data A
Pin 8	RXDATAB	Receive Data B

## 1.8 ISDN NET5 OVERLAP SENDING AND RECEIVING

ISDN NET5 Overlap Receiving was supported in V4.0 FSR02. Support for Overlap Sending is being added with V4.2 FSR00. This section describes Overlap Sending and Receiving as it exists in V4.2.

In earlier versions of NET5, the overlap function was implemented at the card level; the card would pass a SETUP with all called digits after it received a message that included information indicating that receiving was complete. In this release, the host has control of digit collection and time-outs for both sending and receiving.

In Overlap Receiving, when a SETUP is received, it is passed to the host. The host responds with the SETUP ACK message. If all digits are not received, the network passes additional digits in INFORMATION messages and the host determines when all the digits have been received. When it is determined that all digits have been received, the host then sends the CALL PROCEEDING message.

In Overlap Sending, the host has control of digit assembly and transmission. When a SETUP is sent, it is passed to the destination. The destination responds with a SETUP\_ACK message, and the SDS/VCO enters the Outgoing Call Processing state.



### 1.8.1 Summary of Features

Generic support of ISDN Overlap Sending and Receiving includes the following:

- ON/OFF selection of Overlap Sending/Receiving feature via console
- SETUP and SETUP\_ACK support for Overlap Sending/Receiving
- Multiple INFORMATION message support for Overlap Sending/Receiving
- New ISDN state I\_OVRL support for Overlap Receiving and O\_OVRL for Overlap Sending
- Host timer expiry support for Overlap Receiving

### 1.8.2 Features Not Supported

- \$49 command with detach control for call clearing (aborting) on Overlap Receiving

### 1.8.3 User Interface—Overlap Receiving ON/OFF Control

The feature is configurable from the System Features screen. Selection of Enable NET5 Overlap Receiving enables both sending and receiving. See *Figure 1.7*.

When you enable the feature (set it to Y), the host has control of digit collection and time-outs, and acceptance of variable, unpredictable digit length is supported. The host also has control of digit assembly and time-outs, and transmission of variable, unpredictable digit length is supported. When the feature is disabled (set to N), the card hides the overlap function.

The initial default value of the Overlap Processing feature is N. When you change the value, the new value is saved in the database as the new default.

The feature change takes effect only when the NET5 card goes from out-of-service status to active status. Changing the feature value while a NET5 card is active has no effect. The feature flag is sent to the card.

S Y S T E M F E A T U R E S			
FEATURES	ALLOWED (Y,N)	FEATURES	ALLOWED (Y,N)
Redundant System	Y	Send All ISDN Connect Reports	N
Output Periodic Alarm Reports	N	Enable \$66 Cmd Host Checking	N
Card/Alarm Status at Init.	N	Cut Thru For Non-ISDN Alerting	N
Manual Intervention For SLIP/OOF	N	Enable 4th Column DTMF	N
Enable Grace Timing on Null Rule	N	Set MVDC-Backplane to A-Law	N
Disable Card Error Report/Reset	N	Enable AllPortsDeactivated Alm	N
Enable Digit Field Reporting	N	\$EA Reports on DChannel RESTART	N
Suppress PSC/Rule Abort Messages	Y	<b>Enable NET5 Overlap Receiving</b>	<b>Y</b>
Enable Host Password Check	N	Send All ISDN Disconnect Report	N
Force Bearer/Lap Activation	N		
Enable MFC-R2 Supervised Clear	N		
Enable SLIC Guarded Disconnect	N		
Enable CPA Monitor Disconnect	N		
Revert to Basic Redundancy	N		
Send Reports Before Guard Time	Y		
Enable ISDN Manual Disconnect	N		

Figure 1.7: System Features Screen with NET5 Overlap Receiving

### 1.8.3.1 Overlap Receiving Indication

The new Generic software introduces a new ISDN state of I\_OVRL (Incoming, OVerLap receiving) for a call.

According to the standard (European Telecommunications Standards Institute), an Overlap Receiving situation occurs when a received SETUP message contains one of the following:

- no called number IE
- an incomplete called number
- a called number which the user can't determine to be complete

Since the called number IE is *not* mandatory in SETUP, it is not feasible for the Generic to judge whether a "no called number IE" situation is actually an Overlap Receiving case or a normal case. Since Overlap Receiving operates in a situation where there is a variable digit length for a called number, even when some number(s) do appear in the called number IE, it is not possible for the Generic to determine if the called number is complete.

Only the Host Application can determine if information about the called number is complete, and that the call can be routed to its destination. The Generic depends on the Host Application for an indication of Overlap Receiving occurrence. To do this, the Host Application sends SETUP\_ACK down to the Generic through the \$49 command with an impulse rule specified. Under the impulse rule, a ISDN Tx template with SETUP\_ACK as the message, does the processing. IEs required by the SETUP\_ACK are either part of the ISDN template or attached to the \$49 command.

#### 1.8.4 Call State Transition

The Generic maintains two call states for a call: Major state and ISDN state. The ISDN state is affected when the Overlap Receiving feature is enabled.

For Overlap Receiving, a new intermediate state of I\_OVRL is introduced into the ISDN state. The state transitions occur as follows:

When a SETUP is received by the Generic,

```
Major state: CP_IDLE    --> CP_SETUP (unchanged)
ISDN state: ISDN_IDLE  --> I_CPRSNT (unchanged)
```

When an outgoing SETUP\_ACK is sent,

```
ISDN state: I_CPRSNT   --> I_OVRL
```

When the called number is complete and an outgoing CALL PROCEEDING is sent,

```
Major state: CP_SETUP  --> CP_WANS (unchanged)
ISDN state: I_OVRL     --> I_PRCEED
```

When CONNECT is sent and call goes to stable,

```
Major state: CP_WANS   --> CP_STAB (unchanged)
ISDN state: I_PRCEED   --> I_ACTIVE(unchanged)
```

For Overlap Sending, a new intermediate state of O\_OVRL is introduced into the ISDN state. The state transitions occur as follows:

When a SETUP is sent by the Generic,

```
Major state: CP_IDLE    --> CP_SETUP (unchanged)
ISDN state: ISDN_IDLE  --> O_INITED (unchanged)
```

When an outgoing SETUP\_ACK is sent,

ISDN state: O\_INITED --> **O\_OVRL**

When the called number is complete and an outgoing CALL PROCEEDING is received,

Major state: CP\_SETUP --> CP\_WANS (unchanged)

ISDN state: **O\_OVRL** --> O\_PRCEED

When CONNECT is received and call goes to stable,

Major state: CP\_WANS --> CP\_STAB (unchanged)

ISDN state: O\_PRCEED --> O\_ACTIVE(unchanged)

The supplemental state, displayed on the Port Display screen, is always 0 because it is not used for any ISDN PRI calls.

## 1.8.5 Call Establishment

The following describes the data flow of a call establishment with and without Overlap Receiving.

### 1.8.5.1 Overlap Receiving with Indication from Host Application

The host application checks the received SETUP message and judges that the called number is incomplete; at that point, Overlap Receiving occurs.

The host application then tells the Generic to send SETUP\_ACK to the PRI card.

The outgoing SETUP\_ACK serves as an indicator of Overlap Receiving to the Generic. I\_OVRL state is entered.

One or more INFORMATION messages are received and passed to the host application until the host application considers the called number to be complete.

The host application then sends CALL\_PROC out via the Generic.

The Generic considers this as an indicator of the end of Overlap Receiving; I\_PROCEED state is entered. Refer to *Figure 1.8*.

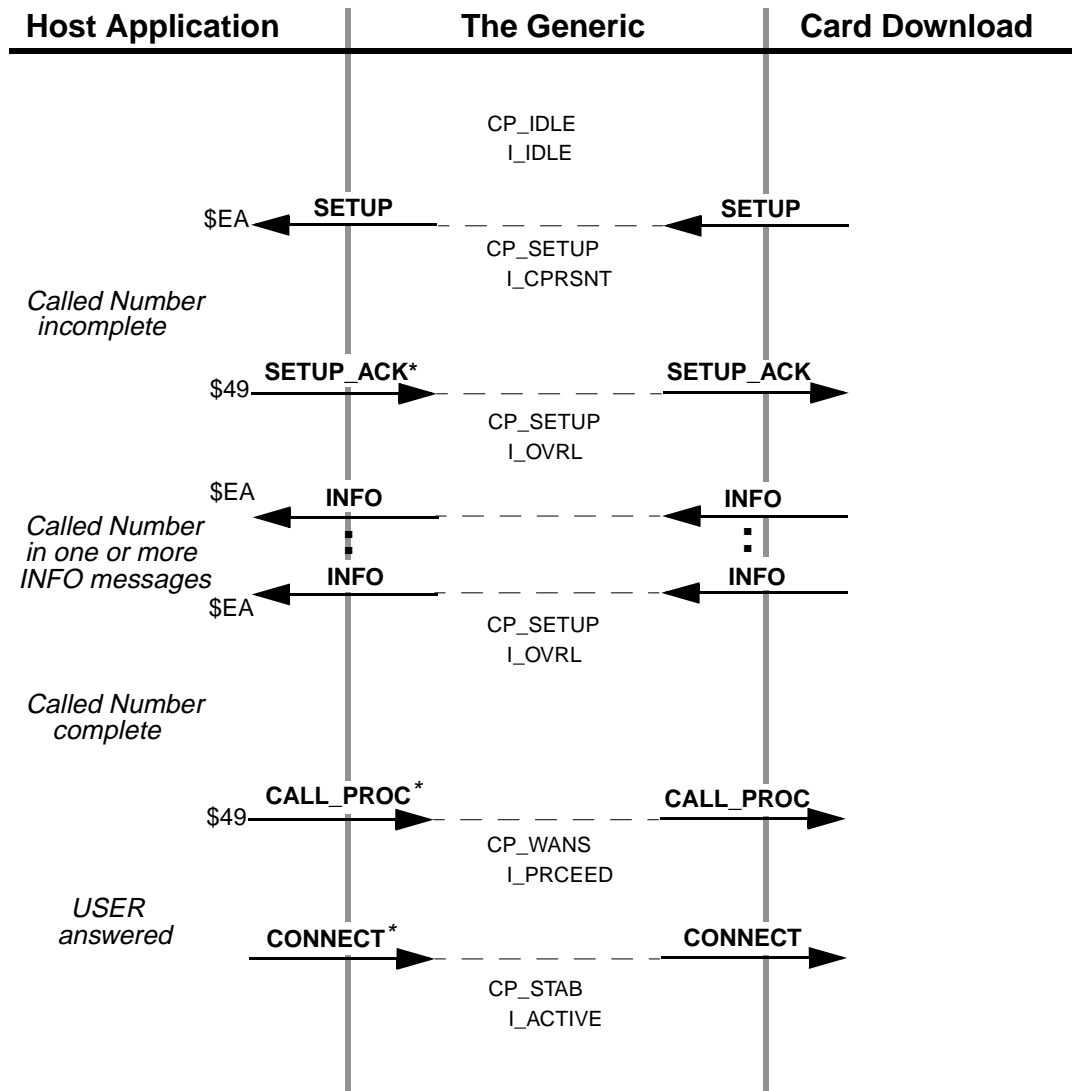

\* Messages are initiated by the Host Application but actually sent from the Generic

Figure 1.8: Overlap Receiving with Indication (SETUP\_ACK) from Host Application

Note that in *Figure 1.8*, the \$EA report, not the \$ED report, is sent to the Host Application for the SETUP message.

Also note that in those figures, the CONNECT message is sent from the Generic but initiated by the Host Application, and that the \$49 command is not necessarily the one that initiates the receiving.

### 1.8.5.2 Non-Overlap Receiving in Overlap Receiving Operation

It is possible and allowable in Overlap Receiving, for a SETUP message to already include the complete called number, and to not require further INFO messages.

In this case, the Generic does not enter I\_OVRL state even if the feature is enabled and SETUP is received. The indicator of Overlap Receiving is never sent from the host application to the Generic.

The host application checks and determines that the call can proceed and sends out CALL\_PROC right away.

### 1.8.5.3 Timer Expiry on Overlap Receiving

The system uses a timer (T302) when in Overlap Receiving to control call clearing (aborting). Refer to *Figure 1.9*. The timer resides in, and is controlled by, the card download.

If the host application determines that the called number is incomplete, it initiates SETUP\_ACK, Overlap Receiving begins, and the timer (T302) is started. The timer is restarted whenever an INFO message is received by the card download.

The timer is stopped when the card download receives CALL\_PROC from the Generic. This occurs when the host application determines that there is sufficient information about the Call Number, or when Receiving Complete Indication is received. At this point, the Overlap Receiving operation ends.

T302 expires in the Overlap Receiving operation if the card download does not receive CALL\_PROC within 10 to 15 seconds (the T302 value), and the host application determines that the called number is incomplete.

- Overlap Receiving operation is ended and the card download sends out DISC to the Network. At this point, there is no report of DISC from the card download to the Generic.
- The Network responds to DISC by sending back RELEASE, which is passed to the Generic and the host application.
- Call context at the Generic and the host application is cleared.
- The card download sends out REL\_COMPL to the network to complete the call clearing.
- The CAUSE IE with outgoing DISC for this call clearing is #28: Invalid Number Format (incomplete number).

*Figure 1.9* shows the T302 expiry and call clearing processing initiated by USER. The first call clearing message is RELEASE from NETWORK.

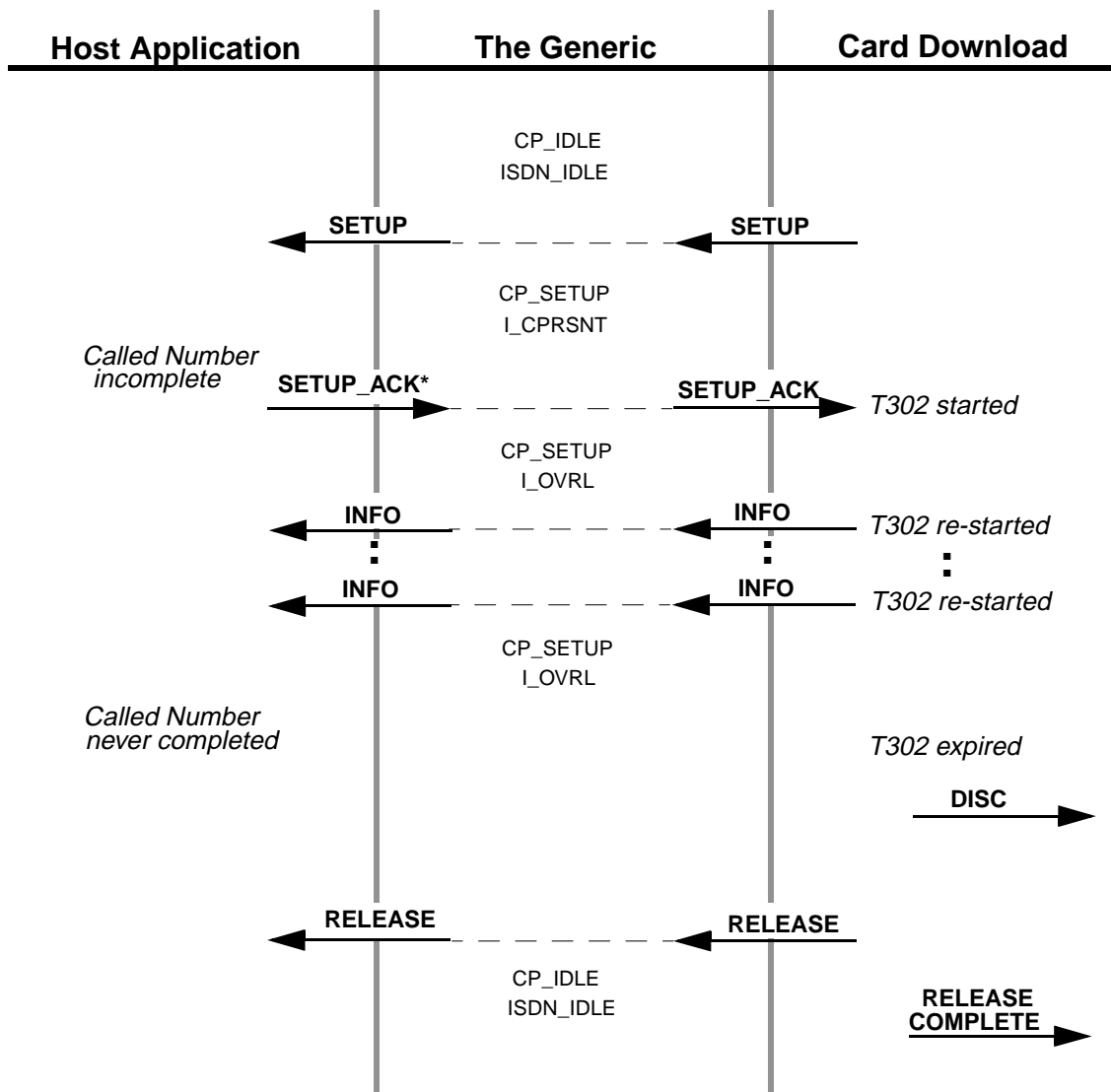

\* Messages are initiated by the Host Application but actually sent from the Generic

Figure 1.9: T302 Expiry and Call Clearing from the Card Download

#### 1.8.5.4 Overlap Sending with Indication from Host Application

The host application initiates the **SETUP** message and waits for the acknowledgment.

The incoming **SETUP\_ACK** serves as an indicator of Overlap Receiving to the Generic. **O\_OVRL** state is entered.

The host then transmits the Called Number in one or more **INFO** messages.

The host application considers the called number to be complete when a \$EA CALL\_PROC message is received.

The Generic considers this as an indicator of the end of Overlap Sending and O\_PROCEED state is entered. Refer to *Figure 1.10*.

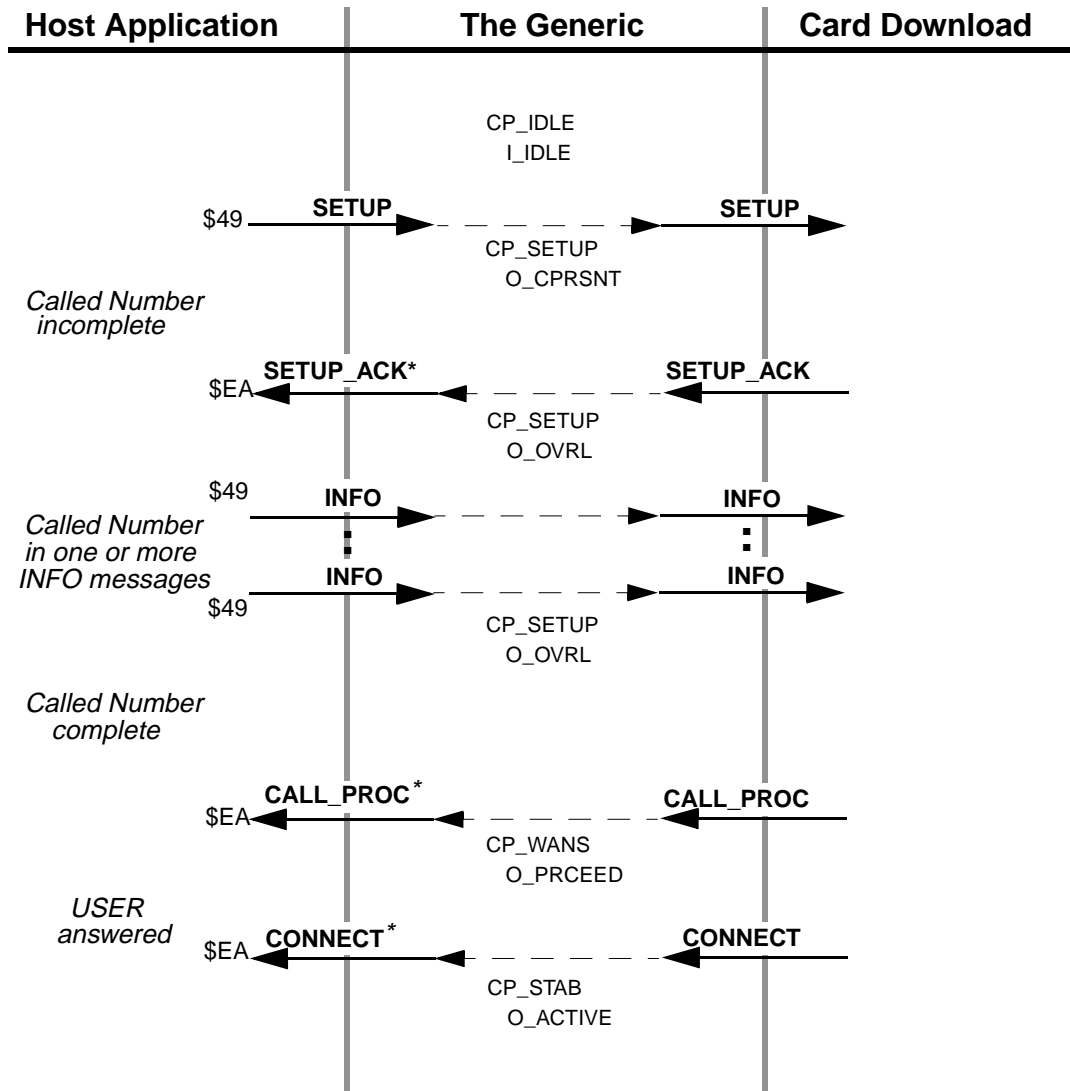

Figure 1.10: Overlap Sending with Indication (SETUP\_ACK) to Host Application



Note that in *Figure 1.10*, the \$49 report, not the \$ED report, is sent to the host application for the SETUP message.

Also note that in those figures, the CONNECT message is sent from the Generic but initiated by the host application, and that the \$EA command is not necessarily the one that initiates the sending.

## 1.9 JAPANESE ISDN ENHANCEMENTS

User-side Japanese ISDN support existed prior to this V4.2 FSR00 release. With this release, the protocol stack has been extended to accommodate the network side. These modifications have been made in response to the Nippon Telegraph and Telephone implementation of the ITU (CCITT) ISDN protocol in the Japanese domestic market. This is a simplification of the DSS 1 signaling implemented elsewhere.

A new feature flag has also been added to support Japanese ISDN operation.

### 1.9.1 Network-side Japanese ISDN

Network-side support is in addition to the existing user-side functionality. A single download file contains both access types. The user may select which is to be loaded onto the card.

Existing functionality common to both the user-side and network-side support:

- Message set support
- Information element set support

Functionality specific to network-side support:

- Modified user-side call states, timers, and event processing
- Outgoing RESTARTS
- Mandatory network timers—specifically timer T309

Functionality added to both user-side and network-side support:

- Network-side supplemental service—Advice Of Charge
- Network-side blocking channel ID

### 1.9.2 Disconnect Message Feature Flag

A feature flag controlling the return of \$45 disconnect messages has been added. This feature allows users to choose how ISDN disconnect reports are handled and is configurable from the System Features screen. Selection of Send All ISDN Disconnect Report enables the receipt of \$45 disconnect messages. See *Figure 1.11*.

When you enable the feature (set it to Y), the system functions properly with Japanese ISDN.

When the feature is disabled (set to N), disconnect report handling is consistent with Generic releases prior to V4.2 FSR00.

S Y S T E M F E A T U R E S			
FEATURES	ALLOWED (Y,N)	FEATURES	ALLOWED (Y,N)
Redundant System	Y	Send All ISDN Connect Reports	N
Output Periodic Alarm Reports	N	Enable \$66 Cmd Host Checking	N
Card/Alarm Status at Init.	N	Cut Thru For Non-ISDN Alerting	N
Manual Intervention For SLIP/OOF	N	Enable 4th Column DTMF	N
Enable Grace Timing on Null Rule	N	Set MVDC-Backplane to A-Law	N
Disable Card Error Report/Reset	N	Enable AllPortsDeactivated Alrm	N
Enable Digit Field Reporting	N	\$EA Reports on DChannel RESTART	N
Suppress PSC/Rule Abort Messages	Y	Enable NET5 Overlap Receiving	Y
Enable Host Password Check	N	<b>Send All ISDN Disconnect Report</b>	<b>N</b>
Force Bearer/Lap Activation	N		
Enable MFC-R2 Supervised Clear	N		
Enable SLIC Guarded Disconnect	N		
Enable CPA Monitor Disconnect	N		
Revert to Basic Redundancy	N		
Send Reports Before Guard Time	Y		
Enable ISDN Manual Disconnect	N		

Figure 1.11: System Features Screen with Send All ISDN Disconnect Report

## 1.10 CALL THROUGHPUT PERFORMANCE ENHANCEMENT

V4.2 FSR00 includes internal optimizations of the call processing software. These optimizations result in an improvement of about 12% in call throughput for typical customer applications compared to V4.0 FSR02 and earlier releases, although the improvement in throughput may vary depending on the application. The optimizations have no functional effect on switch operation other than the performance improvement.

## 1.11 LIVE UPGRADE

The Live Upgrade feature provides users with the ability to update software on a redundant SDS/VCO system without loss of calls, and with a minimum reduction in capacity. The process consists of converting the system controller to a new release, then switching over the port and service cards that need to be upgraded.

*Note: Live Upgrade must be installed on a switch before a Live Upgrade to a subsequent release can be performed. Because the Live Upgrade feature is included with V4.2 FSR00, it can be used to upgrade future versions of the Generic.*

Users can abort the process at any time and restore the prior version until the time when the active controller is running the new release of software. To revert to the prior release of software *after* the active controller is running the new software, the user must perform a non-live installation of the prior release.

*Note: Live Upgrade does not support SS7 upgrades. Following a Live Upgrade to the Generic, systems that are not configured to reset upon a system controller reset require manual reset of the Sparc. The SS7 system must also be configured to auto-start the SS7 software.*

### 1.11.1 Summary of Features

Live Upgrade contains the following features:

- Calls can be continued during the upgrade.
- The system administrator is prevented from modifying the configuration of the switch during the upgrade process.
- The installation routine checks the free space; if there is a shortage of space, it reports the problem to the user. The error messages and corrective action are explained in this document.
- Control of the upgrade may be done via:  
Local via serial port (Administration console)  
Telnet session (Ethernet)  
Modem port
- All log information about the live upgrade is sent to C:/LOG/UG*mmdyy*.LOG. This log is similar to the system log, but is written only during upgrade and reflects the upgrade in progress. Note that the filename contains the month, day and year of the update in the format *mmdyy*. The log file can be displayed and printed by choosing the Display/Print Upgrade Log menu option.
- The upgrade can be aborted up to the point where the Active CPU running the old version of the software switches control over to the Standby CPU running the new version of the software.
- New messages related to the live upgrade are noted in *Section 1.11.5*.

### 1.11.2 Overview of the Procedure

You can access the Live Upgrade Control Menu option from the Maintenance Menu. This is illustrated in *Figure 1.12*.

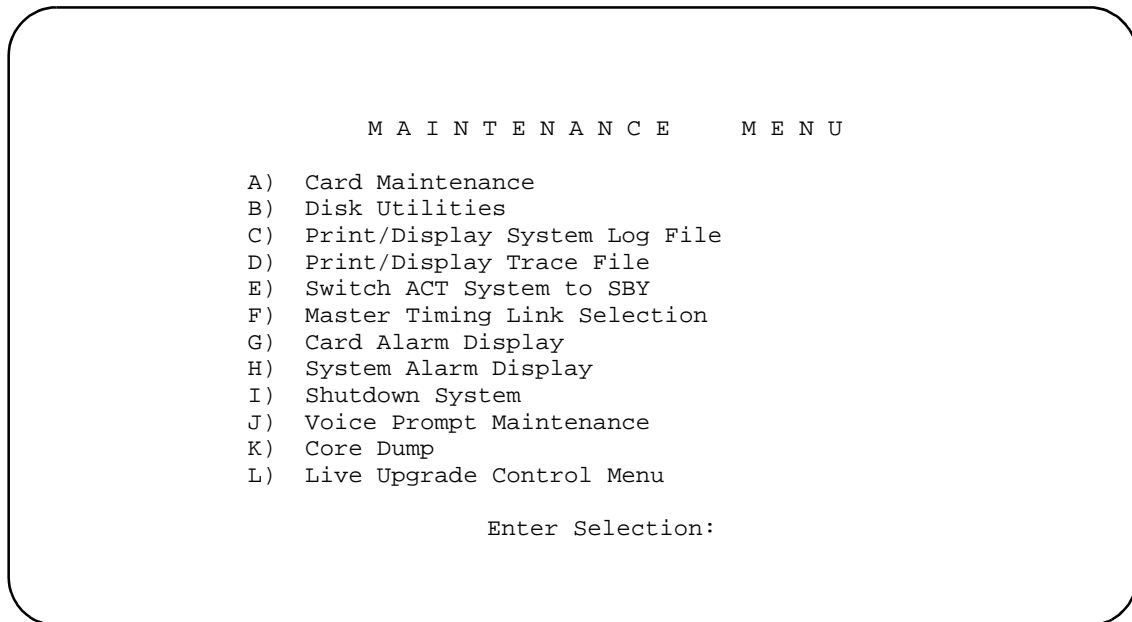

Figure 1.12: Live Upgrade on the Maintenance Menu

The Live Upgrade Control Menu is illustrated in *Figure 1.13*. Valid selections are limited to those appropriate for the current step.

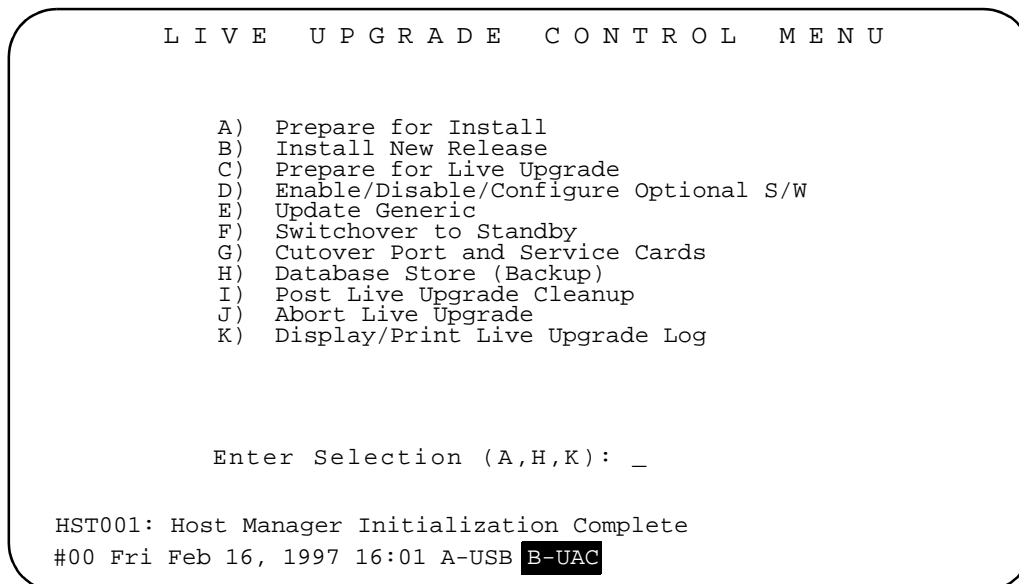

Figure 1.13: Live Upgrade Control Menu

Note that the redundant controller status field is different from previous releases. To indicate that a live upgrade is in progress, the field displays UAC or USB. UAC indicates UpgradeActive mode, and USB indicates UpgradeStandby mode. In *Figure 1.13*, side A is in standby mode and side B is active.

### 1.11.3 Overview of the Steps

An overview of the steps required to perform a live upgrade are listed below. A detailed description of the steps is included in the *System Administrator's Guide*.

Step	What to do—Live Upgrade menu option (note Figure 1.13)
1	Prepare for the installation of the new release—Option A Directories that are needed for the process are created. The current release on each side of system is backed-up.
2	Backup the existing database—Option H
3	Install the new software—Option B The needed files are placed on each controller of the switch.
4	Prepare for the upgrade—Option C The system is set up to boot from the new release. Suitability of system to accept the release is checked.
5	Enable/disable/configure optional software—Option D e.g. Ethernet, ISDN, NFAS, Telerouter
6	Update the generic—Option E The new release is booted on the standby side. A database conversion (if needed) is done. A synchronization of dynamic information is done.
7	Switch the active side to standby—Option F <i>The alternate side is updated.</i>  <i>Note: After this step is complete, the upgrade can no longer be aborted. Repeat steps 4-6 on the standby controller.</i>
8	Cutover of Port and Service Cards—Option G The port and service cards are switched-over.
9	Backup the new database—Option H
10	Clean-up—Option I

The upgrade process is illustrated in *Figure 1.14*. Note in the illustration that the A-side is initially in standby mode. The A-side controller is upgraded with the new generic software and rebooted. After rebooting, a switchover is performed, making the A-side and the new software active. This procedure allows the system to maintain live traffic while being upgraded and switched to the new software.

*Note: If the B-side is in standby mode, the B-side would be upgraded and rebooted first.*

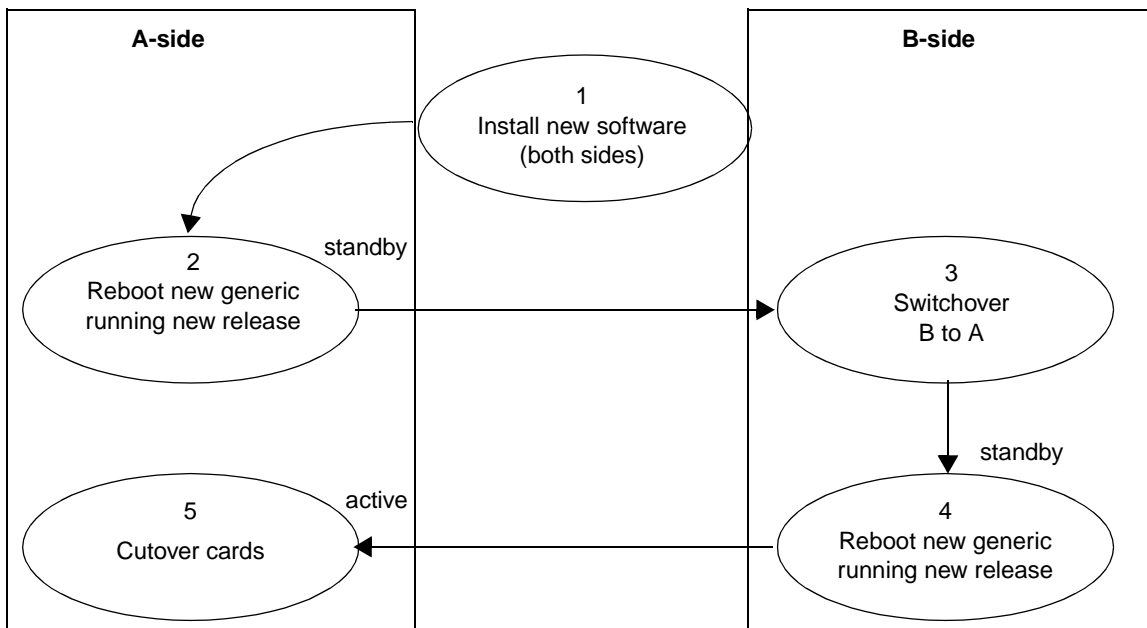

Figure 1.14: Overview of the Upgrade Process

The live upgrade steps are logged in the log upgrade log file, *C:/log/UGmmddy*, where *mmddy* is the month, day, and year that the upgrade was done.

#### 1.11.4 Host Commands and Reports

The `$C0 01` command is used to control switchover of the VCO system from the active side to the standby side. During Live Upgrade, a host-initiated switchover is not allowed. The network status byte (NSB) of `$5E` is returned to indicate that a host-initiated switchover request was denied due to a Live Upgrade in progress.

### 1.11.5 Prompts, Warnings and Error Messages

The following are the new messages associated with the live upgrade feature.

#### 1.11.5.1 Prepare for Install Messages

The following messages may be displayed during the Prepare for Install step of the Live Upgrade process.

Creating Directory Structure on Device C:

This indicates that the temporary directory structure required for the upgrade is being created.

Directory Structure Created

This indicates that the temporary directory structure has been created.

BOOT and DBASE Files Saved

This indicates that the files from the /BOOT and /DBASE directories have been copied to the temporary directories. The files are maintained there during the upgrade in case it is necessary to abort the upgrade and restore the original software.

#### 1.11.5.2 Installing New Software Messages

The following is a list of messages that may be displayed during the Installing New Software step of the Live Upgrade process.

Installing from Generic Diskette #

The files from the specified diskette are being installed.

Copying File *filename*

A specific file is being copied to the hard disk.

File not found *filename*

The generic software expected a file to be present on the diskette during the install process. Instead, the file was not found. An abort of the upgrade will follow.

*Note: This message may appear if there is insufficient space on the hard disk.*

All Files from Floppy Copied

This indicates that all files were successfully copied from the diskette.

Installing from *Optional Software* Diskette

This indicates that the files from the optional software diskette are being installed.

Copying Optional Software Failed

This indicates that the installation of the optional software package failed.

Invalid Optional Software Floppy

This indicates that the diskette does not represent a valid software option.

### 1.11.5.3 Prepare for Upgrade Messages

The following is a list of messages that may be displayed during the Prepare for Upgrade step of the Live Upgrade process. An index of critical upgrade information (CUI) is generated during the Prepare for Upgrade step and recorded in the upgrade log. The critical upgrade information messages are described below.

#### All Files Present

This indicates that the check of required files was successful.

#### Check For All Files FAILED

This indicates that the check of required files failed. An abort of the upgrade process will follow.

#### Copying New Files

This indicates that the newly installed software is being copied from the temporary directories into the system /BOOT and /DBASE directories.

#### Copied New Files

This indicates that the copy of the newly installed software to the system /BOOT and /DBASE directories is complete.

#### Getting Single Resource Information

This indicates that the generic is reviewing the current database configuration for information which may impact uninterrupted service provided by single resources.

#### Existing Version of *filename.tbl* is a.b.c. New Version is x.y.z.

This indicates that the existing version of the specified database table is later than the newly installed version. This does not represent a valid upgrade. An abort of the upgrade will follow.

#### Cannot Upgrade to Lower Version. Aborting

This indicates that the administrator has installed a version of software which is earlier than the existing software. This does not represent a valid upgrade. An abort of the upgrade will follow.

#### CUI#: Firmware Incompatible, Upgrade Required for *cardtype* at X,X,XX

This indicates that the firmware presently installed on the specified card is not compatible with the newly installed software. It will be necessary for the administrator to upgrade the firmware during the Card Cutover step. The administrator should verify that the current version of firmware is available and that the loss of this resource during cutover will not impact service significantly.

#### CUI#: Firmware Compatible, Upgrade Recommended for *cardtype* at X,X,XX

This indicates that the firmware presently installed on the specified card is compatible with the newly installed software, though it is not the current version. It is recommended that the administrator upgrade the firmware during the Card Cutover step. The administrator should verify that the current version of firmware is available and that the loss of this resource during cutover will not impact service significantly.

#### CUI#: Redundant BRC pair does not exist, active pair requires upgrade!!

This indicates that the BRC requires an upgrade and a redundant BRC pair does not exist in the database. The process of upgrading the BRC pair will result in the loss of all resources in the subrack supported by the BRC pair. The administrator should verify that the loss of this subrack during cutover will not impact service significantly.



CUI#: *cardtype* at X,X,XX is the Last/Only Active Card of Resource Group #

CUI#: *cardtype* at X,X,XX, Limbo Card of NFAS Group # Requires Upgrade

CUI#: *cardtype* at X,X,XX, Last Resource of B Chnls of NFAS Group # for Upgrade

These messages indicate that the specified card types require upgrade, though the loss of these resources impact the groups with which they are associated.

CUI#: NBC3/DTG2 at X,X,XX Upgrade Required During Update Generic Step

This indicates that the NBC3/DTG2 upgrade(s) required cannot be done during the Card Cutover step. These cards must be upgraded during the Update Generic step of the Live Upgrade process.

CUI#: Critical Upgrade Information Present in Upgrade Log

This indicates that one or more critical upgrade information messages appear in the upgrade log. The administrator should review these before continuing with the upgrade.

#### 1.11.5.4 Enable/Disable/Configure Optional Software Messages

The following is a list of messages that may be displayed when in the Enable/Disable/Configure Optional Software screen.

Optional Software Not Installed

This indicates that no software options were installed. There is nothing to enable, disable, or configure.

Optional Software Configure, Complete

This indicates that the configuration of software options is complete. This message is generated when the administrator leaves the Enable/Disable/Configure Optional Software screen.

*SOFTWARE OPTION* Enabled

This indicates that the specified software option was enabled in the Enable/Disable/Configure Optional Software screen. This message is also printed in the upgrade log to provide a record of the configuration of the software option.

*SOFTWARE OPTION* Disabled

This indicates that the specified software option was disabled in the Enable/Disable/Configure Optional Software screen. This message is also printed in the upgrade log to provide a record of the configuration of the software option.

ENTER To Confirm Disable

This prompts the user to confirm that the software option should be disabled.

*Note: If accessing the switch via Ethernet, disabling the Ethernet optional software will prevent you from accessing the switch after the Update Generic step.*

#### 1.11.5.5 Card Cut-Over Messages

The following is a list of messages that may be displayed when in the Card Cut-Over screen.

Invalid Operation. Must be (A, G, or F)

The user entered an invalid option. Only A, G or F can be entered in the command field.

Card Does Not Require Upgrade

This message is displayed if the user entered a card location other than one from the list. Re-enter a card location from the displayed list, in accordance with the system convention for identifying rack, level, slot, and interface.

**RLSI X,X,XX Being Forced OOS**

This message appears after the user has entered the F command to force the card OOS. The system forces the card specified by the rack, level, slot and interface, out-of-service (OOS).

**RLSI X,X,XX Being Gracefully Idled**

This indicates that the user has entered the G command to gracefully idle the card. The system gracefully takes the card specified by the rack, level, slot and interface, out-of-service (OOS).

**RLSI X,X,XX Is Now OOS**

This indicates that the card, indicated by rack, level, slot and interface has become out-of-service (OOS).

**RLSI X,X,XX Is Now Active**

This indicates that the card indicated by rack, level, slot and interface has become active.

**Taking Active BRC OOS, Continue?**

This warns the user that a BRC card to be taken out-of-service (OOS), will cause a BRC switchover. The user can press the Enter key to continue or any other key to abort.

**Last Active Card of ResGrp #! Continue?**

**Limbo Card of NFAS Group #!, Continue?**

**Last B chnls of NFAS Grp #!, Continue?**

The user is taking the last card of the specified group out-of-service (OOS) as the result of a G or F command. The user can press the Enter key to continue or any other key to abort.

**Active DTG, Will Lose Tones! Continue?**

The user is taking the active DTG card out-of-service (OOS) as the result of a G or F command. If a standby DTG/DTG-2 is present, a DTG switchover will occur. Otherwise, the switch will be without tone generation and outpulsing during the DTG upgrade. The user can press the Enter key to continue or any other key to abort.

*Note: This applies only to DTG cards. This does not apply to DTG-2 cards.*

**Card Already OOS**

The user tried to change the status of the card to OOS when the card was already out-of-service (OOS).

**Not Allowed!! Card Gracefully Idling**

The user tried to change the status of the card to OOS when the card was gracefully idling.

**NBC3/DTG2 Cutover Not Allowed**

The user selected an NBC3/DTG2 card for cutover. The NBC3/DTG2 card upgrade must be performed during the Update Generic step.

**No Cards Require Cutover**

This user selected the Card Cutover screen, however no cards require cutover.

### 1.11.5.6 General Live Upgrade Messages

The following is a list of other messages that may be displayed during the Live Upgrade process.

#### Invalid Option

The user selected an option from the Live Upgrade Control Menu which is not valid.

#### Live Upgrade Aborting...

The Live Upgrade process has initiated an abort sequence. The abort sequence is initiated by the user or initiated automatically when a configuration issue has been identified.

#### Restored Original C:/BOOT and C:/DBASE files

This indicates that the original /BOOT and /DBASE files have been restored from the temporary directories as part of the abort sequence.

#### Live Upgrade Aborted...

This indicates that the abort sequence has completed.

#### Operation Not Allowed During Upgrade

This indicates that the requested operation cannot be performed while the switch is undergoing a live upgrade.

#### Waiting for Stable State

This indicates that the switch is preparing itself for a reset of the standby controller. Upon reboot of this controller, the newly installed generic software will be running.

#### Resetting System ...

This indicates that switch has prepared itself for the reset of the standby controller and the reboot will follow shortly.

#### Switchover Not Allowed During Upgrade

The user has requested a manual switchover from the Maintenance Menu during a live upgrade. This is not allowed during the live upgrade process.

## 1.12 REMOTE FILE TRANSFER (FTP)

The Remote File Transfer feature facilitates the transfer of files between a remote site and the VCO system. The feature is required to perform remote file manipulation during remote diagnostics, upgrades, and maintenance. It also provides the user with the ability to retrieve directory listings and manipulate the directory structure by renaming, and/or removing files on the remote system.

### 1.12.1 Summary of Features

The functionality allows you to:

- Download files from VCO to the remote host site over Ethernet
- Upload files from the remote host site to VCO over Ethernet
- Retrieve listings of directories and files within directories
- Delete files
- Create directories
- Delete directories

- Rename files
- Rename directories
- Change current working directory
- Show current working directory
- Transfer files in both ASCII and binary mode
- Configure user name/password screen for restricted access to the system
- Compress and uncompress files on the SDS/VCO
- Split and join files on the SDS/VCO

### 1.12.2 FTP Transfer of Files

The Remote File Transfer process is based on standard FTP which involves two connections between a remote site and the SDS/VCO. One connection is for the transfer of commands and reports, and the other for the transfer of data (i.e., file data transfer, directory listing transfer).

The following limitations apply:

- The data connection uses a specific address and is opened dynamically as required, then closed after the transfer of data. The networking software in use has a limitation: an address, once used, cannot be used again for approximately two minutes. Therefore, it is strongly recommended that for successful transfer of data, an approximate two minute interval be scheduled between successive file transfers.  
*Note: Due to this limitation, do not try to transfer files with wildcards, as it would open data transfer connections in rapid succession.*
- A binary file should be transferred in binary mode only.
- The current implementation of FTP restricts access to the C: drive only, on the VCO system.
- In accordance with the DOS file system, limit the file and directory names to eleven characters as follows: eight characters for the primary name and three characters for the extension. If these limits are exceeded when transferring from the remote site to the VCO, the file transfer will not succeed; an unsuccessful file creation error occurs on the VCO.

FTP is a TCP/IP or Internet tool and requires implementation on the remote site.

### 1.12.3 FTP Password Configuration Screen

The FTP Password Configuration screen was added for FTP password entry. Access this screen from the System Configuration menu with the new Option L. Refer to *Figure 1.15*.

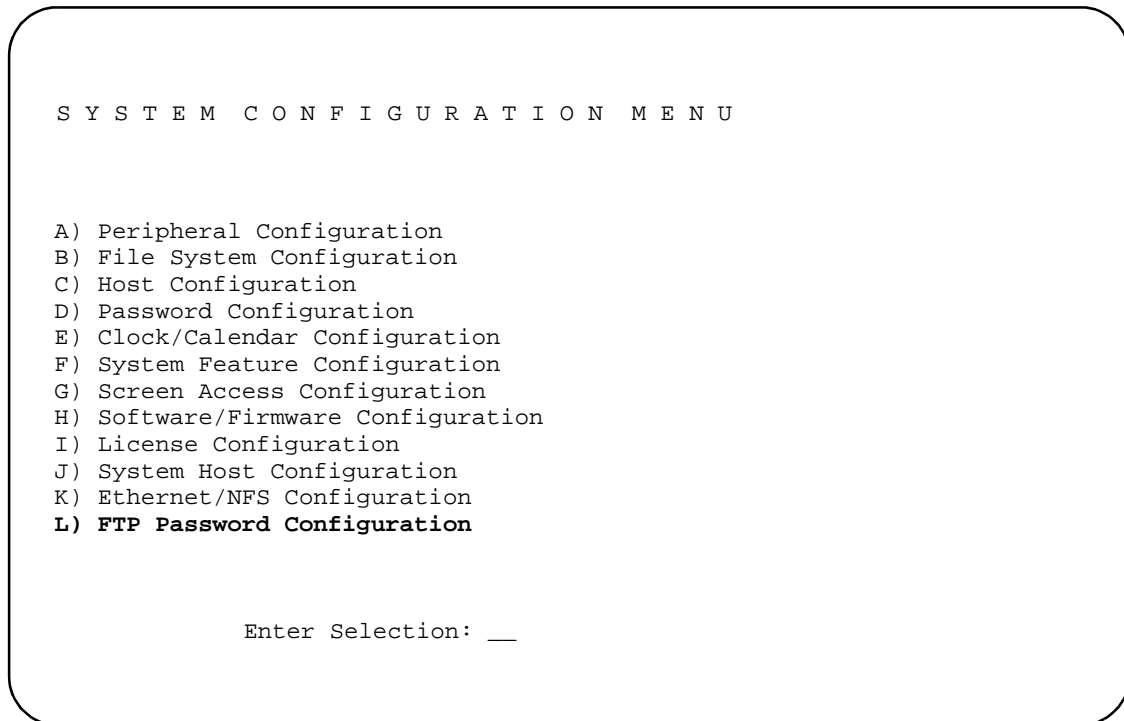

Figure 1.15: FTP Password Configuration Screen Access from the System Configuration Screen  
Refer to *Figure 1.16*. Users who are added to the database via the FTP Password Configuration screen are allowed access to the SDS/VCO through FTP.

*Note: A database conversion is required when updating to this software version.  
Refer to Section 3 for information about updating your system to V4.2.*

```
      F T P      P A S S W O R D      C O N F I G U R A T I O N
Username      Access Level      Username      Access Level

Add/Del/Change:      (A/D/C Only)
Username:
Current Password:
New Password:
Verify Password:
Access Level:

#00 Fri Mar 21, 1997 15:05 A-ACT B-SBY
```

Figure 1.16: FTP Password Configuration Screen

The FTP Password Configuration screen fields are the same as those in the Generic Password Configuration screen. The FTP passwords, however, are completely independent of the generic passwords and user names. Refer to the *System Administrator's Guide* about the Password Configuration screen for detailed information about the fields.

#### 1.12.4 New Disk Utilities Options

There are several new Disk Utilities options necessitated by Core Dump and the Remote File Transfer. The new options are:

- Compress File
- Uncompress File
- Split File
- Join File
- Create System Configuration File

Execute these options through the installation Disk Utilities menu or the administrative console Disk Utilities menu. Refer to *Figure 1.17* and *Figure 1.18* for illustrations of the new Disk Utilities screens and prompts.

You can also execute these options when in FTP with the quote command. Refer to *Section 1.12.7* for additional information.

The options are explained in the following sub-sections.

### Compress File

Use the Compress File option to decrease the size of a file, without losing information. You may want to compress a file to facilitate a file's transfer or when copying to another device. Refer to *Section 1.12.5* for the prompts and user input for this feature.

Note the following when compressing a file:

- When a file is compressed, the filename is the same as the original file with the extension *.Z*.
- The name of the file to be compressed *cannot* contain a file extension.

Any file compressed on the SDS/VCO can be uncompressed on a UNIX workstation or any other computer, with a utility called *uncompress*, which is based on the BSD 4.2 UNIX implementation.

### Uncompress File

Use the Uncompress File option to expand a compressed file to its original size and content. Refer to the previous section, *Compress File*, for information on compressing files. Refer to *Section 1.12.5* for the prompts and user input for this feature.

Any file compressed on the SDS/VCO, a UNIX workstation, or other computer, with a utility called *uncompress* based on the BSD 4.2 UNIX implementation, can be uncompressed on the SDS/VCO. The file to be uncompressed *must* have a *.Z* filename extension. When a file is uncompressed, the filename is the same as the compressed filename but without the *.Z* extension. You can rename the file with a new extension if desired.

### Split File

Use the Split File option to split a large file into a series of smaller files. This may be required if you need to copy a large file onto a floppy disk. Refer to *Section 1.12.5* for the prompts and user input for this feature.

All files accessible to the SDS/VCO can be split into a series of smaller files. The algorithm used requires an output filename and the number of bytes for each segmented file. The split operation then produces the required number of file parts, each a segment of the original file. The sum of the files produced from the split comprises the total size of the original file.

The output of the Split File operation results in a series of files with the designated output filename, and an extension as shown below.

```
filename.xaa  
filename.xab  
filename.xac  
filename.xad
```

The file extensions increment in alphabetic order as necessary to accommodate the full contents of the original file. There is a maximum of 512 files that may result through the split operation. This should be taken into consideration when indicating the split file size.

### Join Files

Use the Join File option to re-assemble split files back into the original file. Refer to the previous section, *Split File*, for information on splitting files. Refer to *Section 1.12.5* for the prompts and user input for this feature.

The Join File operation requires two inputs from the user: the destination filename and the source filenames. If the destination filename exists, the source files are appended to it.

- The destination file is the file defined to be the composite of all the split files. After joining all file segments, the destination file will be identical to the original file before the split process occurred.
- The source file is the file or files that will comprise the new (destination) file. These are the file segments that resulted from the Split File operation.

The join operation supports alphabetically-ordered wildcard symbols. Therefore, you can specify a unique destination filename, and the source filename, with wildcard characters in the file's extension. For example, if the split (or source) files are:

```
filename.xaa  
filename.xab  
filename.xac  
filename.xad
```

You can specify the source file with wildcard characters—for example, filename.x?? You can also specify the source file by filename with no extension.

The filename.x?? source file designation results in all the split files, or file segments, with a three-character extension beginning with the letter x, being joined at once. The joining automatically appends the split files in alphabetic order to the destination file.

*Note: The question mark (?) wildcard is a single character wildcard. The asterisk (\*) wildcard is a multi-character wildcard.*

If the filename is designated without an extension, all files with that filename are joined. The order is based on the alpha character ordering of the extensions.

You may initiate the join operation for each split file, but you must do so in alphabetic order by filename.



### 1.12.5 New Installation Disk Utilities Menu

The new installation Disk Utilities menu is shown in *Figure 1.17*. Note the new options for FTP support, 10 through 13.

```
          D I S K   U T I L I T I E S

1) Show Directory
2) Copy Files
3) Delete Files
4) Rename Files
5) Show Free Space on Disk
6) Format Disk
7) Create Directory
8) Delete Directory
9) Rename Directory
10) Compress File
11) Uncompress File
12) Split File
13) Join Files
14) Create System Configuration File
15) Exit Disk Utilities

Enter Selection _
```

Figure 1.17: The Installation Disk Utilities Menu

The system prompts and user responses noted in the following explanations are displayed at the bottom of the Disk Utilities screen. The screen scrolls up as the information is displayed.

#### Option 10 — Compress File

The name of the file to be compressed *cannot* contain a file extension. If you are compressing the core.1 file, rename the file and designate a filename with no extension. For example, you can rename the file to core1.

If you select option 10, Compress File, you are prompted to supply necessary information:

Enter file to be compressed:

Enter the drive and filename of the file to be compressed. For example:

Enter file to be compressed: C:core1

The system responds with file compressed when the compress file operation is successfully completed. In the example above, the filename of the compressed file would be core1.z

### Option 11 — Uncompress File

If you select option 11, Uncompress File, you are prompted to supply necessary information:

Enter file to be uncompressed:

Enter the drive and filename of the file to be uncompressed. For example:

Enter file to be uncompressed: C:core1

*Note: The filename can be entered with or without the .Z extension. The software assumes the .Z extension if the filename is entered without an extension.*

The system responds with file uncompressed when the uncompress file operation is successfully completed. The filename of the compressed file is the same as the compressed filename but without the .Z extension. Using the example above, the uncompressed filename would be core1.

### Option 12 — Split File

If you select option 12, Split File, you are prompted to supply necessary information:

Enter file to be split:

Enter split file size:

Enter the drive and filename of the file to be split and the size (number of bytes) of each of the split, file segments. For example:

Enter file to be split: C:core1

Enter split file size: 1440000

*Note: The recommended split size for floppy disks is 1,440,000 bytes.*

The system responds with file split when the split file operation is successfully completed. The resulting file segments would each be 1,440,000 bytes, noting that the last file segment may be less than the indicated size. The total of the file segments in bytes equals the original file size.

For example, if the original core1 file to be split is 8.4 Mb, the resulting split filenames and sizes are shown below.

core1.xaa	1440000
core1.xab	1440000
core1.xac	1440000
core1.acd	1440000
core1.xae	1440000
core1.xaf	1200000

The total of all split files, core.xaa through core.xaf, is 8.4 Mb, the size of the original core file.

### Option 13 — Join Files

If you select option 13, Join File, you are prompted to supply necessary information:

Enter file to join from:

Enter file to join to:

Enter the drive and filename of the files to be joined, and the drive and name of the new, joined file.

For example, assuming that the files in the previous section (refer to *Option 12 — Split File*) were to be joined into a new file named joinfile, you could include the wildcard character and supply the following information:

Enter file to join from: C:core1.x??

Enter file to join to: C:joinfile

The system responds with files joined when the join file operation is successfully completed.

*Note: If you do not specify a file extension, the join operation joins **all** files with the filename you specified. In the above example, if you input C:core1 in response to the prompt: Enter file to join from:, all files with the filename core1 would be joined together in a new file named joinfile.*

Refer to Join Files in *Section 1.12.4* for additional information on specifying the filename of the files to be joined.

### 1.12.6 New Administrative Console Disk Utilities Menu

The new administrative console Disk Utilities Menu is shown in *Figure 1.18*. Note the new options, M through P.

```
          D I S K       U T I L I T I E S   M E N U

A) Show Directory           M) Compress File
B) Copy Files              N) Uncompress File
C) Delete Files            O) Split File
D) Rename Files           P) Join Files
E) Database Store
F) Database Retrieve
G) Display File
H) Show Free Space on Disk
I) Format Disk
J) Create Directory
K) Delete Directory
L) Rename Directory

      Enter Selection:

#00 Fri Mar 21, 1997 15:05 A-ACT B-SBY
```

Figure 1.18: The Administrative Console Disk Utilites Menu

### Option M — Compress File

If you select option M, Compress File, the following sub-menu appears, prompting you to supply necessary information.

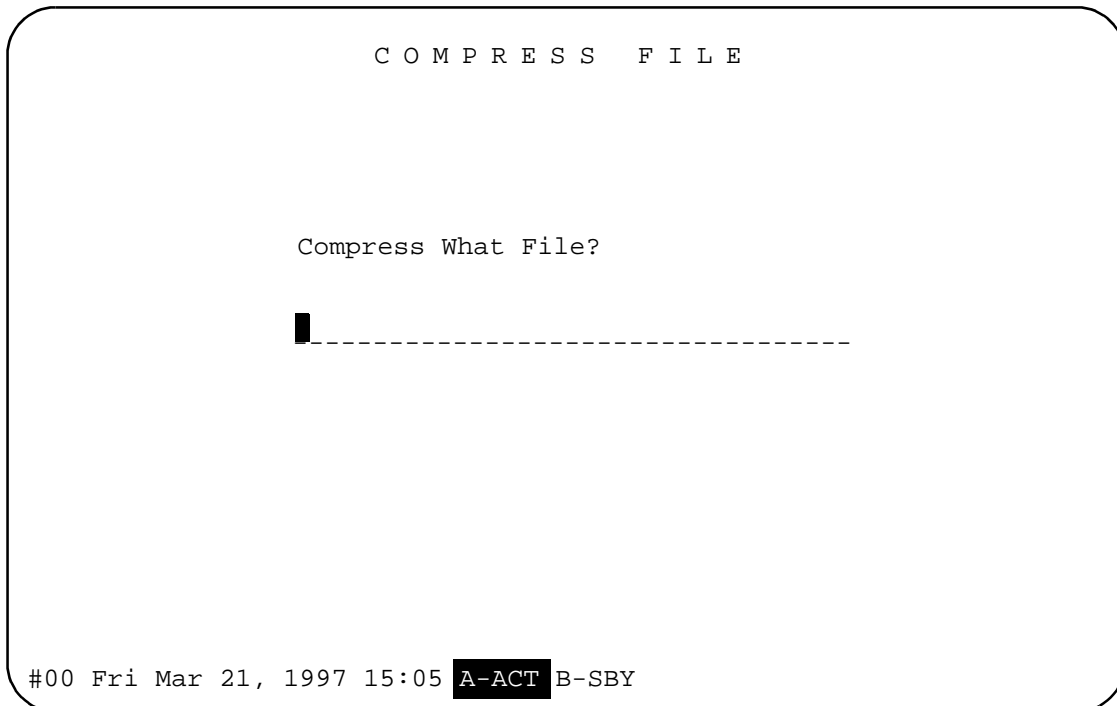

Enter the drive and filename of the file to be compressed on the blank line. Note that the prompt is positioned at the beginning of the blank line. Press the **Enter** key when you are done entering the information.

Refer to *Section 1.12.5, Option 10 — Compress File* for information on supplying the necessary information.

### Option N — Uncompress File

If you select option N, Uncompress File, the following sub-menu appears, prompting you to supply necessary information.

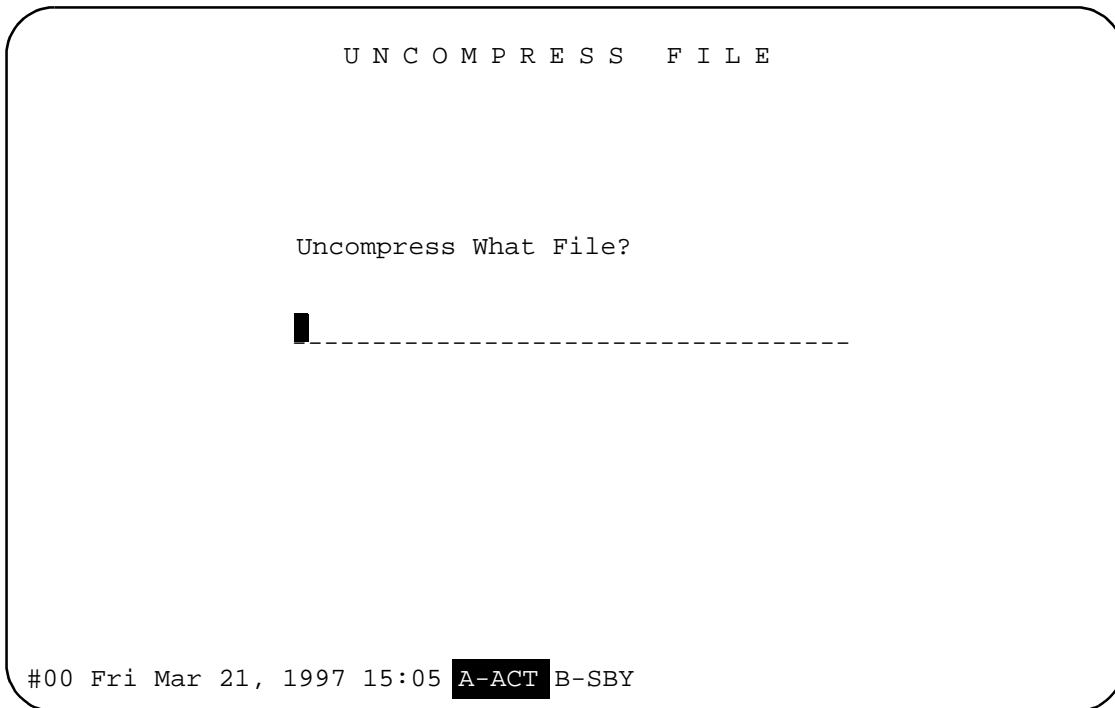

Enter the drive and filename of the file to be uncompressed on the blank line. Note that the prompt is positioned at the beginning of the blank line. Press the **Enter** key when you are done entering the information.

Refer to *Section 1.12.5, Option 11 — Uncompress File* for information on supplying the necessary information.

### Option O — Split File

If you select option O, Split File, the following sub-menu appears, prompting you to supply necessary information.

```
          S P L I T   F I L E

Split What File?
█-----

Split File Size:
-----

#00 Fri Mar 21, 1997 15:05 A-ACT B-SBY
```

Enter the drive and filename of the file to be split on the first blank line. Note that the prompt is positioned at the beginning of the blank line. Press the **Next Field** key to go to the second blank line and enter the size of the split file segments. Press the **Enter** key when you are done entering the information.

Refer to *Section 1.12.5, Option 12 — Split File* for information on supplying the necessary information.

### Option P— Join Files

If you select option P, Join Files, the following sub-menu appears, prompting you to supply the necessary information.

```

                                J O I N   F I L E

Join From?
█-----
Join To?
-----

#00 Fri Mar 21, 1997 15:05 A-ACT B-SBY
```

Enter the drive and filename to be joined on the first blank line. Note that the prompt is positioned at the beginning of the blank line. Only one filename can be specified; however, wildcard characters can be used to join several files at a time. Press the **Next Field** key to go to the second blank line and enter the name of the new, joined file. Press the **Enter** key when you are done entering the information.

Refer to *Section 1.12.5, Option 12 — Split File* and *Option 13 — Join Files* for information on supplying the necessary information.

### 1.12.7 FTP Functions

You can access the new options described in the Disk Utilities menu through FTP. Refer to *Section 1.12.4* for information about the options and *Section 1.12.5* for additional information about the results of executing the options. Refer to *Section 1.12.8* for information about accessing the SDS/VCO through FTP.

The examples used here are the same as those used in *Section 1.12.5*.



To execute the new Disk Utilities options in FTP, use the quote command at the FTP prompt. The quote commands and syntax follows.

*Note: The quote command is case sensitive; it must be typed in lowercase. The new Disk Utilities option commands, compress, uncompress, split, and join, are not case sensitive, they may be typed in uppercase or lowercase.*

### Compress File

To compress a file, type:

```
quote compress filename
```

Where *filename* is the name of the file to be compressed. For example:

```
quote compress c:core1
```

*Note: The name of the file to be compressed cannot contain a file extension.*

### Uncompress File

To uncompress a file, type:

```
quote uncompress filename
```

Where *filename* is the name of the file to be uncompressed. For example:

```
quote uncompress c:core1
```

### Split File

To split a file, type:

```
quote split filename file_size
```

Where *filename* is the name of the file to be split, and *file\_size* is the desired size (in bytes) of the file segments. For example:

```
quote split c:core1 1440000
```

*Note: The recommended split size for floppy disks is 1,400,000 bytes.*

### Join File

To join a file, type:

```
quote join destination_filename source_filename
```

Where *destination\_filename* is the name of the file that is to contain all the file segments to be joined, and *source\_filename* is the file segment(s) to be joined or appended to the *destination\_filename*. For example:

```
quote join c:joinfile core1.x??
```

This command joins all files named *core* with an extension beginning with *x* followed by any two characters, to a file named *joinfile*. It joins multiple files because of the *?* wildcard.

The following command appends *all* files with the filename core1 to the file named joinfile:

```
quote join c:joinfile core1
```

The following command appends *only* the file named core1.xaa to the file named joinfile:

```
quote join c:joinfile core1.xaa
```

If there are additional file segments to be added to the joinfile file, you must use the above syntax to append each one. The files must be appended in alphabetical order. For example, the next command would be:

```
quote join c:joinfile core1.xab.
```

If this command was issued after the quote join c:joinfile core1.xaa command, the file named core1.xab would be added to the file named joinfile after the contents of the file core1.xaa.

*Note: If you append one file at a time, you must append the files in order.*

### 1.12.8 Accessing the SDS/VCO via FTP

Use the following procedure to access the SDS/VCO through FTP.

1. Configure the SDS/VCO system for access.  
Add the users who will be allowed access to the SDS/VCO through FTP. Use the FTP Password Configuration screen to add users (*Section 1.12.3*).
2. Invoke FTP from the FTP workstation.  
Type ftp hostname, where hostname is the IP address of the SDS/VCO. If the connection is successful, you are prompted for a username at the FTP prompt.
3. Login to the SDS/VCO  
Enter a valid username. If the username is valid, the system prompts you for the password. Enter your password. If you enter an invalid username or password, the system returns the message: Login failed.

*Note: Only one user can access the system through FTP at a time. If a user is already logged-in to the system, any subsequent login does not proceed until the current FTP user exits. Then the login procedure continues.*

#### FTP Commands

After you connect and login to the SDS/VCO system, you can create or remove directories, rename or delete files, or move files between the remote host and the SDS/VCO. Examples of valid FTP commands are given in the procedures outlined in the following subsections.

*Note: Although FTP supports a variety of other commands besides those described here, only the commands listed here are guaranteed. In the case of a malfunction due to your issuing another random command, quit the application and login again.*

## Transferring Files via FTP

To transfer files between the remote host and the SDS/VCO, note the following.

### Setting the mode for file transfer

After logging-on (refer to *Section 1.12.8*) you can check the current mode for the transfer of files by typing the command type at the FTP prompt. The system responds by displaying the current mode. To change the mode:

- Type `ascii` to set the ASCII mode for file transfer. This is the default mode.
- Type `bin` to set the binary mode for file transfer. Note that binary files *must* be transferred in binary mode only.

Do this before transferring any files.

### Transferring files from the SDS/VCO to a remote host

After logging-on (refer to *Section 1.12.8*) and setting the file transfer mode, follow the steps below to copy a file from the SDS/VCO system to the remote host.

*Note: In this document, the term remote host is used in reference to the SDS/VCO—a host that is not co-located with the SDS/VCO. When FTP commands are entered on the remote host, the SDS/VCO is "remote" from the FTP point of view.*

1. Set the directory on the remote host to where the file is to be transferred. To do this, type:  
`lcd pathname`  
where `pathname` is the directory on the remote host.
2. Set the directory on the SDS/VCO to where the file resides. To do this, type:  
`cd pathname`  
where `pathname` is the directory on the SDS/VCO. This directory must be on the C: drive.
3. Transfer the file from the SDS/VCO to the remote host. To do this, type:  
`get filename`  
where `filename` is the name of the file to be transferred.

If you want to change the name of the file when you transfer to the remote host, use the following command:

```
get filename new_filename
```

where `new_filename` is the designated filename on the remote host, after the transfer. The original filename on the SDS/VCO remains the same (as indicated by *filename* in the above command).

### **Transferring files from remote host to the SDS/VCO**

After logging-on (refer to *Section 1.12.8*) and setting the file transfer mode, follow the steps below to copy a file from the remote host to the SDS/VCO system.

1. Set the directory on the remote host to where the file to be transferred resides.  
To do this, type:  
lcd pathname  
where pathname is the directory on the remote host.
2. Set the directory on the SDS/VCO to where the file is to be transferred.  
To do this, type:  
cd pathname  
where pathname is the directory on the SDS/VCO. This directory must be on the C: drive.
3. Transfer the file from the remote host to the SDS/VCO. To do this, type:  
put filename  
where filename is the name of the file to be transferred.

### **Additional FTP Commands**

The following is a list of additional commands that you can type at the FTP prompt to manipulate the files and directories.

**Command:**           **ls**

Use:                   Lists the files in the current directory.

**Command:**           **dir**

Use:                   Lists the file and directory names in the current SDS/VCO directory, along with additional information such as size, date of creation, and date of recent modification.

**Command:**           **pwd**

Use:                   Displays the current directory pathname.

**Command:** ***cd pathname***  
**Where:** pathname is a directory  
**Example:** cd /home/server/summa4  
**Use:** Changes the current directory to the directory indicated by pathname.  
In the example above, the directory would be set to /home/server/summa4.  
**Note:** Use only absolute pathnames starting with /.

**Command:** ***mkdir dirname***  
**Where:** dirname is a directory name  
**Example:** mkdir ftpfiles  
**Use:** Creates a new directory under the current directory.  
In the example above, the new directory would be ftpfiles.  
**Note:** If you are unable to create a directory (typically as a result of restricted privileges), an error message is displayed.

**Command:** ***rmdir dirname***  
**Where:** dirname is the directory name  
**Example:** rm summa4  
**Use:** Removes the directory indicated.  
In the example above, the summa4 directory would be removed (deleted).  
**Note:** The directory must be located in the current directory.  
If the directory does not exist, an error message is displayed.

**Command:** ***delete filename***  
**Where:** dirname is the directory name  
**Example:** delete temp.file  
**Use:** Deletes the file indicated from the current directory.  
In the example above, the file named temp.file would be deleted.  
**Note:** If the file does not exist, an error message is displayed.  
If the file does not reside in the current directory a pathname should be included in the command.

**Command:** `rename old_filename new_filename`

**Where:** `old_filename` is the current name of the file and `new_filename` is the new name for the file

**Example:** `rename sds vco`

**Use:** Renames the file to the new name as indicated.  
In the example above, the file named `sds` would be renamed to `vco`.

**Command:** `rename old_dirname new_dirname`

**Where:** `old_dirname` is the current name of the directory and `new_dirname` is the new name for the directory

**Example:** `rename sdsdir vcodir`

**Use:** Renames the directory to the new name as indicated.  
In the example above, the directory named `sdsdir` would be renamed to `vcodir`.

**Command:** `bye`

**Use:** Exits the FTP application.

**Command:** `close`

**Use:** Closes the FTP session, leaving the FTP application invoked.

## 1.13 INVERTED E&M

Support for the Inverted E&M protocol is included with V4.2 FSR00. This protocol may be configured on ports of the 4xT1 and MVDC-T1 cards. Inverted E&M behaves identically to standard E&M except that the sense of the signaling bits is inverted.

### 1.13.1 User Interface—Inverted E&M Selection

There is a new **Select** value for the SIG TYPE field for T1 ports in the Programmable Trunk Card Configuration screen. This new value is IE&M, and is available only for T1 cards. This is shown in *Figure 1.19*. Ports 1 to 4 are configured for Inverted E&M and ports 5 to 8 are configured for standard E&M.

```

      P R O G R A M M A B L E   T R U N K   C O N F I G U R A T I O N

SPAN LOCATION: R, L, S 1 1 18-1   STATUS:      Out of Service
CARD TYPE:      Four Span T1 Card   SPAN TYPE: SF           CODE: AMI
TXGAIN: 0db    TCCLK: SCLK          SLIP: 255   LAW: Mu    LENG: 0-133
RXGAIN: 0db    RFCLK: LOOP          OOF: 17

PORT      TRUNK      GROUP      SIG      INPULSE
-----      -
1          -          -          IE&M     0
2          -          -          IE&M     0
3          -          -          IE&M     0
4          -          -          IE&M     0
5          -          -          E&M      0
6          -          -          E&M      0
7          -          -          E&M      0
8          -          -          E&M      0
    
```

Figure 1.19: Programmable Trunk Card Configuration Screen

## 1.14 HOST FAILURE DETECTION

Prior to this release, if there was an Ethernet link failure and the host did not close the socket properly, the time frame for detection could be two to three minutes for two or more hosts configured for cyclic call distribution. This time frame was unacceptable.

The detection of Ethernet link failure is now done in a reasonable time frame, 6 to 15 seconds, and failure handling can be configured on a host-by-host basis. You can configure the system to do nothing, to tear down calls on a link, or to clear the controlling host. (Refer to the *System Administration Guide* for these existing features.)

### 1.14.1 Summary of Features

The major functionality in this release includes:

- detection of lost-of-host connection via a probing packet (ping) from the switch over each link
- user-defined time between probes, and number of consecutive failed probes to determine a broken link, on a per-link basis
- automatic closing of the connection, and the generation of alarms when there is a lost connection
- support for the previous one-minute ping frequency scheme

If the consecutive failure count reaches the limit you've specified, the connection is considered to be broken. The switch closes the connection by freeing up all sockets tied to the local ports, and generates alarm messages.

*Note: The ping mechanism is mandatory for all network devices supporting the Internet suite of protocols. It detects any link failure but does not give much information about the state of the host application software. However, the current Generic contains a feature that deals with host application problems, such as shortage of processing time, host application bugs, or network congestion. There is a Host Timer option in the System Configuration screen that you can enable and for which you specify a time-out period for a call setup. If the host does not respond within the defined period of time, the Generic tears down the call and logs the error condition, but performs no necessary steps to restore the service.*

### 1.14.2 User Interface

Once the host is configured with *Ethernet* from the Host Configuration Screen, enter the probe frequency and failed probes limit to facilitate this feature. There are two new fields in the Host Configuration Screen. Refer to *Figure 1.20* and note the new fields, which are illustrated in bold type.

H O S T C O N F I G U R A T I O N

Interface	Interval				
Host Name	Overlay				
Trace (1/0)	0				
Interface	Ethernet	Connect.Password		Loc. Port	2000
Host Name	Host0	Rem. Inet. Addr	1.2.3.4	Rem. Port	2001
Trace (1/0)	1	Failure Action	Call Teardown		
Protocol	TCP	Alarm State	On	<b>Ping Freq</b>	<b>6</b>
Reset Time	60	<b>Ping Fail Limit</b>	<b>2</b>		
Interface					
Host Name					
Trace (1/0)					

Figure 1.20: Host Configuration Screen

The **Ping Frequency** field defines the time in seconds between probes. The range for this field is 0 to 60. The default for this field is zero (0), which indicates that probing will occur as it did prior to this enhancement—once every minute.



The **Ping Fail Limit** defines the number of consecutive failed probes to determine that a connection is lost. The range for this field is 0 to 10.

The **Ping Fail Limit** default is one (1), if the Ping Frequency is non-zero. (The default of one can be overridden with any value other than zero.) The default is zero (0) if the Ping Frequency is zero. (The default of zero cannot be overridden.) This is the previous once-a-minute probing. Any missing probe will be declared a lost connection.

In the sample screen in *Figure 1.20*, the probe frequency is set to six seconds and the number of failed probes is set to two. This means that the system will probe the remote host every six seconds and the switch will determine that a connection is lost when there is no response from two consecutive probes. This configuration defines a 12-second time frame for failure detection.

To disable the feature, set the **Ping Frequency** to zero. To disable all pinging, set the Remote Internet Address to INADDR\_ANY.

## 1.15 CONFIGURABLE IP SUBNET MASK

Previously, SDS/VCO systems supported only class C subnets. Class A and B subnets are now also supported.

### 1.15.1 Summary of Features

With this release, you can:

- configure the subnet mask from the on-line Ethernet/NFS Configuration menu or from the Ethernet installation disk
- reboot the system after changing the subnet mask in order for the new value to take effect

### 1.15.2 User Interface

For on-line configuration of the subnet mask, the Ethernet/NFS menu has changed. A new System Subnet Mask field has been added for specification of the desired subnet mask. See *Figure 1.21*.

```

      E T H E R N E T / N F S   C O N F I G U R A T I O N

Current System Internet Address      = 204.160.248.126___
New System Internet Address On Reboot = 204.160.248.126___
Enable NFS File Access              = Y
NFS Server Internet Address         = 204.160.248.81___
NFS Server Name                     = venus_____
NFS Mount Directory Point           =
      /home/server/sds_____
Target System Name                   = shields_____
Target System User Id                = 131_____
Target System Group Id               = 12_____
Target System Umask                  = 0_
System Subnet Mask                 = 255.255.255.0_____

Gateway Routing Configuration        = _
  
```

Figure 1.21: Ethernet/NFS Configuration Menu

When Ethernet is initially installed, the system reads the Current System Internet Address and supplies a default value for Class A, B, or C subnets in the System Subnet Mask field. If you want to change the class after the initial installation, type one of the values shown in the table below into the field. If you assign a new class of IP address at some point after the initial installation, you must also type in the appropriate system subnet mask. The system will not automatically reconfigure subnet mask based on your new IP address.

IP Address Class Type	Default Subnet Mask
A	255.0.0.0
B	255.255.0.0
C	255.255.255.0

Section *Section 3* and *Appendix B* of this manual reflect the addition of the configurable subnet mask feature.

## 1.16 CORE DUMP

The Core Dump feature results in the automatic storage of detailed information in either of the following two cases:

- When the system is shutdown following a system failure
- At the user's request with or without a system initiated shutdown (refer to *Figure 1.22*)

When a core file is generated, the system writes an entry into the log file specifying that the file was generated.

The information in the core file contains data sets with information regarding the reasons the file is being created and why the system failed. The core file contains the following information:

- System version, revision, and FSR number
- Failure mode
- Context of failed task
- Register information
- Time and date
- Memory image (volatile and non-volatile)

### 1.16.1 Functionality

The Core Dump functionality is outlined below.

- The system automatically creates a core file when there is an exception, a watchdog time-out, or by operator request.
- The creation of a core file which includes the reason for failure, system data, context data (if appropriate), and memory contents.
- Failure data is no longer written to the log file.
- Exception data now includes system and stack data at the time of the failure.
- The watch dog allows for the specification of the failed task in the event of a watch dog time-out.
- The system automatically switches over in the case of a shutdown (redundant systems only).

### 1.16.2 File Handling

The core file is written to the *C:/* directory. When a system is initialized, it checks to make certain there is enough disk space for the largest core file. If there is not enough space, a message is issued indicating a problem. Refer to *Section 1.16.5* for the list of new messages.

When a core file is generated, the file is named *core1*. Note that *core1* is the *current* core file. If a core file already exists in the directory, that file's filename is increased by one and it is saved as *core2*. If *core2* existed, it becomes *core3*; *core3* would become *core4* (old *core4* is overwritten by *core3*). The system maintains up to four (4) core files. The file named *core4* is the oldest.

### 1.16.3 Maintenance Menu Screen

There is a new option in the Maintenance Menu screen to accommodate the Core Dump feature, refer to *Figure 1.22*. To initiate a core dump, type K and press the Enter key. Note the shutdown option that appears when the Core Dump option is selected (refer to *Figure 1.22*, (bottom right of screen)).

- To shut down the system after a core dump:  
Type Y and press the **Enter** key. When this option is selected, the system prompts the user for confirmation: ENTER To Confirm Core Reboot  
To confirm the shutdown, press the **Enter** key.
- If the system is to be kept in operation after the core dump:  
Type N and press the **Enter** key. This is the default option.

*Note: If you press the Enter key and do not indicate a SHUTDOWN option, the system will remain in operation after the core dump.*

When the **Enter** key is pressed in answer to the SHUTDOWN option, the core file is generated.

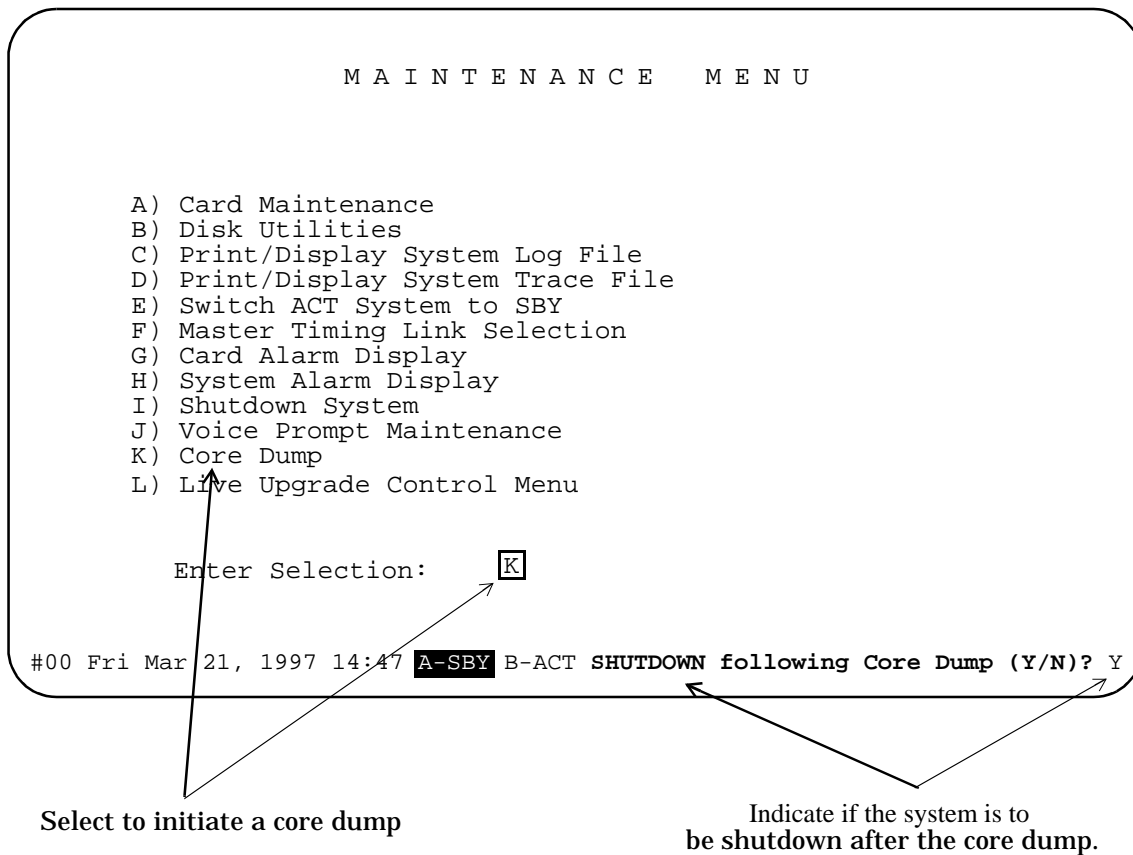

Figure 1.22: Maintenance Menu—Core Dump Option

#### 1.16.4 Sending a Core Dump File for Analysis

You may be asked to send a core dump file to Summa Four for analysis. Some methods that you can use to copy the file from the SDS/VCO are listed below. A Summa Four Customer Service representative can assist you with copying, and sending the file to Summa Four.

- Use FTP, the Remote File Transfer feature on your VCO system (refer to *Section 1.12*) and transfer the file to one of your workstations.
- If you have the Ethernet option and NFS, mount the F: drive (the network drive) and move the file to the F: drive. After the file is on the network drive you can use a file transfer method with which you are familiar, or a Summa Four customer service representative can assist you with sending the file to Summa Four.

*Note: Do not send the core dump as an E-mail attachment. The size of a typical dump can easily exceed the receiving system's mail handling capacity.*

- Split the core dump (core1) file and copy the resulting file segments on to floppy disks, and mail them to Summa Four. Refer to the *Section 1.12.4* for more information.

#### 1.16.5 New FRM Messages for Core Dump

There are four (4) new FRM messages related to the Core Dump feature. They are:

FRM529: Insufficient disk space in case of crash (*n* bytes free)

Where *n* is the number of free bytes on the C: drive

FRM530: Unable to open a Core File - Cause=*xxx* PC=*yyy*

Where *xxx* is a string indicating the cause of the problem and *yyy* is the program counter's contents.

FRM531: Core File Created - Cause=*xxx* PC=*yyy*

Where *xxx* is a string indicating the problem (program) that initiated the core dump, and *yyy* is the program counter's contents.

FRM532: Core File Created WITH ERRORS - Cause=*xxx* PC=*yyy*

Where *xxx* is a string indicating the cause of the problem and *yyy* is the program counter's contents.

## 1.17 PROBLEMS CORRECTED IN V4.2

The following problems have been corrected in V4.2.

TR #	Corrected Problems
U609270002	<p>Prior to this fix, the NBC would NACK the expected buffer rather than ACKing a retransmitted buffer. NACKing the expected buffer had two possible effects: 1) the expected buffer was transmitted before it was ready, 2) the expected buffer was transmitted twice. In case 2, this could cause a chain of double buffer transmittals.</p> <p>This could result in a system failure because of the way the system handles a FLUSH string when a buffer is sent.</p> <p>The system now recovers from the FLUSH condition.</p>
U701090002	<p>On cold boots with various cards in the database the system would receive \$9 time-outs on a variety of cards. If the system had DRC24s installed, the problem would occur every time; however, if a DRC48 was also in the system time-outs did not occur.</p> <p>Time-outs no longer occur with any combination of cards.</p>
U702180002	<p>Previously, if customers who did not have C-bus requested a large number of subrate switching timeslots, a failure could occur and cause the system to store an invalid port address. The problem arose because the timeslots were not allocated contiguously.</p> <p>Timeslots are now allocated contiguously, and if a timeslot is not available, an error is generated.</p>
U702270001 U611120002	<p>Previous systems would communicate over a network only if Class C IP addressing was used. That is, the first three bytes of the address had to be the same on both machines.</p> <p>The system now supports Class A and Class B type subnets in addition to Class C. See <i>Section 1.15</i>.</p>
U703270001	<p>VCO/20 systems with a single SSC card and with four or more 4xT1s in the data base, would fail to come into service on reboot. The SSC timed-out before all four of the 4xT1 cards could be reset by the NBC. Each 4xT1 was treated as four separate reset operations.</p> <p>The SSC card now becomes active with all 4xT1 cards in the data base.</p>

TR #	Corrected Problems
U704040003	<p>The \$49 command has a feature for suppressing a \$EA disconnect report following a \$45 event (DISCONNECT message received). This feature is armed by the "D" bit in the Disconnect Control Byte. This disconnect was not functioning correctly because all disconnects were being reported to the host.</p> <p>This has been corrected by the addition of a feature flag that allows users to choose how ISDN disconnect reports are handled. With reports enabled, the system functions properly with Japanese ISDN. With reports disabled, operation is consistent with Generic releases prior to V4.2.</p> <p>See <i>Section 1.9.2</i>.</p>
U704150009	<p>The Administration Main Menu was missing FSR and PUN release information. This information now appears correctly.</p>
U704150010	<p>The Software/Firmware Configuration Screen had misaligned elements. These have been corrected.</p>
U704170001	<p>After approximately 28,000 subrate paths had been established and torn down, the system would start exhibiting memory allocation errors with the message: "Architecture Error 1: Memory Allocation Error." No subrate call processing would then be performed.</p> <p>The system no longer experiences memory allocation errors and will operate to many times the 28,000 threshold without error.</p>
U704240003	<p>The previous release (V4.0 FSR02) unintentionally reset function key mapping when earlier systems were upgraded. This was not seen by customers receiving new systems, because it was corrected at Summa Four prior to shipment of new systems.</p> <p>Function keys now retain the default key mapping that existed prior to upgrade.</p>
U705010001	<p>Previously the NSB returned values of \$54 and \$55 were improperly assigned to two different commands.</p> <p>For the \$65 command these are now assigned with the following values and meanings: \$5F - Subrate channel must be greater than zero and less than or equal to eight. \$60 - Subrate channel crosses bearer channel boundary.</p>
U705070007	<p>Occasionally, all B-channels in an NFAS group would remain in OOS-NE, after both primary and backup D-channels were lost and then returned. Now when both primary and backup D-channels are lost and then returned, the B-channels go into IN-SERV state.</p>

TR #	Corrected Problems
U705120013	<p>Prior to this fix, the IPRC-8, -64, and -128 cards could fail diagnostics run from the Test Service Circuit option of the Diagnostics menu. Failure results in the following message type: DGN08: IPRC RLS xxx No Response From DRAM Test, where xxx is the rack, level, slot of the IPRC card. A message indicating test failure follows.</p> <p>All tests run to normal completion and report success or failure within three minutes. Results are displayed and sent to the log.</p>
U705120014	<p>Prior to this fix the diagnostic utility for IPRC-8, -64, and -128 cards did not indicate which of the three tests (DRAM, SCSI Interface, or PCM Interface) failed.</p> <p>Test failure type is now presented in the message "DGN10 IPRC RLS xxx &lt;Test Type&gt; Failed." This message is sent to the terminal and to the log file.</p>
U705290004	<p>Previously, if an LOC alarm was generated on a 4x span, a \$D9 report was generated to the host. When this alarm was cleared, another \$D9 report was sent to the host. However, immediately following the alarm clear another Remote alarm was generated. This alarm was cleared immediately and generated another \$D9 report. The two \$D9 reports could not be handled by the SS7 interworking software.</p> <p>Now only one report is generated for each span.</p>
U705290005	<p>Previously, when an incoming ISDN call in Overlap Receiving state was routed to an outgoing NON-ISDN call and a true answer was detected from the outgoing side, the CONNECT message did not get propagated back to the incoming port.</p> <p>I_OVRLP has been added to the list of states in the Generic that support CONNECT message propagation. Stable calls are now established.</p>
U705290006	<p>Previously, in systems configured with primary/secondary incoming timing, if the primary timing was not available on system reboot, the secondary timing source was shown incorrectly as 1-1-1.</p> <p>Now, when the system is rebooted, the correct timing source is always displayed.</p>
U705290007	<p>When a \$49 command was sent by the Host for processing an outpulse rule requiring CPA for supervision on the outgoing port, the system failed to reject the command when the CPA port was unavailable.</p> <p>Now, if a CPA resource limitation exists, the \$49 command will be rejected with a NSB of \$3A, no CPA port available.</p>



TR #	Corrected Problems
U705290008	<p>Previously, if a non-active ISDN port was added into a conference, when the port was deleted from conference or the conference was torn down, the port went to CP_IDLE instead of staying in CP_SETUP, even with \$6D command specifying to leave the port in CP_SETUP.</p> <p>Now the ISDN port is left in CP_SETUP state.</p>
U705290009	<p>Prior to this fix, a burst of host commands sent to the switch could overflow the CP_MSG queue. In some installations, this occurred during host initialization. It could also occur following a host link failure as calls were reassigned. Data was lost and the system may have rebooted.</p> <p>CP_MSG no longer overflows.</p>
U705290010	<p>Occasionally, all the ports on a 4xT1 or 4xE1 span would become stuck in Major state CP_DISC and Supplementary RDR_QUIET.</p> <p>Now, when the Generic receives a report from a span with an error code indicating a time-out error, it logs the error and resets the span.</p>
U705290013	<p>Previously, when a \$69 command was issued to process an outpulse rule on an Idle COS A2 or 2 port, the system would become stuck in CP_OUTPULSE state. The port would remain stuck even after going off-hook and then on-hook, or being P'd out. The only way to clear the port was to take the card OOS and then reactivate it.</p> <p>Now processing using the \$69 command is possible only on an outgoing port that is already off-hook.</p>
U706020002	<p>Previously, when a card was deleted from the database an extra \$D9 report was issued stating that card 1-1-1 (NBC) had been deleted as well. This extraneous report has been removed.</p>
U706030003	<p>Occasionally the system would shut down with Network manager failure or "Call Chain Dump:..." following system reboot under load.</p> <p>The system no longer shuts down with a Network manager failure.</p>
U706030004	<p>Previously, when a \$82 command was issued to request card status for the DRC24/48, the command could return the wrong port address for the card.</p> <p>The correct port address is now returned.</p>
U706040001	<p>Previously, under some circumstances, activity at the system console while a telnet session was occurring could cause the system to shut down.</p> <p>This problem has been corrected.</p>

TR #	Corrected Problems
U706060001	<p>Prior to this fix, when a 4xE1 port configured for CAS Mercury received an incoming call, the 4xE1 did not transmit signaling bits to seize. The call timed out and was torn down.</p> <p>Signaling bits are now sent.</p>
U706130001	<p>Previously, the log file would show an intermittent alarm clear without a corresponding indication of its having been set. This has been corrected.</p>
U706230002	<p>During installation of the Generic software, the program would issue a the following error message: "File not found: the final filename part of the pathname does not exist." This did not occur during software update, nor during optional software installation. This has been corrected by modifying the way directories are checked.</p>
U706240001	<p>Previously, duplicate \$D9 reports could be issued to the host when a single span E1 card was manually changed to out-of-service state. This issue has been fixed.</p>
U706240002	<p>Previously, duplicate \$D9 reports could be issued to the host when a single span DRC-8 card was manually changed to out-of-service state. This issue has been fixed.</p>
U706240006	<p>A system configured with 40 DPNSS cards would not complete download of the DPNSS cards. This issue has been fixed.</p>
U707080002	<p>Normal operation when a card is removed (unseated) results in an FRM101 CARD OOS sent to the log files. The host receives an \$F0 report. When the card is reseated, an FRM095 CARD RESTORED is sent to the log files. An \$F0 report is also supposed to be sent to the host, but this did not occur.</p> <p>When a card is reseated the \$F0 report is now sent to the host.</p>
U707180001	<p>Previously, if Report Call distribution was set to CYCLIC, all the reports were sent to a single host rather than alternating between hosts as expected. Changing Host Control of Call Load to DISABLE had no effect. Both hosts were able to process calls, but could not load share.</p> <p>Now when distribution is set to CYCLIC reports alternate between hosts and load sharing occurs.</p>
U707300003	<p>To set the switch up for ISDN Overlap Receiving or Sending, the switch needs to be configured with ISDN Message templates containing SETU-PACK and INFO tokens. The INFO token was added in an earlier release, but the SETUPACK token was inadvertently omitted.</p> <p>The SETUPACK token is now available via the SELECT key.</p>

TR #	Corrected Problems
U708210006	Previously, while it was not necessary to perform a database conversion following a full installation, if a user invoked database conversion following a full installation, there was a message indicating that the card table had been converted, although (correctly) it had not been. There were no adverse consequences other than the unexpected message. This issue has been remedied.

## 1.18 PROBLEMS CORRECTED IN V4.2 FSR00 PUNS 22, 23, AND 24

The following problems were corrected in V4.2 FSR00 PUN22:

TR #	Corrected Problems
U706250004	<p>Previously, if a bad DRC-48 card or a DRC-48 that was not in the database was inserted in a slot, an "FRM341: NBC Error - Comm Bus Interf- DID err, 3 reset/polling cycles done" message was generated in the Log file. Once this message appeared, the DRC-48 card would not activate other than via the console.</p> <p>This has been fixed. A DRC-48 card inserted after the FRM341 message will now activate by itself without manual intervention.</p>
U706250005	<p>5191: There are now log messages that indicate the PCM coding configuration (A-Law or <math>\mu</math>-Law) whenever a 4xT1 or 4xE1 card is brought into service: "FRM103: T1/E1 Card Configured for U-Law- RLS X,X,XX-span" and "FRM104: T1/E1 Card Configured for A-Law - RLS X,X,XX-span." When the configuration is changed, the message indicates the change.</p> <p>4.2 DS: While restoring the 4xT1/E1 card, the log messages for the configuration of the A Law/Mu Law were not found in the log file. These should have been generated to indicate the PCM coding law configuration used whenever the card was brought into service or when the configuration was changed for the PCM coding law.</p> <p>New behavior: When a span of 4xT1/W1 card is activated, its PCM coding law is indicated by a log message "FRM125: T1/E1 Card Configuration For U-Law - RLS X,X,XX-span" or "FRM126: T1/E1 Card Configuration For A-Law - RLS X,X,XX-span" is printed to the log file and on the console terminal.</p>
U707290001	Previously, when the system attempted to write to a protected floppy disk, a misleading error was returned. The message was: "Error During Disk Operation." The correct message now appears: "Error: Disk Write Protected or Bad."

TR #	Corrected Problems
U708070003	<p>Previously, during a switchover from Active to Standby, all ports on the new standby side in CP_SUBRAT state were forced to CP_IDLE.</p> <p>Normally ports in CP_STAB, CP_BUSY and CP_SETUP (with Basic Redundancy) are forced to CP_IDLE. Attached resources are also released. Ports in CP_SUBRAT were treated similarly.</p> <p>Ports in CP_SUBRAT are no longer affected, even in systems with Basic Redundancy.</p>
U708130003	<p>Previously, if a bad MFCR2 card or a MFCR2 that was not in the database was inserted in a slot, an "FRM341: NBC Error - Comm Bus Interf- DID err, 3 reset/polling cycles done" message was generated in the Log file. Once this message appeared, the MFCR2 card would not activate other than via the console.</p> <p>This has been fixed. An MFCR2 card inserted after the FRM341 message will now activate by itself without manual intervention.</p>
U708130004	<p>Previously, if a bad card or a card that was not in the database was inserted in a slot, an "FRM341: NBC Error - Comm Bus Interf- DID err, 3 reset/polling cycles done" message was generated in the Log file. Once this message appeared, any valid card (configured in the database) would not activate other than via the console.</p> <p>This has been fixed. A card inserted after the FRM341 message will now activate by itself without manual intervention.</p>
U708130006	<p>Previously, if a bad IPRC-64 card or a MFCR2 that was not in the database was inserted in a slot, an "FRM341: NBC Error - Comm Bus Interf- DID err, 3 reset/polling cycles done" message was generated in the Log file. Once this message appeared, the IPRC-64 card would not activate other than via the console.</p> <p>This has been fixed. An IPRC-64 card inserted after the FRM341 message will now activate by itself without manual intervention.</p>
U708220002	<p>Previously, if a bad NBC-3/DTG-2 card or a NBC-3/DTG-2 that was not in the database was inserted in a slot, an "FRM341: NBC Error - Comm Bus Interf- DID err, 3 reset/polling cycles done" message was generated in the Log file. Once this message appeared, the NBC-3/DTG-2 card would not activate other than via the console.</p> <p>This has been fixed. An NBC-3/DTG-2 card inserted after the FRM341 message will now activate by itself without manual intervention.</p>

TR #	Corrected Problems
U710130001	<p>There was an issue in which 4xT1 cards took an excessive amount of time to report an inward seizure. In addition, the 4xT1 port did not report the seizure within a consistent time period. The FXS ground start timer was changed to a "one-phase" counter which is tested against a configurable timer value. An FXS or FXO ground start port on the 4xT1 card will now report an inward seizure after the off-hook timing requirement has been satisfied.</p>
U710140005	<p>Previously, the size of the DBvers.tbl failed to properly update after a database conversion. In the previous Generic release the table size was 306 bytes, which remained unchanged. (This was further complicated by the fact that the empty table size in V4.2 is 324 bytes.) In a related matter the table size remained at 288 bytes following an upgrade from a V3.3 database.</p> <p>The table size after upgrade is now 324 bytes.</p>
U710290003	<p>The MVDC-T 1 card experienced problems with set up for conference calls. No voice path was established to the DCC even after the port was properly added to the conference. The code has been changed to allow set up of the MVDC-T1 card with the \$6D command in the same manner as the 4xT1 card.</p>
U711030003	<p>A problem occurred when MVDC-T1 spans were used for primary and secondary incoming timing source. Following a primary loss the timing did not switch to secondary. Instead, the internal clock was used. This was fixed as part of a more general solution to the problem of a failure to switch to internal timing for a momentary (less than two second) loss of carrier and when no secondary timing was configured.</p> <p>MVDC-T1 cards now switch properly to secondary timing (when previously so configured).</p>
U711120004	<p>Previously, when a 4xT1/E1 span was taken out of service from the Maintenance menu, both active and standby sides of a redundant system sent a \$D9 report to the Host indicating an OOS state. When the span was restored, a \$D9 report was generated only by the active side. The Host connected to the standby side did not receive a report.</p> <p>The code has been modified to remove a check of the active/standby side status associated with the span before the \$D9 message is sent. The result is that a \$D9 message is generated both active and standby sides of a redundant switch.</p>
U711120006	<p>The VCO system was designed to present a fast busy (reorder) tone during PSC processing on a port. This fast busy tone is not supported in Japanese networks. The normal busy tone is, instead, used in Japanese networks. This has been accommodated by the addition of a feature flag on the System Features screen. This feature "Convert Reorder Tone To Busy" when set to "Y" results in the normal busy being presented to the caller instead of fast busy.</p>

The following problems have been corrected in V4.2 FSR00 PUN 23:

TR #	Corrected Problems
U604190004	Previously, when a span was taken out of service on a 4xE1, the green LED did not illuminate. It now does so, to indicate an OOS span.
U610030003	<p>Cold boots would intermittently cause an error "FRM051 Error Reading Download File-Code 0x73e Filename C:/boot/4xE1.dwn" and "... Filename C:/boot/mvdct1.dwn." The cards would then load properly. This problem occurred more frequently with a greater number of cards (such as 4xT1/E1s).</p> <p>The messages no longer occur during a cold boot.</p>
U704090001	<p>If the external timing source was connected only to the active side NBC-3, or if the external timing source was removed from the standby side, the standby side continuously reported FRM020 and FRM040 messages reporting the failure to obtain an external clock on the standby side. This was because the Generic did not inform the NBC-3 to switch to internal clock.</p> <p>Now, when the standby side NBC-3 reports an inability to sync to the external clock, the Generic instructs the NBC-3 to switch to internal clock. The NBC-3 selects internal clock and sends an acknowledgement message to the Generic.</p>
U706230001	<p>This was a problem that occurred with PRI/N call processing. The switch would intermittently report "FRM182: Outpulsing In Incorrect State - RLSP x, x, xx, x." This was caused by an error of the Generic code that failed to perform a check on the state of the port before a call.</p> <p>Now the outgoing port is released as expected and no FRM182 report is generated.</p>
U707080004	The problem of new trace files not being created at midnight, even when the trace was left enabled, has been corrected.

TR #	Corrected Problems
U707300004	<p>When the external timing source was lost, the system would switch to the internal timing source. However, once the external timing source was restored, the system did not switch back to external as it should have. In addition, upon external timing source loss, a major alarm was not generated.</p> <p>The corrected behavior of the system is that a major alarm is now set and cleared when the external clock is lost and then recovered. The following FRM messages are displayed and sent to the log:  FRM504: Major Alarm Set For - ALM067: NBC Loss of External Sync.  FRM511: Major Alarm Clear For - ALM067: NBC Loss of External Sync.  These alarms also appear under the Major alarms of the System Alarms Display option.</p> <p>In addition, \$F0 reports similar to the following are sent to the host when ALM67 is set and cleared:  df 44 00 00 f0 43 05 01 05  df 44 00 00 f0 43 00 00 00  The \$43 in the \$F0 report indicates this new alarm code.</p> <p>Also, upon external timing reference loss, the Generic tries three times, at one minute intervals, to reselect the external clock. If the NBC3 reports a success on the first attempt, subsequent attempts are aborted. If the incoming timing source is selected immediately after the external timing reference loss, the Generic aborts the external clock selection.</p> <p>Since the host now receives an indication of the external clock loss, it can send a \$C002 command at any time to retry selecting the external source, or switch to an incoming source.</p>
U708010008	<p>Previously, the inactivity time on remote terminals was inconsistent; the timer would vary from three to eight minutes. Now, if a user logs on to a remote terminal and then does nothing, after five minutes have elapsed the connection is closed with a logout message.</p>
U708140001	<p>There was a problem with the IPRC card still being able to run diagnostics while it was active. Users would see the proper message, "ERROR: Receiver NOT in Diagnostic Mode." However, if the user pressed the Enter key, the test would run. This problem has been corrected.</p>
U708200006	<p>Previously, when a card was deleted through the admin console on the active side, the number of timeslots on the active side was reduced by the number of timeslots occupied by the deleted card. The number of timeslots on the standby side however, was not reduced. This could cause problems if a switchover to the standby side occurred, since these timeslots remained occupied as far as the system was concerned, and therefore, would remain unused.</p>

TR #	Corrected Problems
U709020009	<p>There was a problem with the standby side NBC3: when the card was pulled out of the slot, the active side continued to display its status "S" (standby) instead of "O" (out of service). Now, the active side takes the card's state to out of service and declares an update channel failure.</p>
U709110001	<p>There was a problem with running diagnostic tests on the IPRC. Users could not stop the test by pressing a key, and the screen would lock until the tests were completed. Now, if an operator presses a key, the tests are aborted and the DGN09 or DGN11 messages are displayed.</p>
U709120005	<p>Previously, when users printed the Database Detail from the Database Administration menu, the Ethernet TCP/IP and/or Subrate Configuration detail was not included.</p>
U709170001	<p>A problem existed when a cable was pulled for fewer than two seconds from a carrier which was acting as the primary timing source. (For that brief a period of time, no alarms are generated.) The NBC3 however, would lose its synchronoization to the incoming timing source. Therefore, if no secondary timing source was configured, the VCO switched to internal instead of trying to use the primary again.</p> <p>Now, if a cable is removed from the adapter of a card (span) being used as primary timing source for less than two seconds, the Generic will try to use it again, rather than switching to the internal clock and generating alarms.</p>
U709230001	<p>When a \$49 command is used to connect a controlling port and an associated port for an outgoing call, the active side removes the start and end records after redirecting the associated port (from incoming to outgoing). An issue previously existed in which the standby side's start and end records were not deallocated properly. This caused the start and end records to accumulate until they exceeded the memory pool size. In addition, the number of allocated start and end records were not in synch between the active and standby sides, and the number of start and end records would not reset to zero, even after the call had been torn down. The system could not deallocate the start and end records while the major state of the standby side's ports were in CP_SETUP.</p> <p>With this release, the \$49 command's connection operation deallocates the start and end records on both the active and standby sides, if the associated port is formerly allocated with those records. Therefore, the start and end record exhaust condition will not occur on the standby side due to this call scenario.</p>
U710140001	<p>When the card used for Incoming Primary timing was pulled, the switch went to Internal timing rather than Secondary timing.</p> <p>Secondary timing is now used when the Primary timing card is pulled.</p>



TR #	Corrected Problems
U710240003	<p>The \$72 command (seize and unseize a port) sent to the switch did not function properly. When a \$72 command was processed to seize a port, the port should have been flagged as SEIZED. Instead, it was flagged as ANSWER. Therefore, the system saw nothing to unseize and the port remained unavailable.</p> <p>The conditions of the port are now acknowledged properly.</p>
U710280002	<p>The class of service bits are set according to the characters entered. Valid characters are A, O, T, and 2, or a combination of these characters. However, the software did not reject certain invalid combinations. If a call was routed through this port the switch rebooted. This was found in Line, Trunk, and PRI Card configurations.</p> <p>The port's class of service bits are now verified. If invalid, the function's logic rejects it and an error message is printed.</p>
U710300006	<p>When the AM2-D bulk call generator was configured as FXOGS, and the MVDC T1 card configured as FXSGS, only 50% of the calls were processed. After the first call, the ports stayed in CP_GARD, GD_NORMAL mode. The next call from the load box hung up the port. The MVDC T1 card saw 100% completions and the load box only saw 50% completions.</p> <p>The MVDC T1 card now reacts faster when it gets the seizure. When the MVDC T1 is commanded to abandon a call, it now goes back to an IDLE condition in a reasonable time. The port is no longer hung in an infinite loop.</p>
U711010001	<p>The System Administration master console would hang if the MVDC T1 diagnostics were running in 'Continually Loop Through Test' mode, and the MVDC T1 was pulled out of the subrack and then reinserted. The card downloaded and resumed running, but the console did not accept keystrokes to terminate the diagnostics.</p> <p>The diagnostics tests are now only run on an MVDC T1 card which is in the diagnostic state. If the card goes to an out-of-service (OOS) state, the test loop is terminated. The operator is notified, via a console message, that the diagnostics test has been terminated due to a card going OOS.</p> <p>Two new diagnostic messages are associated with this fix:  "DGN45: %s Test Aborted, Card Went OOS -ATP- %d Tests Executed"  "DGN46: %s Test Aborted, Card Went OOS -STF- %d Tests Executed, %d Failed"</p>
U712010001	<p>When the \$67 command was issued to remove a DTMF receiver from a port, the command was rejected, indicating that there was no resource of this type in the call's resource chain. The m_state of the controlling port was being changed when the receiver was detached.</p> <p>Now, when the command is rejected, the port's m_state does not change. The m_state is changed only when the command is executed successfully.</p>

TR #	Corrected Problems
U712090001	<p>The CPA Monitor Disconnect feature did not function properly. After a call was established, and the calling party disconnected, the UTC port did not return to an IDLE state.</p> <p>The UTC port is now released when the calling party hangs up.</p>
U712100002	<p>A feature was recently added to improve the speed of the system. However, due to an adjustment of calls-in-queue, the messages transferred between the switch and host were not being prioritized properly. This resulted in a HOST_TX_Q overflow.</p> <p>The enhancement has been removed and the calls in queue are no longer automatically running at a higher priority in order to continue processing without getting discarded.</p>
U712160003	<p>The system failed to switch from secondary incoming timing source to primary incoming timing source. The switch selected the secondary timing source. If not there, it searched for the internal timing source, even though the primary timing source was available.</p> <p>The system now successfully switches from the primary incoming timing source to the secondary incoming timing source and vice versa.</p>

The following problems have been corrected in V4.2 FSR00 PUN 24:

TR #	Corrected Problems
U610160001	<p>The MVDC erroneously reported PRI D-Channel Failure as a failure. This occurred even though the switch did not have either the PRI or PRI/N option installed. The correct alarm is T1 OOF. This was caused by an error string mismatch within alarm look-up. The correct alarm is now displayed.</p>
U702280004/ U710080002	<p>During the file sync, the standby side would sometimes report database errors (RED45: Standby DB Update Error). This has been fixed.</p>
U707300004	<p>There are two problems associated with this fix. The first occurred when the external timing source was lost. When restored, the switch did not continued to stay in internal source. The second issue was the failure to generate a major alarm when the external timing was lost.</p> <p>Now major alarm is set and cleared when the external clock is lost and then restored. The following FRM messages are displayed on the screen and are sent to the logs: FRM504: Major Alarm Set For - ALM067:NBC Loss Of External Sync (SA) and FRM511: Major Alarm Clear For - ALM067:NBC Loss Of External Sync.</p>

TR #	Corrected Problems
U708260018	<p>The IPRC prompt library maintenance screen failed to show the correct data for TOTAL USAGE. When initially entering the screen it shows 0:00. Subsequent entries show correct values. Also a message "Error - No Such Prompt ID" appears if you enter a library number followed by the enter key. This is an invalid error.</p> <p>The correct library data is now shown and the erroneous error message does not appear.</p>
U709100001	<p>When multiple NFAS groups are configured in a VCO switch and the D channel of the group (other than group 1) is taken down it causes all the B channels in group 1 to be OOS-NE (Out-Of-Service Near-End). The B channels in the broken D channel remain IN_SERV.</p> <p>Now when the D channel of a NFAS group goes out of service, only the B channel ports for that group become out of service.</p>
U710290004	<p>CP_MSG_Q overflow occurs as a result of burst commands from multiple hosts connected via Ethernet.</p> <p>Command bursts from multiple hosts via Ethernet are now handled at higher volume.</p>
U711040004	<p>Slip and OOF counters were not clearing at midnight on cards such as the MVDC, 4XT1, and 4XE1.</p> <p>Counters are now cleared at midnight.</p>
U711110006	<p>If a virtual port was allocated via a \$6A command, but not connected, the port was unavailable if the host connection was lost and then re-established.</p> <p>Now if the host connection is lost and host failure action is set to call teardown, the system makes virtual ports available for allocation in the future.</p>
U712080003	<p>When an ISDN command (\$49) was issued to tear down a T1 incoming call in CP_SETUP state, the switch crashed.</p> <p>This was an invalid command. However, the switch now accepts the command without crashing the switch.</p>
U712150005	<p>This was a problem of the switch supporting loads only to 68K. This is now fixed to run at 75K.</p>
<p>U801020001 related: U207293581 (TR3581) U603040003 U709100001</p>	<p>If the span carrying the active or backup D channel of an NFAS group goes out of service, the D channel is properly identified as out of service and (if active) is switched to the backup. The B channels, however, appear to be in service and available for calls when, in fact, they are not.</p> <p>The B channels are now marked OOS-NE rather than left as IN-SERV.</p>

TR #	Corrected Problems
U801130001	<p>4xE1 cards running in CCS31 signaling mode were reporting MFA alarms that were inconsistent with the mode. Alarms were being generated for channel 17 for OOF, AIS (remote alarm), or all zeros for an entire Multi-frame. In CCS31 mode channel 17 is a bearer channel not a signaling channel, and the alarms are valid only for channel 17 operating in signaling mode.</p> <p>The card no longer reports MFA alarms when operating in CCS31 mode.</p>
U801130009	<p>This is a new feature called Party Re-Answer added to 4xE1 capabilities. This is used in Singapore to allow the called party to hang up and go offhook again, without releasing the call. The called party has to go offhook within a certain time, otherwise the call is released. The call can also be torn down by the calling party as soon as it goes onhook.</p>
U802050001	<p>When using a Telerouter on a VCO to provide NTT to NET5 protocol converter application, CAUSE IE for the DISCONNECT message is not propagated from one side of the cal to the other. Instead, the VCO always generates a predefined CAUSE IE of "Normal Cal Clearing" (80 90).</p>
U802090003	<p>This is an enhancement that allows the host application to output different category digits from a \$69 command as part of the MFCR2 call processing. This provides flexibility over defining each different category digit in a different Output Rule.</p>
U802090005 and U802130004	<p>Previously, several screens experienced a lockup problem after the EXIT_SCREEN or PREV_MENU keys were pressed. Once locked up there was no response to any key, and the screen timed out after 15 minutes. During the lockup all other Generic functions remained intact.</p> <p>There are now no screen lockups regardless of key input.</p>
U802100005	<p>The dbvers.tbl file in V4.2 PUN23 did not contain the latest version number for itself. When a database conversion was done, an unexpected report states that dbvers.tbl was converted Version 4 to Version 5. The number of records recorded for dbvers.tbl was also incorrect (one less than the actual number). Note that dbvers.tbl contains a value for the version number of every table in the database, including itself.</p> <p>There is no effect on the system from this error, but it could cause confusion.</p> <p>Now a database conversion will not report that any files were converted.</p>
U802130004	<p>See U802090005</p>
U802130005	<p>Systems using the enhanced \$67 command would experience reboots.</p> <p>This problem was not reproducible at Summa Four, but has been has corrected as a result of code analysis.</p>

TR #	Corrected Problems
U802180003	<p>When a 4xE1 card was added with its spans configured as CCS/31, time slot 17 was unavailable. It could be made available by manually P'ing it in from the maintenance menu.</p> <p>Time slot 17 is now available without manual intervention.</p>
U802230001	<p>Previously with an outbound PSTN port connected to a clear-channel port via \$6A and \$66 commands, no \$DA report was sent to the host following a switchover with the PSTN port going onhook.</p> <p>Now when a switchover is initiated and the PSTN port goes onhook, a \$DA report is sent to the host.</p>
U802240001	<p>During live upgrade while the switch is processing calls, after option F (switchover to ACT on the SBY side), the new active side (after switchover) rebooted. This has been fixed.</p>
U803020002	<p>Start/End record exhaust condition was seen during host initialization as the host sent a burst of commands to activate the ports and connect them using a \$66 command. The number of start and end records have been increased from 900 to 1600.</p>
U803110014	<p>Occasionally users experienced a problem where they could not go beyond the Main Menu, and that any attempt to use any one of the four options available on the Main Menu would then cause the user to be logged out. Once this condition occurred, both telnet and local console access would experience the same behavior. The switch did allow the user to log in, but did not allow access to any other menu beyond the Main menu.</p> <p>The logout and access denial no longer occur.</p>



---

# Section 2

# SYSTEM REQUIREMENTS

---

## 2.1 INTRODUCTION

This section provides a listing of system requirements for running Generic V4.2 FSR00 PUN 24. These requirements are divided into database, hardware, firmware, and software. Contact Summa Four, Inc. Technical Support at 1-800-9SUMMA4 for any site-specific information.

## 2.2 DATABASE CONFIGURATION

The VCO system is shipped to you with:

- the Generic software installed on the hard drive
- the licenses configured in the database
- the NBC-3 and DTG/DTG-2 cards configured in the database
- all cards physically installed inside the enclosure

*Appendix A* contains an overview of the steps you must follow to add and configure the cards in your system.

## 2.3 HARDWARE REQUIREMENTS

To operate V4.2, a system must be equipped with the following components:

### *System Controller*

- VME-147 System controller card (must have updated boot PROMs) or Combined Controller.
- CPU Transition Module (CPU-TM) or Storage/Control I/O module
- 8 MB 68030-based CPU (central processing unit)
- SWI Version A0AR

### *Storage Subsystem*

- SCSI interface hard drive, 42 Megabytes or larger
- 3.5" SCSI Interface Floppy Drive

### *Control Circuit Cards*

- NBC-3 card Rev C0GR (or later) or E0AR (or later)  
(Two NBC-3 cards are required for redundant systems; one NBC-3 for non-redundant systems.)
- BRC—Bus Repeater Card—*not required for VCO/20 systems*  
(A BRC is required for each expansion rack—one in slot 1 in non-redundant systems, one each in slots 1 and 2 in redundant systems. SDS and VCO/80 systems only.)

*Port Interface Cards*

- E1-PRI 120 Ω card Rev A0CR (or later)

*Service Circuit Cards*

- DTG/DTG-2—Digital Tone Generator  
(All systems require a tone card to provide a quiet tone to the network.)

*SNMP*

- Ethernet connection

If you are planning to use SNMP on your system, an SNMP network management application or platform is recommended. You will need an SNMP application to perform SNMP tests on your system. One alternative is to use the tools available with applications such as Hewlett Packard's OpenView™ or Sun Microsystem's Net Manager®.

The components listed in this section are installed in new systems prior to shipment.

For information on the NBC-3 card hardware requirements, see the *Technical Description: Network Bus Controller-3 (NBC-3) Card*.

## 2.4 FIRMWARE REQUIREMENTS

System firmware requirements common to all systems are listed in Table 2.1. Table 2.2 lists domestic (U.S.) firmware requirements. Refer to the technical descriptions in Volumes 3 and 4 of your hardware documentation set for firmware locations for each card. Instructions for removing and replacing firmware PROMS are contained in *Section 3* of this document.

*Notes:*

<sup>1</sup> *The firmware label applied by Summa Four may list only the last four digits of the checksum.*

<sup>2</sup> *The checksum for the NBC-3 LP125 is not given because the programming for this item is part of the NBC-3 download file and is included in the checksum for the NBC download file.*

**Table 2.1: Common Firmware Requirements**

Card	Firmware	Checksum <sup>1</sup>	Version	Location	Changed Since V4.2 FSR00 PUN 23?
North American Requirements					
BRC	BRC	00002412	2.01	U2	N
CPA	CPA	0000A7A2	1.03	U2	N



**Table 2.1: Common Firmware Requirements(Continued)**

Card	Firmware	Checksum <sup>1</sup>	Version	Location	Changed Since V4.2 FSR00 PUN 23?
CPU 8Mb	Boot Even	006E6CB3	4.04	U1	N
	Boot Odd	0086954F	4.04	U15	N
	VME147 1	5741B41F	2.44	U30	Y
	VME147 2	5741B42F	2.44	U22	Y
CPU 16Mb 33MHz	Boot Even	006E691D	5.00	U1	New
	Boot Odd	00866CBF	5.00	U15	
	VME147 1	5741B41F	2.44	U30	
	VME147 2	5741B42F	2.44	U22	
DID-2	DID-2	000010C3	1.41	U2	N
DRC-8	DRC	00009625	5.23	U2	N
DRC-24/48	DRC-2	00004241	3.08	U2	N
Drop & Insert	D&I	00A998F6	2.01	U9	N
DVC	DVC	000095BE	2.07	U2	N
E+M	E+M	0000D381	2.06	U2	N
E1-CAS	E1-CAS/MERC	0000F1C6	2.13	U23	N
	E1-CAS/R2	00002654	2.01	U23	N
	E1-31B	0000EF58	3.03	U23	N
	E1-CAS/R2 (No CRC4)	000EDF08	3.43	U23	Y
	CAS PROC	00001E78	1.04	U85	N
	32 CHAN SETUP	0000CDDE	1.00	U113	N
	GAIN/LAW PROM	000011D2	1.02	U45/53	N
IIRC-8	IIRC 8-PORT	00220D75	1.03	U2	N
IIRC-64	IIRC 64-PORT	00220DC1	1.03	U2	N
IIRC-128	IIRC 128-PORT	00220E0A	1.03	U2	N
MRC	MRC	0000EE80	3.08	U2	N

**Table 2.1: Common Firmware Requirements(Continued)**

Card	Firmware	Checksum <sup>1</sup>	Version	Location	Changed Since V4.2 FSR00 PUN 23?
MVDC-T1	Local Bus	000D373B	LP100A	U35	N
	Com Bus	00186169	LP101A	U19	
	Interrupt	000AE787	LP102	U75	
	PCM Interface	001748E3	LP103A	U107	
	Framer	0005FE2C	LP104	U76	
	Gain/Law	0005A153	LP105B	U49	
	T1 Clock	000BE051	LP106	U80	
	Gain/Law	00776220	—	U50	
	Boot PROM	0065B028	1.06	U10	
NBC-3 Card Rev C	LP122 SWI	00194974	LP122C	U66	N
	LP123 Counter	0018E096	LP123E	U13	
	LP124 Chip Select	000D7B43	LP124C	U12	
	LP125 Com Bus FPGA <sup>2</sup>	—	LP125C	U43	
	LP126 Com Bus EPLD	0005CED8	LP126B	U47	
	LP127 Mezzanine Add.	0006C919	LP127A	U105	
	Boot PROM	00F597BE	1.02	U4	
NBC-3 Card Rev E	LP141 SWI	0019204D	LP141A	U31	N
	LP140 Counter	00187206	LP140C	U73	Y
	LP139 Chip Select	000D4209	LP139A	U30	N
	LP125 Com Bus FPGA <sup>2</sup>	—	LP125C	U53	
	Boot PROM	00F597BE	1.02	U1	
SSC	Com Bus Control	00186169	LP101A	U24	N
	PCM Interface	00198315	LP130B	U76	
	Quad 9 to 1	0017878C	LP129A	U71/U70	
	Redundancy Control	0017F249	LP128A	U100	
	Substrate Matrix Control	000BB573	LP131	U31	
	Boot PROM	00400736	1.02	U10	

**Table 2.1: Common Firmware Requirements(Continued)**

Card	Firmware	Checksum <sup>1</sup>	Version	Location	Changed Since V4.2 FSR00 PUN 23?
SLIC-2	SLIC-2	000010B9	1.41	U2	N
SRC	SRC	0000E5C7	1.07	U2	N
T1	T1	00002BA5	1.26	U2	N
	T1 Aux Proc	00007125	1.00	U45	N
UTC-2 Rev A UTC-2 Rev B	UTC	0000F91E	6.00	U2	N
	UTC	0000ECF0	6.54	U2	N
4XT1/E1	4XT1/E1 68340 VIRT CM	00291041	1.08	U10	N
	4XT1 68302 ODD	00277AE4	1.14	U47, 93, 150, 185	N
	4XT1 68302 EVEN	00242750	1.14	U48, 94, 151, 186	N
	GAIN/LAW CCITT G.711	000FCD68	1.03	U25, 28, 67, 78, 120, 131, 158, 170	N
	PATH SETUP ROM	0000CDDE	1.00	U35, 86, 116,178	N
	4XE1 68302 ODD	00263E25	1.04	U47, 93, 150, 185	N
	4XE1 68302 EVEN	002313DD	1.04	U48, 94, 151, 186	N
International Requirements					
E1-PRI	E1-PRI FW Odd	00107584	1.04	U38	Y
	E1-PRI FW Even	000DB375	1.04	U39	Y
	E1-PRI 32 Chan Setup	0000CDDE	1.00	U113	N
	PCM Gain/Law	000011D2	1.02	U45/53	N
International Requirements (Continued)					
NET5	Net5 Odd	00105997	1.01	U38	N
	Net5 Even	000DA683	1.01	U39	N
PRI	PRI FW Odd	00107EA5	1.02	U38	N
	PRI FW Even	000DB30B	1.02	U39	N
	32 Chan Setup	0000CDDE	1.00	U29	N
	PCM GAIN/LAW	000011D2	1.02	U45/53	N

**Table 2.1: Common Firmware Requirements(Continued)**

Card	Firmware	Checksum <sup>1</sup>	Version	Location	Changed Since V4.2 FSR00 PUN 23?
PRI/N	Odd	00115CB1	1.09	U38	N
	Even	000DEE1D	1.09	U39	N
	32 Chan Setup	0000CDDE	1.00	U29	N
	PCM Gain/Law	000011D2	1.02	U45/53	N

**Table 2.2: Domestic (U.S.) Firmware Requirements**

Card	Firmware	Checksum	Vers.	Location	Changed Since V4.2 FSR00 PUN 23?
DCC	DCC	0000A575	2.02	U2	N
	LIN/PCM 0 DB	0000B9A2	1.00	U43	N
	LIN/PCM -3 DB	0000AB04	1.00	U44	N
	PCM/LIN Odd	0000AFA2	1.00	U33	N
	PCM/LIN Even	0000B736	1.00	U34	N
DTG/DTG-2	DTG-FW	000077AD	1.23	U2	N
	Tone Odd	00000078	2.04	U54	N
	Tone Even	00004217	2.04	U53	N

## 2.5 SOFTWARE REQUIREMENTS

Valid software checksums and versions for the Generic V4.2 FSR00 PUN 24 software are listed in Table 2.3. Valid software checksums and versions for optional products are listed in Table 2.4.

Use the Software/Firmware Configuration utility to identify the version and checksum of each software file installed on the system (refer to the *System Administrator's Guide* for more information). Generic software files are distributed across the installation floppy diskettes. Each optional software product is contained on a single floppy diskette.

**Table 2.3: V4.2 FSR00 PUN 24 Software Requirements**

Software Product	S/W Vers.	S/W FSR	Filename	Check-sum	File Vers.	Changed since V4.2 FSR00 PUN 23?
GENERIC PUN 24	4.2	00	GLOBALS.EXE	01546CA3	4.04	Y
			HOSTMGR.EXE	021F8518	4.04	Y
			SYSWD.EXE	00000000	4.04	N
			REDMGR.EXE	00F0D9A5	4.04	Y
			PERMGR.EXE	00000000	4.04	N
			NETMGR.EXE	02800094	4.04	Y
			SNMP.EXE	0503E583	4.04	Y
			INSTALL.EXE	0216CB1B	4.04	Y
			MVDCT1.DWN	00F2D33A	1.08	Y
			NBC.DWN	0108C8D1	1.07	Y
			SSC.DWN	006C84CB	1.00	N
			CPA.DWN	003079F3	8.09	N
			DVC.DWN	005ADA02	1.08	N
			IPRC.DWN	0022E1EA	1.04	N
			DTMF.DWN	00053D1A	2.02	N
			DNI.DWN	006EF8D7	1.01	N
			4XT1.DWN	00349052	1.49	Y
			4XE1.DWN	003773FA	1.39	Y
			VRTX OS	—	1.08	N
			IFX	—	1.11	N
			TNX	—	1.45	N

**Table 2.4: V4.2 FSR00 PUN 24 Optional Products Software Requirements**

Software Product	S/W Vers.	S/W FSR	Filename	Check-sum	File Vers.	Changed since V4.2 FSR00 PUN 23?
			Optional Product Release Note Reference			
ETHERNET	4.2	00	ETHERMGR.EXE	00007B0C	4.02	N
TELEROUTER	4.2	00	TELERTE.EXE	00007ADA	4.00	N
MOTOROUTER	4.2	00	MOTORTE.EXE	00007ADA	4.00	N
<b>ISDN Options</b>						
ISDN-NFAS	4.2	00	NFAS.EXE	00007B0C	4.03	Y
ISDN-PRI	4.2	00	PRI.DWN	0089FAF0	5.09	Y
ISDN-PRIN	4.2	00	PRIN.DWN	00927AA2	5.09	Y
NI-2	4.2	00	NI2.EXE	00007B0C	4.03	Y
NTTPRI	4.2	00	See NTTPRI Release Notes for Generic V4.2 FSR00			Y
NTDASS2	4.2	00	See NTDASS2 Release Notes for Generic V4.2 FSR00			N
DPNSS	4.2	00	See DPNSS Release Notes for Generic V4.2 FSR00			N
NET5	4.2	00	See NET5 Release Notes for Generic V4.2 FSR00			Y

---

# Section 3

## UPGRADING TO V4.2 FSR00 PUN 24

---

### 3.1 INTRODUCTION

This section describes the procedures for installing Generic V4.2 FSR00 PUN 24 on systems currently running Generic V4.0 FSR00.

*Note: Call Summa Four at 1-800-978-6642 if you are running a version of the Generic other than those listed above.*

**CAUTION:** This section provides detailed installation instructions for loading system software and upgrading hardware. Deviating from these instructions can result in lost data. Read all the material in this section prior to installing the software. If you encounter any problems during the installation, contact Summa Four.

To perform an upgrade of the system and/or optional software, you must take both redundant and non-redundant systems off-line for a brief period.

**CAUTION:** Upgrading to V4.2 on systems with any card other than the NBC-3 configured in slot 2 of the Master Port Subrack, can cause the CPU to crash during the reboot after the data base conversion is performed. There is also a potential risk that the database cannot be converted back to its original state after the CPU crashes.

To avoid this condition on redundant systems, verify that the redundant NBC-3 is correctly configured in slot 2 before you begin the upgrade. On a non-redundant system, verify that slot 2 is empty and not configured in the database.

### 3.2 REFERENCES

Before you install the software, make sure you are familiar with the material contained in this section. You may also want to refer to the following documents:

- *SDS and VCO Installation Manual*
- *Technical Description: Network Bus Controller 3 (NBC-3) Card*
- *Product supplements for optional software, including:*
  - *VCO V4.2 Management Information Base (MIB) Reference Guide*
  - *VCO V4.2 Management Information Base (MIB) User's Guide*
  - *TeleRouter Reference Guide*
  - *ISDN Supplement*
  - *Ethernet Supplement*
  - *DPNSS Supplement*
  - *DASS2 Supplement*
  - *IIRC Supplement*
  - *NI-2 Supplement*
  - *ISDN NET5*
  - *Japanese ISDN*
  - *Applicable country supplements*

### 3.3 OVERVIEW OF THE INSTALLATION PROCEDURE

To upgrade a system you must perform six tasks.

1. Database backup (Section 3.5)  
This is a precaution against any possible loss of data.
2. Hardware and firmware replacement (Section 3.6)  
Upgrade the NBC-3/DTG-2, the CPU card (and the PRI/N card if installing ISDN, NFAS, NI2, or NTTPRI).
3. System software installation (Section 3.7)  
Install the Generic and optional software.
4. Database conversion (Section 3.8)  
Update the database tables.
5. Install software on the B-side (Section 3.9)  
Redundant systems only.
6. Host software installation (Section 3.10)  
Install the MIB on your network management system.

Each of these tasks is organized as a separate section. Because redundant systems require software installation on both sides, and because the optional software varies from customer to customer, there will very likely be a slightly different path for each upgrade. If you follow the instructions sequentially and perform the tasks as they apply to your system, you will be assured of a successful installation.

As you perform the upgrade, note that task 3, system software installation, is more detailed because it also deals with optional software installation.

#### Determining File Sizes

Because of some variations in existing installations, you may have difficulty converting from your current database to V4.2 FSR00. To determine if this is the case, you need to know the size of several of your files. To determine the file sizes, use the Show Directory option in the Disk Utilities menu to display the files in the c:/dbase directory. The sizes of your files should match the file sizes in Table 3.1.



**Table 3.1: File Sizes**

Version Number	File Name					
	syscnfg.tbl	dbvers.tbl	card.tbl	port.tbl	resgroup.tbl	promptlb.tbl
V3.3 FSR00	2081	288	32046	93184	2016	1120
V3.3 FSR01	2081	288	32046	93184	2016	1120
V3.3 FSR02	2160	288	32046	93184	2016	1120
V3.3 FSR03	2160	288	32046	93184	2016	1120
V3.3 FSR04	2160	288	32046	93184	2016	1120
V3.3 FSR05	2160	288	32046	93184	2016	1120
V3.3 FSR06	2160	288	32046	93184	2016	1120
V4.0 FSR00	2160	288	32046	93184	2016	1120
V4.0 FSR01	2928	306	32046	158720	2016	1120
V4.0 FSR02	2928	306	32046	158720	2016	1120

If the size of any of these files does not match the size listed in Table 3.1, contact Summa Four Technical Support immediately. Failure to have technical support evaluate the file size inconsistency will result in problems converting your current database to the V4.2 FSR00 format.

If you are running a version of software that is not in Table 3.1, you should also contact Summa Four Technical Support. An engineer will determine if the size of your database is correct for the software version numbers that you are running.

## 3.4 WHAT YOU NEED

You need the following hardware, firmware, and software to do the installation. Make certain you have:

### Software:

- Five (5) diskettes labeled as follows:

VCO SYSTEMS V4.2 FSR00  
GENERIC  
DISK x OF 5

Note: The *x* is a number from 1 to 5. The number indicates the sequence in which the diskettes must be loaded when you install the generic software. Only Disk 1 contains the installation utilities.

- V4.2 Diskettes containing the installation utilities for any optional software packages, for example, TeleRouter, ISDN-NFAS and/or Ethernet, and the MIB supplemental Disk Files (optional) to install the MIB software on your network management system.

### Hardware:

- NBC-3/DTG-2 card, Rev C0GR (or later) or E0AR (or later)—two cards for redundant systems

### Firmware

- 68030 CPU PROMs, ODD and EVEN V4.03
- NBC-3 Card Boot V1.02

### Other

- Blank diskettes to back up the system database.
- System printer, so you have a printed record of the installation process.

For redundant systems, be sure you can connect a system console to both system controllers.

Depending on your equipment's arrangement, you can:

- Set up a separate system console for each controller (A- and B-side).
- Use an A/B transfer switch wired to both system controller CPU-TM front panels to switch access.
- Physically remove and reconnect the system console cable from one CPU-TM front panel to the other.

### 3.5 BACKING UP THE DATABASE

Back up the database prior to beginning this installation. Do not try to back up the system database during the installation or after replacing the hardware and firmware (as described in Section 3.6 of this procedure).

*NOTE: During normal system operation, use the Data Base Store functions on the Disk Utilities menu to back-up the system data base. For more information about the Disk Utilities menu, refer to your System Administrator's Guide.*

To back-up the system data base, follow these steps.

1. Sign onto the system and access the Maintenance menu. (Refer to Figure 3.1)

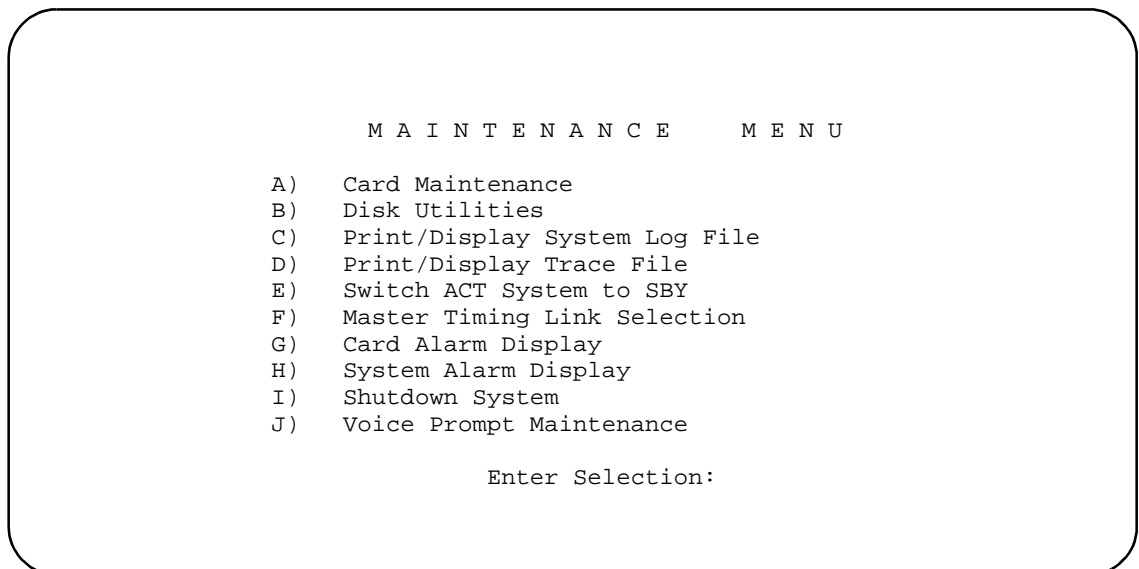

Figure 3.1: Maintenance Menu

2. Remove any diskette in the diskette drive on the A-side and insert a high-density diskette.
3. Type **B** to access the Disk Utilities, and press the **Return** key. The Disk Utilities menu appears (Refer to Figure 3.2.)

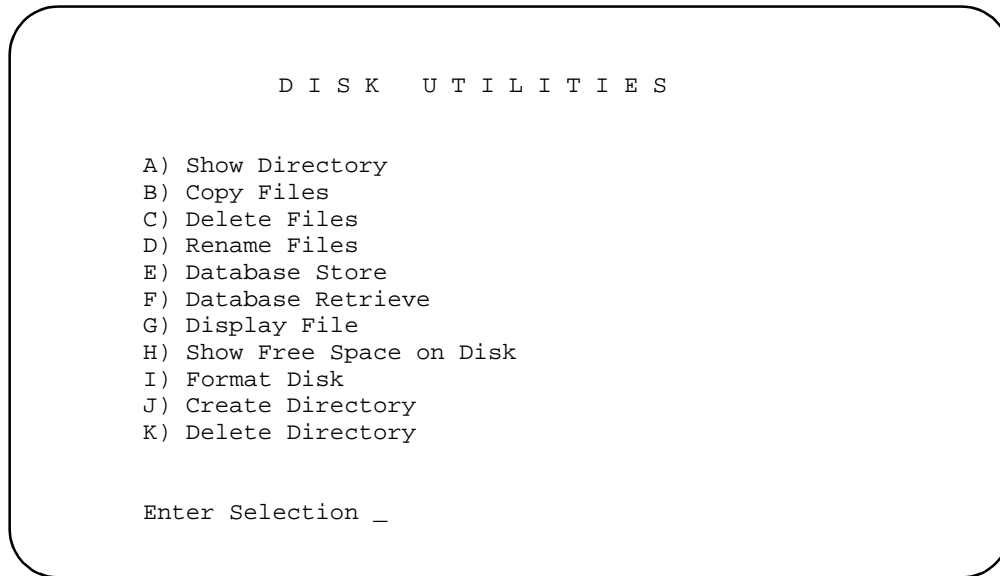

Figure 3.2: Disk Utilities Menu

4. a. To format the diskette, type **I** and press the **Return** key. The following message appears:

```
          F O R M A T   D I S K

Format What Drive? ____
Disk Volume Label? _____
Do Bad Sector Scan During Format <Y/N>? ____
```

The cursor is in the first field waiting for your response. Appropriate responses to the prompts are provided below:

Format What Drive?

Type **A**:  
then press the **Next Field** key.

Disk Volume Label?

This is optional. If you do not want to label the disk, press the **Next Field** key.  
If you want to label the disk, type in the label name and then press the **Next Field** key.

Do Bad Sector Scan During Format  
<Y/N>?

Type **Y**.  
This is optional. If you do not want to scan the disk for bad sectors, type **N**.  
*Note: This field is required and cannot be left blank.*

- b. A message appears to confirm your responses.  
For example:

F O R M A T   D I S K

Format Drive:

A:

OKAY TO FORMAT DISK? <Y/N>? \_\_\_\_

Type **Y** and then press **Enter**.

5. When the formatting is complete the Disk Utilities menu appears.
  - a. Type **E** for **Database Store** and press **Return**. The following message appears:

Ok to Store Database From C: to A: <Y/N>?
  - b. Type **Y** and press **Return**. A message at the bottom of the screen indicates the copying is taking place.
6. When the copy is complete, the message in Step 5 above reappears. Press **Exit** to return to the Disk Utilities menu.
7. Power down the system and continue to the next section.

*Note: If you use this backup diskette to restore the current data base after the upgrade, you will have to do a data base conversion after restoring. Refer to Performing a Data Base Conversion, in Section 3.8 on page 22. If you do not do the conversion after restoring from this diskette, the data base will not be compatible with the new version of software.*

### 3.6 HARDWARE AND FIRMWARE REQUIREMENTS

V4.2 requires upgrades in your system's current hardware and/or firmware. The upgrade depends on your current configuration. Please refer to *Table 3.2* and *Table 3.3* for information on the update requirements for your system.

The *Software/Firmware Configuration* screen displays the current checksums of the prompts on your cards. This screen is accessed from Card Maintenance. Refer to the *System Administration Guide* for additional information.

**Table 3.2: Upgrading Hardware & Firmware: Current Configuration**

Card	Note	Refer to:
CPU Card	You must update the firmware on the CPU card.	Section 3.6.4 — for the location of the firmware to be updated. Refer to Section 2 for checksum and version.
NBC Card	<p>V4.2 does not support the NBC card. If you currently have an NBC card, you must upgrade to the NBC-3 card.</p> <p><i>Note:</i> The new NBC-3 card supports the DTG-2 mezzanine card. Your system can operate with an NBC-3 card and your current DTG card, or with the new NBC-3/DTG-2 card combination. The NBC-3 card is a hot swap card: it can be removed and replaced while the system is powered up.</p>	<p>The <i>Technical Description: Network Bus Controller 3 (NBC-3) Card</i> in your hardware volume set — for instructions on installing the NBC-3 card.</p> <p><i>Note: If you are upgrading from the NBC card, make certain to following the removal instructions for the NBC card. Do not remove the NBC card while the system is in operation.</i></p>
NBC-3 Card (Rev C)	The NBC-3 card firmware must be updated.	Section 3.6.5 — for the location of the NBC-3 firmware to be updated Refer to Section 2 for checksum and version.

**Table 3.3: Upgrading Hardware & Firmware: New Cards**

New Card	Note	Refer to:
NBC-3 (Rev E)	<p>The new NBC-3 card supports the DTG-2 mezzanine card.</p> <p>Your system can operate with an NBC-3 card and your current DTG card, or with the new NBC-3/DTG-2 card combination.</p> <p>The NBC-3 card is a <i>hot swap</i> card: it can be removed and replaced while the system is powered up.</p> <p><i>Note: Depending on your configuration, the NBC-3 card may be a new card. Some customers may have already upgraded to the NBC-3. If you already have an NBC-3 card installed in your system, you need to update the firmware, (see Table 3.2). You may also opt to install the DTG-2 mezzanine card on your NBC-3 (refer to DTG-2 Card information in this table).</i></p>	<p><i>Technical Description: Network Bus Controller 3 (NBC-3) Card</i> in your hardware volume set — for instructions on installing the NBC-3/DTG-2 card.</p> <p><i>Note: If you are upgrading from the NBC card, be sure to follow the removal instructions for the NBC card. Do not remove the NBC card while the system is powered on.</i></p>
DTG-2 Card (optional)	<p>If you have an NBC-3 card, you may opt to purchase and install the DTG-2 mezzanine card on your current NBC-3.</p> <p>The DTG-2 is optional. Your system can operate with an NBC-3 card and your current DTG card, or with the new NBC-3/DTG-2 card combination.</p>	<p><i>Technical Description: Digital Tone Generator 2 Mezzanine (DTG-2) Card</i> in your hardware volume set — for instructions on installing the DTG-2 mezzanine card.</p>

### 3.6.1 Replacing Hardware and Firmware

The following describes the procedures for installing new firmware and programmable logic in circuit cards. Some of the procedures may not be applicable to this release depending on the upgrade.

Firmware is shipped in the form of programmable read only memory (PROMs), dual in-line packages (DIPs), integrated circuits (ICs) for through-hole mounting, and plastic leaded chip carriers (PLCC) for surface mount. Programmable logic is shipped in the form of programmable logic devices (PLDs), DIPs for through-hole mounting, and PLCCs for surface mount.

PROMs are labeled with configuration data which should be checked, prior to installation, against the firmware requirements contained in *Section 2*. PLDs are labeled with their LP identification number.

### 3.6.2 Removing and Replacing Through-Hole PROMs and PLDs

The following sections provide information about removing and replacing through-hole PROMs and PLDs. Refer to the appropriate technical description for the physical locations of the PROMs and PLDs on each circuit card.

#### Removing Through-Hole PROMs and PLDs

To remove a through-hole PROM or PLD, follow these steps.

1. If the circuit card is currently installed in the system, follow the removal and replacement procedures in the appropriate technical description. Be sure to also locate affected circuit cards kept as spares.

**CAUTION: Observe antistatic precautions near circuit cards. Wear a ground strap connected to the equipment frame whenever servicing or cleaning circuit cards (ground points are indicated by labels on the system front).**

2. Remove the PROM to be replaced from the circuit card. Use a PROM removal tool to grasp the integrated circuit and pull it straight up and away from the socket.

**CAUTION: Avoid using devices, such as screwdrivers, to remove PROMs. These devices can damage PROM pins and scratch the circuit card.**

3. Remove the PROM chip from the shipping package. Refer to *Section 2* to verify that the label on the chip matches the software requirements.

#### Replacing Through-Hole PROMs and PLDs

To replace a through-hole PROM or PLD, follow these steps.

1. Before installing the new chip, verify that its pins are all evenly spaced and vertically aligned. If necessary, align the IC pins properly prior to installation. To align the pins, you can either use a commercially available pin-straightener tool, sized for a 28-pin DIP device, or you can lay the PROM or PLD on its side and gently press the top edge, being careful not to press on the pins (Figure 3.3). Repeat this procedure for the other row of pins.



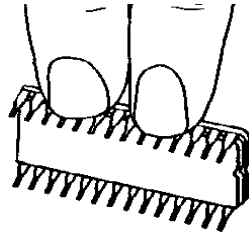

Figure 3.3: Aligning PROM or PLD Pins

2. Orient the PROM or PLD chip so that the notch in the chip (Figure 3.4) faces the notch on the circuit card.

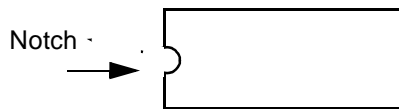

Figure 3.4: Notch Orientation for Integrated Circuit

3. Carefully insert the pins on one side of the PROM or PLD chip into holes on the correct side of the socket (see Figure C.5).

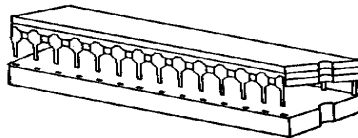

Figure C.5: Inserting Pins in One Side of Socket

4. Insert the pins on the other side of the PROM or PLD chip into holes on that side of the socket (see Figure C.6).

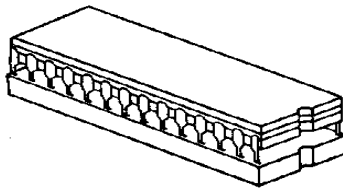

Figure C.6: Inserting Pins in Other Side of Socket

*NOTE: If the pins are not aligned with the socket holes, remove the PROM or PLD chip and straighten the pins (see Step 1). After realigning the pins, repeat Step 2 through Step 4.*

5. Carefully examine all the pins on the PROM or PLD chip. Be sure that none of the pins are bent or touching one another.
6. With all of the pins inserted into the socket holes, apply gentle and even pressure to the top of the chip until it is fully seated in the socket.
7. Re-install the circuit card in the system or return the card to spares stock.

### 3.6.3 Removing and Replacing Surface-Mount PROMs and PLDs

The following sections provide information about removing and replacing surface-mount PROMs and PLDs. Refer to the appropriate technical description for the physical locations of the PROMs and PLDs on each circuit card.

**CAUTION: Make sure you use the proper tool to remove surface mount PROMs and PLDs, or you may damage the board.**

#### Removing Surface-Mount PROMs and PLDs

To remove a surface-mount PROM or PLD, follow these steps.

1. If the circuit card is currently installed in the system, follow the removal and replacement procedures contained in the appropriate technical description. Be sure to also locate affected circuit cards kept as spares.

**CAUTION: Observe antistatic precautions near circuit cards. Wear a ground strap connected to the equipment frame whenever servicing or cleaning circuit cards (ground points are indicated by labels on the system front).**

2. Use the surface-mount chip removal tool, provided by Summa Four, Inc. to remove the PROM or PLD that is to be replaced on the circuit card. To remove the PROM or PLD chip:
  - a. Spread or compress the tool legs so the tongs fit into the slots of the chip carrier socket.
  - b. Insert the tool tongs into the slots of the socket, and push firmly so that the tool butts on the socket.
  - c. Place the thumb and forefinger on the tool's grip. Squeeze the thumb and forefinger together to remove the chip from the socket.

3. Remove the PROM or PLD chip from the shipping package. Refer to *Section 2* to verify that the label on the chip matches the software requirements.

### 3.6.3.1 Replacing Surface-Mount PROMs and PLDs

To replace a surface-mount PROM or PLD, follow these steps.

1. Before installing the new PLD, verify that the pins are all evenly spaced and properly aligned. If necessary, use tweezers to carefully align the IC pins prior to installation.
2. Align the notch or chamfered edge on the PLD to the silkscreened dot on the circuit card (see Figure 3.7).

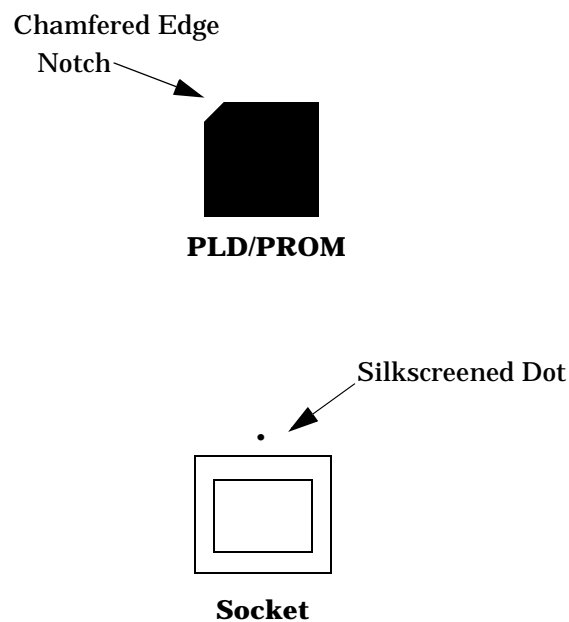

Figure 3.7: PLD Alignment

3. With all pins aligned to the pins of the socket, apply gentle, even finger pressure to the top of the chip until it is fully seated in its socket. This completes the installation of the surface mount chip.
4. Reinstall the circuit card in the system or return the card to spares stock.

### 3.6.4 Updating the CPU Firmware (68030 Processor)

You must update the EVEN (U1) and ODD (U15) PROMs on your CPU card. Refer to Section 2 for version and checksum information. The new firmware is included in your upgrade kit.

Refer to the *Technical Description: Central Processing Unit (CPU) Card* for the location of the PROMs that you need to update. The technical description also contains card removal procedures. The (Even) U1 and (Odd) U15 sockets are located next to the four LEDs on the CPU board and consist of 32-pin ICs. With the face plate towards you, these are the two left-most ICs of the four that are socketed on the board.

### 3.6.5 Updating the NBC-3 Firmware

If you currently have an NBC-3 card in your system, you must update the 40-PIN DIP, firmware on the card. Refer to Section 2 for version and checksum information. The new firmware is included in your upgrade kit.

Refer to the *Technical Description: Network Bus Controller 3 (NBC-3) Card* for the location of the firmware (U4 in the Rev C card, U1 on the Rev E card). The technical description also contains card removal procedures.

### 3.6.6 Updating the PRI/N Firmware

If you currently have a PRI/N card in your system, you must update the firmware on the card. Refer to Section 2 for version and checksum information. The new firmware is included in your upgrade kit.

Refer to the *Technical Description: Primary Rate Interface/NFAS Card* for the location of the firmware. The technical description also contains card removal procedures.

## 3.7 INSTALLING THE SOFTWARE

The following provides instructions for installing Generic V4.2 on systems currently running V4.0 FSR00 or later and V3.3 FSR00 through V3.3 FSR06. Installation procedures for Ethernet and optional software follow the Generic installation.

*Note: Call Summa Four at 1-800-978-6642 if you are running a Generic other than the above.*

On Disk 1, the Incremental Install Basic System Software option installs the Generic software and downloads files onto the hard disk. This selection does not format the hard drive.

*Note: Before continuing, make certain that you have completed your database backup and hardware/firmware replacement.*

The instructions in the following subsections assume that the system console is connected to the CPU-TM of the side being installed.

**CAUTION: Do not install the MIB - Supplemental Disk software on the switch. The MIB software is installed on the Host computer. Refer to Section 3.10, *Installing the MIB Software*. Do this after completing the installation of the Generic software on the switch.**

### 3.7.1 Installing the Generic Software

With the new hardware and firmware in place (Section 3.6), install the new Generic software on your system:

1. Insert Disk 1 into the floppy diskette drive (A-side if this is a non-redundant system, B-side if you are returning to this procedure to install software for that side).
2. Connect or switch the administration console to the A-side CPU-TM, or go to the A-side system console.
3. Power on the A-side.
4. After the system performs diagnostic tests, the Installation Utilities menu appears (*Figure 3.8*).

5. The cursor is located in the Enter Selection data entry field. Type **2**, (for Incremental Install of Basic System Software) then press **Return**.

The following message appears:

Do You Wish To Back-Up The System Data Base? (Y/N) =N?\_

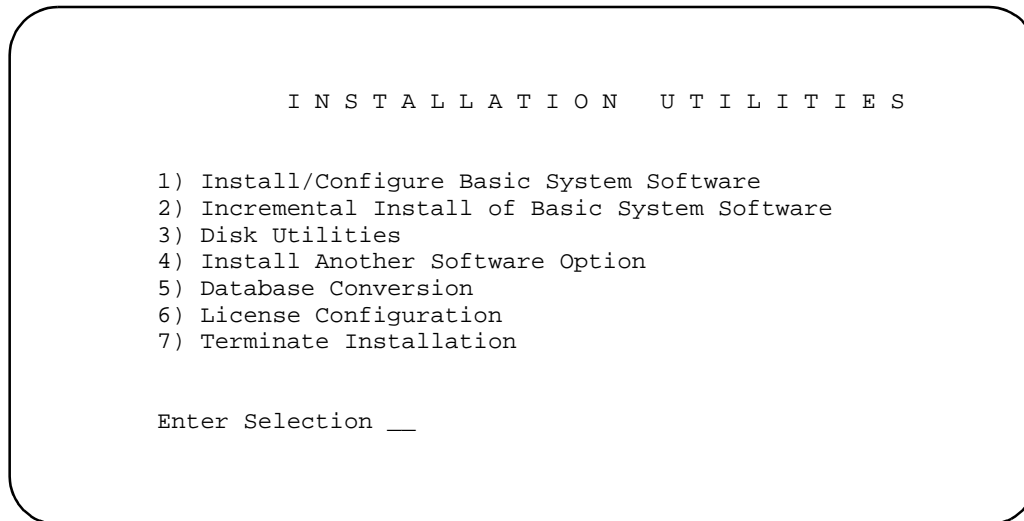

Figure 3.8: Installation Utilities Menu

6. Press **Return** (this defaults to N).  
The database will not be backed up at this time. Make certain that the database was backed up previously, as described in Section 3.5 of this installation procedure.
7. The following message appears:  

Insert disk 2 of Installation Set  
Press return to continue

Remove the current diskette from the drive, insert Disk 2, and press **Return**. The system copies the files from Disk 2 to the C: drive in the /BOOT, /DBASE, /LOG and /TRACE directories.
8. When all the files from Disk 2 are copied, the following message appears:  

Insert disk 3 of Installation Set  
Press return to continue

Remove the current diskette from the drive, insert Disk 3 then press **Return**. The system copies the files from Disk 3 onto the C: drive.
9. This pattern, of the system copying from the diskette then prompting for the next, continues until all five diskettes have been loaded and copied onto the system. Continue to remove and insert the installation diskettes when prompted to do so.  
  
When the installation is complete, the Installation Utilities menu appears again (*Figure 3.8*).

10. Optional software needs to be installed every time you update the Generic to ensure NVRAM update. For options such as TeleRouter, ISDN-NFAS, or Ethernet, type **4**, Install Another Software Option, then press **Return**.

The following message appears:

Insert Another Install Disk

Press Return To Continue

Instructions for installing Ethernet for the Host and SNMP communications are contained in the next section, Section 3.7.2.

*NOTE: When you install a software option (such as TeleRouter, etc.) on a system, the installation process makes changes to the nonvolatile RAM (NVRAM) on the CPU. These changes make operation of software options specific to the CPU on which you installed the options. For this reason:*

- *Software options must be installed on both system controllers in a redundant system.*
- *Software options must be reinstalled if the CPU is replaced. Although the data base information resides on the hard disk, a new CPU is unable to access this information.*

*Because of the reliability of the CPU, failures requiring replacement are very rare occurrences.*

If you are installing Ethernet, go to that section now. If you have other optional software to install after you have installed the Generic, see Section 3.7.3 for generalized installation instructions. More information on optional software installation is provided in the appropriate product supplement.

- a. If there is no Ethernet or optional software to be installed, continue to Section 3.8 to convert your database.

### 3.7.2 Installing Ethernet for Host and SNMP Communication

You can install Ethernet software as part of the generic software installation or separately. For complete installation instructions, refer to the supplement provided with the Ethernet software.

The following section provides generalized instructions for installing Ethernet optional software package. It is assumed that this step is being completed as part of the overall install and is being done as a continuation of *Installing the Software*.

To install and configure the Ethernet optional software, follow these steps:

1. Insert the Ethernet software diskette and press the **Return** key. After the system loads the Ethernet files from the diskette, the Ethernet Installation Utilities menu appears with the cursor located in the Enter Selection field (see Figure 3.9).

```
          I N S T A L L A T I O N   U T I L I T I E S

1) Install/Configure Ethernet Optional Package
2) Enable/Disable Ethernet Option
3) Disk Utilities
4) Install Another Software Option
5) Database Conversion
6) License Configuration
7) Terminate Installation

Enter Selection _
```

Figure 3.9: Ethernet Installation Utilities Menu

2. To install and configure the Ethernet software, type **1** and press **Return**. The following message appears:

Do You Wish To Back-Up The System Data Base? (Y/N) =N?\_

Press **Return** (this defaults to N). You will not be backing up the data base at this time. Data base backup should have been done in Section 3.5 of this installation.

The Ethernet Configuration menu appears (see *Figure 3.10*).

```
          E T H E R N E T   C O N F I G U R A T I O N

1) Install Ethernet Options
2) Edit Ethernet Parameters
3) Edit SNMP Management Station Parameters
4) Edit NFS Parameters
5) Edit Gateway Routing Table Parameters
6) Exit Ethernet Configuration

Enter Selection 1
```

Figure 3.10: Ethernet Configuration Menu

3. Type **1** and press **Return**. The following message appears:

Copy A:/BOOT/ETHERNET.EXE

1 files(s) copied

Ethernet Option Enabled



4. To set the Ethernet Parameters, type **2** and press **Return**. The following message appears:

System Internet Address = 107.3.254.98?

*Note: The Ethernet and Internet address numbers that you see in the screen messages in this section are only examples. In your system these numbers are replaced by numbers that represent your system addresses.*

5. Set the Internet Address of this system and press **Return**.

Set System Internet Address To 107.3.254.98 (Y/N) =Y?

6. If you change the address, you are prompted to confirm your new address. Type **Y** to confirm your selections. The following confirmation message appears:

System Internet Address Configured

7. Set the System Subnet Mask, or press **Return** to accept the displayed value.

After you complete this step, you can connect a remote console to your system via Telnet.

8. a. If you are *not* going to manage this system with SNMP, go to Step 14.  
b. If you *are* going to manage this system with SNMP, type **3** and press **Return** to set the SNMP Management Station Internet address. The following message appears:

SNMP Management Internet Address = 0.0.0.0?

9. Set the Internet address to the address of the system that you are using as the NMS (Network Management System). Press **Return**. The following message appears:

Set SNMP Management Internet Station Address To 189.7.107.44 (Y/N) =Y?

10. Type **Y** to confirm your selections. The following confirmation message appears:

SNMP Management Station Internet Address Configured

After you complete this step, the system will report SNMP trap messages to the NMS that you selected.

11. a. If you are not going to boot your system over the network, go to Step 14.  
b. If you are going to boot your system over the network, continue with Step 12.

12. Type **4** to set the Network File System (NFS) server parameters. The following selections appear one at a time. Enter the information for your system. Type **Y** and press **Return** after each selection.

Enable NFS Access (Y/N) =Y?  
NFS Server Internet Address = 000.0.000.000?  
NFS Server Name =xxx?  
NFS Mount Directory Point #?  
Target System Name =  
Target System User Id =  
Target System Group Id =  
Target System Umask =  
Update NFS Configuration With Above Data (Y/N) =Y?

13. After you update the NFS configuration with the new data, the following message appears:

NFS Configuration Updated

You can now save the log files and database to a remote location.

14. Type **6** to exit and press **Return**. The Installation Utilities screen appears (see Figure 3.9).
15. To end the Ethernet installation, type **7** and press **Return**.
16. Remove the Ethernet diskette from drive A.
17. If you have additional optional software to install, proceed to Section 3.7.3, *Installing Optional Software*, which follows.
18. If there is no optional software to install, proceed to Section 3.8, *Performing a Data Base Conversion*.

### 3.7.3 Installing Optional Software

You can install optional software as part of the generic software installation or separately. For complete installation instructions, refer to the supplement provided with the optional software.

The following section provides generalized instructions for installing an optional software package. It is assumed that this step is being completed as part of the overall install and is being done as a continuation of *Installing the Software*.

To install optional software, follow these steps:

1. Insert the optional software diskette and press the **Return** key.

If you are installing optional software such as TeleRouter or ISDN-NFAS, the optional software being installed appears in place of *Option Name* in choices 1 and 2 (*Figure 3.11*).

```

                                     I N S T A L L A T I O N   U T I L I T I E S

1) Install/Configure Option Name Optional Package
2) Enable/Disable Option Name Option
3) Disk Utilities
4) Install Another Software Option
5) Database Conversion
6) License Configuration
7) Terminate Installation

Enter Selection 1
```

Figure 3.11: Optional Software Installation Utilities Menu

2. To install and configure the optional software, type **1** and press **Return**. The following message appears:

```
Do You Wish To Back-Up The System Data Base? (Y/N) =N?_
```

Press **Return** (this defaults to N). You will not be backing up the data base at this time. Data base backup should have been done in Section 3.5 of this installation.

3. The following messages appears for most options:

```
Copying A:/Option Filename.EXE...
n file(s) copied
Option Name Option Enabled
```

4. If you are installing additional software packages, press **4**, (Install Another Software Option) and repeat the steps above.

5. After you install the last optional software package, type **3** and press **Return**. Proceed to Section 3.8.

### 3.8 PERFORMING A DATA BASE CONVERSION

Since the data base tables have changed, it is mandatory that you do a data base conversion. To do this, select option **5** in the Installation Utilities menu.

The conversion takes a few seconds. The following message is displayed on the screen:

Data base path for conversion: C:/dbase/

If the database does not need to be converted (i.e. it had previously been converted), no other messages are displayed. However, if you do convert the database, several other messages may be displayed. For example:

Converting the System Configuration table ...

This will take just a few seconds.

If you are upgrading a non-redundant system or you have finished installing software on the B-side of a redundant system, the upgrade is complete. Type **7**, Terminate Installation (refer to *Figure 3.11*), reboot the system, and proceed to Section 3.10, *Installing the MIB Software*.

If you are upgrading a redundant system, you can boot the A-side of the system (the side you have just completed upgrading) at this time to process calls. This is optional and can be done later, after you upgrade the B-side. Continue to the next section to complete the upgrade by installing software on the B-side.

### 3.9 INSTALLING THE SOFTWARE ON THE B-SIDE

If you do not have a redundant system, proceed to Section 3.10, *Installing the MIB Software*.

1. Connect or switch the administration console to the B-side CPU-TM, or go to the B-side system console.
2. Insert Disk 1 into the B-side drive.
3. Power on the B-side.
4. After the system performs diagnostic tests, repeat *Section 3.7, Installing the Software*, starting with Step 4 on page 8, to install the Generic software and optional software, and then Section 3.8, *Performing a Data Base Conversion*, on the B-side.

*NOTE: Make certain that you place the Installation Disks into the B: drive during installation of the B-side.*

5. After you have installed the software and converted the database on the B-side, type **7**, Terminate Installation (refer to *Figure 3.11*), place the ACC switch in Auto, reboot the system, and proceed to the next section to verify file synchronization.

### 3.9.1 Verifying File Synchronization

For redundant systems, after you have installed the software on both sides and rebooted the system, you must verify that file synchronization has occurred. Check the messages at the bottom of the screen until you see:

ACT FILE SYNC COMPLETED

*Note: This message may be replaced by subsequent messages before it can be seen. Check the active and standby log files to confirm completion.*

When file synchronization has been verified, the installation of system software is complete. Proceed to the next section to install the MIB software.

### 3.10 INSTALLING THE MIB SOFTWARE

If you use SNMP to manage your switch, install the MIB software on your network management system. See *Appendix C*.

This completes your upgrade to Generic V4.2.



---

# Section 4

## KNOWN DESIGN CONSTRAINTS

---

### 4.1 INTRODUCTION

*Note: No new design constraints have been introduced with the V4.2 FSR00 PUN 24 release.*

Summa Four, Inc. has identified and evaluated design constraints in Generic V4.2 FSR00 software, firmware, and hardware. This section provides explanations of, and where applicable, workarounds for, design constraints in the following areas:

- Upgrading to V4.2 on SDS and VCO/80 Systems
- Simple Network Management Protocol (SNMP)
- System Configuration Utilities
- Systems Considerations
- Software Exceptions on System Controller
- Card Initialization
- DTG-2 Card Alarms
- T1 Trunk Card Support
- Digit Collection
- Inpulse Rule Processing
- Resource Group Processing
- Conferencing
- MVDC-T1
- Operational Constraints
- Connecting to Modems
- IP Addressing

### 4.2 UPGRADING TO V4.2 ON SDS AND VCO/80 SYSTEMS

Upgrading to V4.2 on an SDS or VCO/80 system with any card other than the NBC-3 configured in slot 2 of the master port subrack, can cause the CPU to crash during the reboot after the data base conversion is performed. There is also a potential risk that the database cannot be converted back to its original state after the CPU crashes.

#### Resolution

To avoid this condition on redundant systems, verify that the redundant NBC-3 is correctly configured in slot 2 before you begin the upgrade. On non-redundant systems, verify that slot 2 is empty in the database before you begin the upgrade.

### 4.3 SIMPLE NETWORK MANAGEMENT PROTOCOL (SNMP)

The SNMP agent is designed to send a trap message on all alarms that would be reported to a host. Informational messages that are displayed on the system console are not sent as trap messages to an NMS.

The clearing of alarms matches the system configuration that you have set on the System Features screen. The alarm occurrence count is reduced when the alarm clears. There are no separate trap messages for clearing or setting alarms. Alarms are returned with a severity code. It is up to the Network Management System (NMS) to interpret and display the alarms.

### 4.4 SYSTEM CONFIGURATION UTILITIES

The following information applies to system configuration changes performed via the system administration interface.

#### 4.4.1 Peripheral Configuration Utility

The Peripheral Configuration utility allows you to define the communication parameters of the local and remote system administration interfaces. You must be careful to match the communication parameters (keyboard type, baud rate, etc.) to the requirements of the equipment you are using. If the configuration stored in the data base does not match these equipment or communication characteristics, the system cannot recognize keystrokes from the interface and system administration cannot be performed.

If this type of mismatch occurs, try the following steps:

- Modify the communication parameters at the interface end to match the configuration data stored in the system data base.
- Log into the system through another interface and modify the settings in the Peripheral Configuration screen. For example, if system administration is blocked on the Local TTY interface, log into the system remotely and change the settings.

If system administration access remains blocked on the interface, contact Summa Four Technical Support at 1-800-9SUMMA4.

#### 4.4.2 U611120001: Cannot Blank Out NFS Server Name

It is not currently possible to blank out the NFS Server Name when NFS File access is disabled.



## 4.5 SYSTEMS CONSIDERATIONS

### 4.5.1 U702240001: Timeout Waiting for Console Access

This is normal when the system is trying to display messages under heavy load conditions. These are diagnostic messages that serve only to indicate that the system is too busy to update the display on the Console, such as when attempting to update the clock time.

### 4.5.2 U702250006: Switchovers Cause Card Alarms with DTG-2

When performing a switchover with redundant DTG2s, FRM113 T1/E1 Remote Alarms are set and then cleared for all the cards in the system. This occurs when the DTG2 from one NBC switches to the other DTG2.

## 4.6 SOFTWARE EXCEPTIONS ON SYSTEM CONTROLLER

When a software exception (such as a bus exception or address exception) occurs on the active system controller, the Alarm Arbiter Card remains unaware of the problem for up to 20 seconds before initiating a system switchover. During the 20-second delay:

- there may be a loss in the voice path.
- a system outage occurs before the switchover to the standby controller.
- stable calls are not torn down and will be on the standby side.

The system recovers automatically (the controller reboots) unless the software exception was caused by a hardware failure. While a software exception on the active controller could greatly impair system performance, it is an extremely rare occurrence.

## 4.7 CARD INITIALIZATION

Cards request initialization from the NBC-3 by sending a signal. Under normal conditions, a card is initialized by the NBC-3, and then comes into service. If the NBC-3 cannot initialize the card, the card continues to request initialization from the NBC-3, and its green LED is lit. This may happen under one of the following conditions:

- A card connected to the backplane does not come into service (possible card failure). Remove any Out of Service cards from the backplane.
- A card is in a slot and connected to the backplane but is not defined in the system data base. Remove the card from the backplane or define that card in the system administration Card Maintenance screen.
- A card is in a slot and connected to the backplane but is defined as an incorrect card type in the data base. Remove the card and replace it with the correct type or update the card definition in the data base by using the system administration Card Maintenance screen.
- A card is marked as Out of Service in the Card Maintenance screen. Change the card status or remove the card.

The green LED is lit in NBC-3s, DTG/DTG-2s, and BRCs operating normally in Standby mode. It is good system practice to remove any Out of Service cards from the backplane to optimize system performance and further guard against the conditions described in this section.

For more information on the Card Maintenance screen, refer to the *System Administrator's Guide*. For more information on removing cards from the backplane, refer to the *System Maintenance Manual*.

## 4.8 DTG-2 CARD ALARMS

The information that follows applies to systems equipped with DTG-2 Cards.

### 4.8.1 U612120002: Card Alarms for Missing DTG-2 Cards

All V4.0 systems that do not have DTG-2s installed on every NBC-3 will show a card alarm for the missing DTG-2s. You cannot delete the DTG-2 as a separate card from the NBC-3. Thus, these card alarms can not be eliminated when the switch doesn't have a DTG-2 installed on each NBC-2. The alarms do not hamper the switches' operation.

## 4.9 T1 TRUNK CARD SUPPORT

The information that follows applies to systems equipped with T1 cards.

### 4.9.1 Slip Conditions in T1-Channel Service Unit (CSU) Connections

T1 slips are known to occur if the T1 port is connected to a Channel Service Unit (CSU) and the current timing source is either internal or incoming. Slips should be less than 255 in a 24-hour period. If they exceed this threshold, a minor system alarm is set and a FRM114 message is sent to the printer and system logfile. The message identifies the location of the T1 card which has passed the slip limit. If this condition occurs, contact Summa Four Technical Support at 1-800-9SUMMA4. For information on setting the timing source, refer to the *System Administrator's Guide* for your system.

### 4.9.2 Slip Counts in Card Display Only Updated after 10 Seconds

Slip counts for T1 cards are updated every 10 seconds on the Card Display. When a T1 card is displayed, the slip count will not be accurate for the first 10 seconds. After the first 10 seconds, the fields are updated with the correct slip count and are maintained properly thereafter.

## 4.10 DIGIT COLLECTION

The following information applies to DTMF/MF digit collection. The type of collection (DTMF or MF) is specified where necessary.

### 4.10.1 Optimum DTMF Digit Timing (8-Port DTMF Cards Only)

DTMF receivers are optimized to detect digits with a 60ms on/off time (60ms of tone, followed by 60ms of quiet). As the digit on/off times decrease, digits within a collection string may be missed, resulting in erroneous digit collection reports. This condition applies to:

- DTMF Receiver Card (DRC) service circuits, eight port version only
- The on-board receivers on SLIC-2, DID-2, and UTC-2 interface cards

You should contact your network service provider(s) to determine the digit timing on circuits connected to the system.

### 4.10.2 Digit Collection Using Reenter/Clear Character (8-Port DTMF Cards Only)

When a one- or two-digit Reenter Character is used for DTMF digit collection with the 8-Port DTMF card, the first digit that follows that character must have an on/off time of at least 55ms. If the timer for this first digit is less than 55ms, it may not be detected by the system.

## 4.11 INPULSE RULE PROCESSING

The following information applies to values for Inpulse Rule tokens.

### 4.11.1 Timer Variations

All timers specified in seconds can vary in length up to  $\pm 1/2$  second. This variation affects the Inpulse Rule tokens TIM FIELD, TIM FDIG, TIM INTER, and WAIT TIME in addition to all timers set in the DTMF Digit (\$67) standard/enhanced and Speech Collection Control (\$6E) commands and segments. This behavior is most pronounced when the timer is set to a value of 1 or 2 seconds.

### 4.11.2 U412204829/TR 4829: TIM FDIG 15 On DRC-24/48

The DRC-24/48 does not support a first digit timeout of 15 seconds.

## 4.12 RESOURCE GROUP PROCESSING

### 4.12.1 Inserting a Port Into a Resource Group

Changes to resource group configurations during call processing are not recommended. If you insert a port into a group during call processing, the system may temporarily be prevented from hunting that group for ports. Commands that attempt to hunt from the group are returned with a \$1F (no available port in resource group) Network Status byte until the system resets the port data pointers.

#### Resolution

If you must add ports to a group during call processing, you can avoid this condition by adding the ports to the end of the resource group and changing the group's hunt type setting to "Rotary" while the ports are added.

## 4.13 CONFERENCING

### 4.13.1 Conference Call Timing Delay

When adding a large number (300-400) of ports to a conference call at the same time, you may see the following message: CP\_TX\_Q QUEUE UNDER CONFERENCE LOAD.

#### Resolution

Add a 100-millisecond delay between each conference command to add each call, and this error should not occur.

## 4.14 MVDC-T1

### 4.14.1 RAM Diagnostics

The MVDC-T1 skips the RAM diagnostics after it powers-up and after subsequent resets from the NBC-3 card. This shortens the diagnostic checking period and is normal operation for the card. Do not remove and reinsert the card.

#### Resolution

When you want to rerun RAM diagnostics or reinstall a new download, leave the card out for approximately one minute. This will ensure that the card will rerun the diagnostics.

## 4.15 OPERATIONAL CONSTRAINTS

### 4.15.1 Activating Multiple Spans Simultaneously

Multi-span cards can sometimes get into an improper state if the entire card is OOS and the administrator attempts to activate multiple spans at the same time. This is caused by the time delay imposed by the on-card diagnostics.

#### Resolution

You can avoid this by starting a single span first. Always activate span one first for the 4xT1 and 4xE1. You can activate any span first for the MVDC. Once the first span is active, you can activate the others without any problem.

### 4.15.2 U508295234/TR 5234: Adding Cards to End of Configured Data Base

Trying to add cards to the end of a configured data base may cause a problem. For example, if you assign 1576 ports out of the 1776 that were licensed, and you try to add a 64-port IPRC, the following error message may occur: NO AVAILABLE PORT MEMORY. This is caused by port fragmentation, which means that there are enough total ports, but they are not contiguous.

#### Resolution

Rebuild the data base to reallocate the ports in a contiguous block. Refer to *Appendix A*.

## 4.16 CONNECTING TO MODEMS

When you connect a modem to the Modem/TTY port on the serial port 2/TTY01, the modem must be configured for 8 Data Bits/Char. If the modem is configured for 7 Data Bits/Char, the system cannot be accessed remotely.

Also, the configuration of the remote terminal must match the Modem/TTY baud rate, parity, and stop bit parameters displayed on the Peripheral Configuration screen.



---

# *Section 5*

# *KNOWN FUNCTIONAL CONSTRAINTS*

---

## 5.1 INTRODUCTION

Summa Four, Inc. has identified and evaluated functional constraints in Generic V4.2 software, firmware, and hardware.

This section provides explanations and, where applicable, workarounds for functional constraints in the areas that follow:

- System Administration
- System Configuration Utilities
- Special Redundant Systems Considerations
- Disk Operations
- Digit Collection
- Inpulse/Outpulse Rule Processing
- Call Processing
- Command/Report Processing
- Initialization
- Network Bus Controller-3 (NBC-3)
- Digital Tone Generator (DTG) and Digital Tone Generator-2 (DTG-2)
- Four Span Cards
- Miscellaneous Card Issues
- Multiple Host Connections
- TeleRouter
- Simple Network Management Protocol (SNMP)
- Ethernet
- ISDN Issues
- International Issues

## 5.2 SYSTEM ADMINISTRATION

The constraints described in this subsection apply to system administration tasks performed from the System Administration console.

### 5.2.1 Functions Not Supported in SNMP

Not all system administration tasks are supported by SNMP. See *Section 5.17.1* for a list of the tasks not supported.

### 5.2.2 U507315154/TR 5154: Trace Files Do Not Close

Trace files do not close at the end of the calendar day unless you have disabled tracing. Therefore, if you enable tracing, and the date changes, the system continues to add trace data to the previous date's trace file.

### 5.2.3 U507315162/TR 5162: No Automatic Database Conversion

You may experience a problem if you inadvertently try to load a backup copy of an outdated database. The system does not detect the outdated database and does not automatically perform the database conversion.

### 5.2.4 U508295234/TR 5234: Adding Cards to End of Configured Data Base

If you try to add cards to the end of a configured data base, you may see the following message: NO AVAILABLE PORT MEMORY. This is caused by port fragmentation, which means that there are enough total ports, but they are not contiguous.

This could happen, for example, if 1576 ports are assigned out of the 1776 that were licensed, and you try to add a 64-port IPRC.

Resolution

Rebuild the data base to reallocate the ports in a contiguous block.

### 5.2.5 U512071001: Aux1 Alarm Not Set on System Alarms Display Screen

Aux1 alarms triggered by the hardware (i.e., power supply, fan unit, or ring voltage failure) are not displayed on the System Alarms Display screen. Therefore, remote users cannot determine if a major hardware alarm is set.

### 5.2.6 U604041001: IPRC Voice Prompt Maintenance

The following error message can occur when you add voice prompts for the IPRC card in the Voice Prompt Maintenance screen:

ERROR — Cannot Add Prompt Err = 780

You might have entered a bad directory path, or the file might not be in the location specified.

Resolution

Verify that you have specified the correct directory and path name.



### 5.2.7 U605010004: Keyboard Type is Reset During System Reboots

The administration console intermittently gets re-initialized when the system reboots. This causes the keypad to reset to Numeric, instead of Application, which is required by the Generic.

#### Resolution

To correct this condition on systems with VT220 consoles, complete the following steps:

1. From the login screen, press PF3. The Set-Up Directory menu appears.
2. Use the arrow keys to position the cursor in the General field and press ENTER. The General Set-Up Menu appears.
3. Use the arrow keys to position the cursor in the Keypad=Numeric field and press ENTER. The field toggles to Keypad=Application.
4. Press PF3 to save the setting and return to the login screen.

To correct this condition on systems with WYSE consoles, complete the following steps:

1. From the login screen, press PF3. The Set-Up Directory menu appears.
2. Press PF11 (Kbd2). The Keyboard2 Set-Up Menu appears with the cursor in the Keypad=Numeric field.
3. Press ENTER. The field toggles to Keypad=Application.
4. Press PF4 to save the setting and return to the login screen.

### 5.2.8 U610030003: FRM51 Error Reading Download

Occasionally a system boot displays "FRM51 Error Reading Download File-Code 0x7e Filename C:/boot/xxxx.dwn." The download proceeds normally. There is no error.

### 5.2.9 U611260002: Abort Button

Pressing the ABORT button on the system controller has no effect if the Ethernet option has not been installed.

### 5.2.10 U705050001: FTP Quote Command Inconsistent

The quote compress command requires a drive specification (c:), but the uncompress and the split commands do not use a drive specification.

### 5.2.11 U705050002: FTP Quote Join Command Error

The FTP command: quote join c:core1 c:core1.x?? does not work. The command results in the error: 500, Command not understood.

### 5.2.12 U705060001: Can't Set FTP Password on Standby Side

The standby side is not updated with FTP passwords entered on the active side. Additionally, you cannot add the FTP password on the standby side.

#### Resolution

Switch the standby side to active.

### 5.2.13 U708280004: Wrong size of dbvers.tbl Following Database Conversion

For software releases beginning with V4.0 FSR01, the dbvers.tbl file size should be 306 bytes. The correct file size occurs following a full installation, but following an incremental installation and database conversion, the file size may remain at 288 bytes. This has no effect on switch operation.

### 5.2.14 U803190001: IPRC Call Chain Corruption

Customers may experience call chain corruption leading to a system dump or reboot when they take an IPRC64 or IPRC128 out of service while its ports are involved in calls.

#### Resolution

Do not take an IPRC64 or IPRC128 out of service during call processing. If for some reason it becomes necessary to take the card out of service while calls are being processed, first P out all the ports (place all the ports in Maintenance Busy state from the Card Maintenance menu) of that particular IPRC. This will release the calls and will prevent the call chain corruption.

After IPRC card is activated, P the ports back in so they can be used.

## 5.3 SYSTEM CONFIGURATION UTILITIES

The constraints described in this subsection apply to system configuration changes performed through the System Administration console.

### 5.3.1 U301063881/TR 3881: Selective Tracing Does Not Work

Selective tracing does not work properly in the System Trace Configuration screen. When **Selected** is enabled and you specify only one or two ports for a card, the system displays trace data for all the ports on the card.

### 5.3.2 U411304788/TR 4788: Viewing Software Configuration on Floppy Disks

Avoid using the Software/Firmware Configuration screen to view the contents of floppy diskettes (device A:). This screen does not produce consistent information.

#### Resolution

To view the contents of a floppy diskette, use the Disk Utilities Show Directory function.

## 5.4 SPECIAL REDUNDANT SYSTEMS CONSIDERATIONS

The constraints described in this subsection apply to redundant systems only.

### 5.4.1 U406284594/TR 4594: Lost Class of Service Results in Command Failure

The class-of-service of a phantom port in a stable call is incorrect. This results in command failure when the system tries to disconnect the call. The problem occurs when the active controller changes while the call is stable and the call was set up with one controller and torn down with the other.

### 5.4.2 U606190001: System Host Configuration Update Problem

On redundant systems, when you change the System Host configuration, you may get the error, "Standby DB Update Error - Bad Record Count." When this error occurs, the changes made on the Active side do not get written to the Standby side.

### 5.4.3 U609170001: Prompt Libraries are Not Displayed on Redundant Systems

Prompt libraries added on the Active side of a redundant system are not displayed when you perform a walk through the database.

### 5.4.4 U701290006/U508191001: DVC \$9 Timeout on Transfer to Standby

When you insert a DVC, it intermittently fails the download. A \$9 timeout message is generated and also an FRM006 Transition From Standby To Active message. The system, however, does NOT change from Standby to Active.

Resolution

Reinsert the card or activate the card from the Card Maintenance screen.

## 5.5 DISK OPERATIONS

The constraints described in this subsection apply to actions involving the Disk Utilities.

### 5.5.1 U409224673/TR 4673: Database Utility Covers File Access Errors

If an error occurs in the disk operation when you use the Data Base Store or Data Base Retrieve commands (under File Utilities), no warning is displayed to indicate that all files may not have been copied correctly.

### 5.5.2 U505035026/TR 5026: Formatting a Floppy During Reboot

Attempting to format a floppy diskette while the system is downloading a card causes the system to reboot with the error "FRM506: Fatal Processing Error Due To - ALM002: Network Manager Failure (SA)."

Resolution

Wait until all cards are downloaded before formatting a floppy diskette.

### 5.5.3 U604121001: Mismatch between On-line and Diskette Disk Utilities

Files that are created with the diskette disk utilities and which have special characters in them, such as underscores, are not readable with the on-line generic disk utilities when the system is up and running.

## 5.6 DIGIT COLLECTION

The constraints described in this subsection apply to DTMF/MF digit collection. The type of collection (DTMF or MF) is specified where necessary.

### 5.6.1 TR 2274: Single Digit Collections (8-Port DTMF Cards Only)

Using single digit end flags while performing DTMF digit collection may result in misplaced or unreported digits. The receiver requires processing time to detect a digit string, report the string to the generic software, and then reset itself for another collection. Collecting single digits as start/end designators between larger strings can result in missed digits because the DTMF receiver does not have sufficient time to reset before the next digit is entered. This situation can be aggravated when the digit timing does not match the optimum timing of 60ms of tone followed by 60ms of quiet. DRC 24/48 port cards function properly.

#### Resolution

Collect and store incoming DTMF digits as a single digit string. Digit fields 1 through 4 can store up to 40 digits; the ANI field can store up to 20 digits. Digit strings are reported to the host in either a DTMF Digit (\$D1) report or as a segment in an Impulse Rule Complete (\$DD) report. Using these reports, the host application can parse digit strings into their functional groups, as required.

### 5.6.2 U507315157/TR 5157: Garbled MF Digit Reports Not Sent to Host

MF Digit (\$D0) reports indicating garbled digits are not sent to the host when the Impulse Rule performing the collection contains the reporting control tokens REP EACH or REP NEXT. The system sends an Impulse Rule Complete (\$DD) report informing the host that the Impulse Rule was aborted, but does not send a subsequent \$D0 report. All other conditions that cause an Impulse Rule to abort generate an additional report explaining the cause. If you use the reporting control token REP END in the Impulse Rule, the \$DD report correctly contains a \$D0 segment indicating that the MF digits are garbled.

If an Impulse Rule with a REP EACH or REP NEXT token aborts while performing MF digit collection without generating an additional report, assume that the digit collection is garbled.

### 5.6.3 U607290001: Reenter Character Disables DTMF Collection Timers

When a Reenter Character is entered as the first digit before the DTMF Collection Control (\$67) command's prompts finish playing, a DTMF Digit (\$D1) Report is not issued.

## 5.7 INPULSE/OUTPULSE RULE PROCESSING

The constraints described in this subsection apply to values for Inpulse Rule tokens.

### 5.7.1 U503234961/TR 4961: RELEASE Inpulse Rule Requires Resource Type

You must specify a resource type when you use the Inpulse rule token RELEASE. If you do not specify a resource (IPRC, MRC, DRC, DTG, or CPA), the RELEASE token has no effect.

### 5.7.2 U608140005: RELEASE DTG Token Does Not Work

The RELEASE Outpulse rule token does not release the DTG/DTG-2 and causes the system to log an error during Inpulse rule execution.

### 5.7.3 U511211001/TR 5009: Limited Support for RETAIN and RELEASE Token

The RETAIN token is supported for only the IPRC and DRC in the Inpulse rules, and only partially supported in the Outpulse rules.

The RELEASE token is supported in the screen manager for the resource types IPRC, MRC, DRC, DTG, and CPA, but not fully supported in the run time processing. There is also an inconsistency in that the resources DTG and CPA, are not relevant to the IP rules but are supported for the RELEASE token. Resources IPRC, MRC, and DRC are not relevant to OP rules, but are supported for the RELEASE token. It is not possible to add a resource type for only an IP or OP rule.

## 5.8 CALL PROCESSING

The constraints described in this subsection apply to call processing.

### 5.8.1 U407064606/TR 4606: DASS Ports Stuck in MAINT-NE State

DASS ports may become stuck in a MAINT\_NE state.

#### Resolution

Clear a port by deactivating it and then activating it with the Port control function of the Card Maintenance submenu. Or, take the card out of service and then reactivate it.

### 5.8.2 U410264726/TR 4726: After Switchover, SLIC OGT Keeps Ringing

If a SLIC ICT (Incoming Trunk) is telerouted to SLIC OGT (Outgoing Trunk), and the SLIC OGT is ringing during a switchover, the SLIC OGT does not stop ringing when the SLIC ICT goes back on hook.

### 5.8.3 U412014797/TR 4797: DASS Ports Getting Stuck in CP\_GUARD

When there are two inbound DASS2 pipes (30 ports each with the first 15 in and the second 15 out), the ports on the second pipe may become stuck in CP\_GARD. The system uses the second 15 ports when all 15 ports in the first pipe are busy. If this condition persists and the CO tears down layer 3, the ports become unusable and no inbound calls are sent.

#### Resolution

Clear a port by deactivating it and then activating it with the Port control function of the Card Maintenance submenu. Or, take the card out of service and then reactivate it.

### 5.8.4 U503064939/TR 4939: Ringing a Port that is Off Hook

This condition involves SLIC ports (when class of service is A2) that go on-hook after every call. On an incoming call, a \$72 command is sent to seize and ring the port. Subsequently, a \$69 command is sent with Outpulse Rule 0 to connect the port to the incoming call. However, these two commands cause the port's ringer toggle bit to become out of synch (i.e., the \$69 command toggles the bit in an attempt to ring the port), which is already ringing as a result of the \$72 command. As a result, the ports ring when they should not, and do not ring when they should.

### 5.8.5 U503284968/TR 4968: Disconnect Fails Unless Port Goes Through Stable

A voice path must be established between incoming and outgoing ports (both ports are CP\_STAB) in order for those ports to successfully disconnect.

### 5.8.6 U505085035/TR 5035: Multiple Host and High Load Causes System Failure

Using an Ethernet system /Host interface with up to four hosts and high loads may cause the system to fail. Higher loads may support even fewer host connections.

### 5.8.7 U505115041/TR 5041: Interval between Seizure and Wink

One of the fields in Trunk Timing configuration is the Wink Send. For E1, this is the time period of the delayed dial signal. Tests have shown that this is about 60ms as opposed to the 30ms stated in the specifications.

### 5.8.8 U703280005: DRC Attach Time — 70ms Longer

The DRC attach time is ~70ms longer in V4.X than V3.3.

## 5.9 COMMAND/REPORT PROCESSING

The constraints described in this subsection apply to all host-issued commands and received reports.

### 5.9.1 U505105037/TR 5037: SIT Tone Detection Failure

The SIT tone for the North American DTG and CPA is not reported correctly. The SIT tone (4C8) is reported as Dial Tone in the \$DA reports.

### 5.9.2 U507315159/TR 5159: Appending Digits via the \$67 Command

When appending an odd number of digits to a field, which already contains an odd number of digits, the last digit of the first string and the first digit of the last string are lost. Two zeros are added to the end of the string to provide the correct number of digits.

#### Resolution

To avoid this condition, use two digit fields for digit storage instead of appending digits to an existing field.

### 5.9.3 U507315160/TR 5160: Number of Digits to Collect (\$67 Command)

You can use the \$67 command to collect up to 40 digits. Specify the number of digits that you want to collect in the Digit Collection Control (byte offset 9) byte. Command processing does not currently check this value to verify that the number is less than 40. If you specify a number greater than 40, the system still attempts to collect only 40 digits. The command is not rejected with a Network Status byte value of \$2C, as would be expected.

#### Resolution

Specify 40 or less in the Digit Collection Control byte.

### 5.9.4 U507315161/TR 5161: Inpulse Rule Complete (\$DD) Report Processing

A \$DD generated when an Inpulse Rule aborts due to a CPA exhaust condition, does not correctly specify the cause for the abort. The report indicates that the rule aborted because no Outpulse channels were available (T = 1 in the Inpulse Rule/DVC Port byte offset 10). However, the CPA exhaust condition is identified, by a Resource Allocation (\$D6) report, which specifies a resource limitation for the CPA resource group.

### 5.9.5 U508175187/TR 5187: \$67 Command and Inpulse Rule—Digit Collection

When the caller enters digits, it appears that a combination of the \$67 command and Inpulse rule is being processed. The digits that are reported are the first three digits that the caller input. Those digits are reported in a \$DD report and are also stored in field 1.

A second collection command (via the Inpulse rule specified in the \$6A command) does not completely override the first collection command (in the \$67 command). The DRC collects only 3 digits and reports them to the host, per the \$67 command, but then stores those digits in field 1 per the Inpulse rule.

#### Resolution

Have the application remove the receiver attached with the \$67 command when the outgoing hangs up. Then send the \$6C, and then the \$6A to start the Inpulse rule.

### 5.9.6 U603210001: NSB 02 Returned for \$65 and \$49 Commands

A Network Status Byte of 02 (Invalid command function ID) is returned by the Subrate Path Control (\$65) Command when the \$65 command contains 82 destinations. The ISDN Port Control (\$49) Command also returns a Network Status Byte of 02 if the \$49 command contains between 258 and 261 bytes.

### 5.9.7 U703200001: \$91 Command to Save Prompt, Fills Disk

When the \$91 command is used to save a prompt from the IPRC it continues writing the prompt file until the disk is full.

### 5.9.8 U705010002: \$90 Command Changes Hook State

Unexpected \$DB and \$DD message are received when issuing the \$90 command. The \$DB messages indicate the ports looped back to the ports being P'd in and out, are going on and off hook.

## 5.10 INITIALIZATION

The constraints described in this subsection apply to system initialization.

### 5.10.1 U311104202/TR 4202: System Sends \$DC Report too Early

After a warm start, the system sends a (\$DC) report to start call processing before IPRC prompt downloading is complete.

#### Resolution

You can use the feature flag and not start call processing until the system receives a command from the host (\$C0 04) to send that command when the IPRC changes from Maintenance to Active.

## 5.11 NBC-3

The constraints described in this subsection apply to the NBC-3 card.

### 5.11.1 U704140001: Cards Not Downloading After DID

If the error message FRM341: NBC error - Comm Bus Interf- DID err is received, cards in the system may fail to come into service. This usually occurs because a card is in a slot that is not defined for that card. When this is the case, other cards, even if properly defined, may also fail to come into service because device polling is discontinued.

#### Resolution

Cards can be activated through the Card Maintenance screen, or polling can be reactivated by re-booting the system with the offending card removed.

Normally, a Device Identification (DID) signal is asserted on the Communications Bus by a card to request initialization from the NBC. The card is then initialized by the NBC and comes into active service. If the card fails to initialize, it continues to assert DID on the Communications Bus and its green LED is lit. This condition occurs when one of the following scenarios is true. The corrective action is listed for each case.

- A card in the backplane does not come into service (possible card failure). Remove any Out of Service cards from the backplane.



- A card is inserted into a slot that does not have a card defined for it in the system data base. Remove the card or define that card from the system administration Card Maintenance utility.
- A card is inserted into a slot and connected to the backplane, but is defined as an incorrect card type in the data base. Remove the card and replace it with the correct type or update the card definition in the data base from the system administration Card Maintenance utility.
- A card is marked a Out of Service in the Card Maintenance Utility. Change the card status or remove the card.

It is good system practice to remove any Out of Service card from the backplane to optimize system performance and further guard against the conditions above.

When NBCs, DTGs, and BRCs are in Standby mode, their green LED is lit.

## 5.12 DTG AND DTG-2

The constraints described in this subsection apply to the DTG and DTG-2 card.

### 5.12.1 U608140004: Problems with Tone Ports during Switchovers

If the fuse is blown on the DTG-2 and there are no active tone cards in the system during switchover, the following conditions occur:

- On VCO/20 systems, the Standby side fails when the system attempts to remove tone ports from call chains.
- On VCO/80 systems, the system hangs during file synchronization and you cannot access screens from the Standby side.

### 5.12.2 U610020003: DTG/DTG-2 Add/Delete during Outpulsing

If you add or delete a tone generator card while another tone generator is outpulsing, the switch may be unable to do further outpulsing and may even crash.

Resolution

Do not add or delete tone generator cards while the switch is processing calls.

### 5.12.3 U703120001: Deleting a DTG from the Database Stops Outpulsing

If you delete a DTG from the data base in an active system, outpulsing ceases. This occurs even when there is no DTG physically present but there is a working DTG-2 available.

Resolution

A system reboot, or a system switchover to the other side, restores normal operation of the DTG-2. A switch back (after the switchover) to the first side will continue to operate normally.

## 5.13 FOUR SPAN CARDS

The constraints described in this subsection apply to the MVDC-T1 and Four Span T1/E1 cards.

### 5.13.1 U507201007: Processing WINK Command

When the Four Span T1 is configured as FX0-LX, the card processes a WINK command after it seizes out.

#### Resolution

Do not use a WINK in an Outpulse rule when Four Span T1 cards are configured as FX0-LX.

### 5.13.2 U603151001: Inconsistent Handling of Channels on Four Span E1

With Four Span E1 cards, resource groups can include channel 17, depending on whether the card spans are provisioned for CCS/31B or CAS. In CCS/31B mode, channel 17 is a bearer channel and can be added to a resource group. In CAS mode, channel 17 is used as the D-channel, and therefore, cannot be in a resource group.

After a Four Span E1 card is added and configured, you can change the mode from the Resource Group Configuration screen. However, the system does not automatically remove channel 17 from the resource group when the mode is changed from CCS/31B to CAS, or automatically add channel 17 to the resource group when the mode is changed from CAS to CCS/31B. When the span is changed from CCS/31B to CAS, all call attempts on channel 17 fail, because channel 17 is no longer a bearer channel. When a span is changed from CAS to CCS/31B mode, bandwidth is wasted.

#### Resolution

Verify that resource groups properly reflect the nature of channel 17 when changing the mode of a Four Span E 1 card span between CCS and CAS.

*NOTE: The System Administration console and SNMP do not prevent users from configuring bearer-channel signaling and timing parameters for channels that are not truly bearer channels. This applies to channel 17 for CAS mode and channel 1 for both modes. (Channel 1 is used for framing.) Users may find this misleading, but it is harmless.*

### 5.13.3 U604260001: Testing Patterns from TTS-3 Analyzer Causes Errors

MVDC-T1 and Four Span T1/E1 cards perceive the test patterns from a TTS-3 Analyzer as incoming seizures and generate FRM373 (Internal Message Length Error) and FRM102 (Card MSG) error messages.

#### Resolution

Remove the test boxes before connecting the system to the network and processing calls.

### 5.13.4 U606101001: MVDC-T1s/Four Span T1s Generate FRM90 before Download

Multiple iterations of the FRM090 message (Card restored, card alarm cleared) are generated while MVDC-T1 and Four Span T1 cards are downloading, coming into service, and going active.

### 5.13.5 U606241001: Four Span T1/E1 Internal Errors During Boot

During the broadcast download cycle, Four Span T1 and Four Span E1 cards intermittently generate an internal error code 1. The broadcast download fails, but the system recovers and successfully performs a direct download to each card.

Resolution

None. This problem does not affect service.

### 5.13.6 U611140005: Problem with Four Span T1 on Switchover

If you change the mode on a Four Span T1 card from active to maintenance, and then to out of service, from the Active side of the system, the changes also occur on the Standby side. However, if you change the mode back to active from the Active side, the card stays in maintenance mode on the Standby side. If the switch changes over while this condition exists, calls are lost.

Resolution

From the Active side of the switch, change the mode back to out of service, to active, to maintenance, and then back to active. This causes the Standby side to change from maintenance to active mode.

### 5.13.7 U611250003: FRM523 Queue Overflow

The messages “FRM523 Queue Overflow, Data Lost” and “Data lost on Screen\_Msg Queue” may appear when the system broadcasts a download to a large number (14 or more) of MVDCT1 cards.

### 5.13.8 U611260001: Rotary Resource Group

If the outgoing Four Span T1 trunk resource groups are set to ROTARY search, the ports in the resource group get stuck in CP\_WTF SUP.

Resolution

Use CYCLIC search.

### 5.13.9 U704140004: Display ACTIVE while Downloading

Following a warm reset, the 4xE1 cards display ACTIVE while downloading.

### 5.13.10 U710290005: MVDC T1 Fails to Clear Alarms

When multiple MVDC T1 cards are installed in a subrack, some cards re-download after a warm restart. The cards finally clear alarms after the download is complete. Also, there are queue overflows with data lost on RED\_TX\_Q, SCR\_MSG\_Q, CP\_TX\_Q, and SNMP\_MSG\_Q.

### **5.13.11 U710300006: FXSGS Configuration Does Not Process All Calls**

When the AM2-D bulk call generator is configured as FXOGS, and the MVDC T1 card configured as FXSGS, only 50% of the calls are processed. After the first call, the ports stay in CP\_GARD, GD\_NORMAL mode. The next call from the load box hangs up the port. The MVDC T1 card sees 100% completions and the load box only sees 50% completions.

### **5.13.12 U710300008: Aborted Download Does Not Resume After Switchover**

In a redundant system, when a download is in progress and an Active to Standby switchover occurs, the MVDC download aborts on the previously Active side but does not resume on the new Active side.

### **5.13.13 U710310001: Display Card Data Screen Not Recording Slips**

The Display Card Data screen does not record slips. The system was forced to slip by changing the AM2-D bulk call generator from internal to LINE A. Slips are recorded at the load box but the slip count does not increase on the Display Card Data screen.

## **5.14 MISCELLANEOUS CARD ISSUES**

The constraints described in this subsection are miscellaneous card issues.

### **5.14.1 U409124662/TR 4662: UTC Firmware Causing T1 INIT Code F Error**

The UTC firmware does not initialize the serial port in order to disable it. This might cause T1 INIT CODE F errors. Summa Four recommends that all firmware be checked to make sure that the serial port is disabled.

### **5.14.2 U505105038/TR 5038: Reorder Tone is Not Reported/Detected (UK)**

The Call Progress Analyzer (CPA) in use in the UK does not detect the Reorder Tone from the Dial Tone Generator (DTG).

### **5.14.3 U507195126/TR 5126: A2 SLIC Stuck in CP\_OUTPULSE**

A SLIC permanently goes into a CP\_OUTPULSE if an A2 SLIC goes on-hook, even momentarily, before a call is routed to it. Subsequently, no hook flashes are reported for the SLIC.

### **5.14.4 U603021003: IPRC Load Problems with more than 22 Seizures**

Load seize on Inpulse rules with record and speak tokens at 22 seizures cause IPRC cards to go OOS.

#### 5.14.5 U604040002: IPRC Load Problem

If sixteen simultaneous seizures occur while the IPRC is recording and playing temporary prompts, on systems configured with MFCR2 and Four Span E1 cards, which use Call Associated Signaling (CAS) with CRC4 set to ON, the IPRC card goes out of service and causes the system to fail.

The IPRC also goes out of service and causes the system to dump and reboot when an Inpulse rule used to collect DTMF or MFCR2 digits is followed by an Inpulse rule used to record a prompt with the GOTO RULE or DO IRULE token.

#### 5.14.6 U608090005: Erroneous Minor Alarms on Four Span E1

Occasionally, the minor alarm LED (yellow) stays illuminated after the alarms are cleared on all spans of the Four Span E1 card. The Card Display screen correctly displays the alarms as cleared.

#### 5.14.7 U608140002: Remote Alarm Problems with DPNSS Ports

When a remote alarm occurs during a DPNSS to DPNSS call, the generic keeps the call in a stable state and while clearing the alarm, the port gets stuck.

#### 5.14.8 U609230005: Outgoing T1 Stuck in CP\_OUTPUL

Outgoing ports on Single Span T1 cards intermittently became stuck in CP\_OUTPUL after incoming seizures.

#### 5.14.9 U610110003: Subrate Switch Card Download Broadcast

Subrate Switch cards do not simultaneously download when you cold boot the system.

### 5.15 MULTIPLE HOST CONNECTIONS

The constraints described in this subsection apply to SDS/VCO systems connected to multiple hosts.

#### 5.15.1 U605091001: Major Alarm Not Set on Loss of Hosts

The system does not generate the following alarm when all external host connections are lost and TeleRouter has been enabled:

ALM011: No Hosts Available

If TeleRouter is disabled after being enabled, the alarm is still not generated unless a new Ethernet host is configured and all host connections are then lost.

## 5.16 TELEROUTER

The constraints described in this subsection apply to systems with the Telerouter option.

### 5.16.1 U606041001: TeleRouter \$D5 (Routing Action) Reports

Telerouter \$D5 (Routing Action) Reports do not appear in the system trace file, but they are sent to the host.

### 5.16.2 U606030001: Access of TeleRouter Routes

When a Routing screen is displayed, which shows all of the routes in a table, you cannot access the last two routes. The “D” and “C” commands will give an “Invalid Route” error. The “T” command will find “NO MATCH” even though the screen displays the route and pattern.

Resolution

Add the patterns “FFFE” and “FFFF” to the end of the route table.

## 5.17 SIMPLE NETWORK MANAGEMENT PROTOCOL (SNMP)

The constraints described in this subsection apply to SNMP operation.

### 5.17.1 Functions Not Supported

#### 5.17.1.1 V4.2 FSR00 PUN 24 Release

There is no SNMP support for Network Side NET5, the REORDER tone feature for Japanese networks, or for other V4.2 FSR00 PUN 22 or PUN 23 features.

#### 5.17.1.2 Management Information Base

The Management Information Base (MIB) does not support the functions on the following System Administration screens.

- Disk Utilities Menu
- Print/Display System Log File Submenu
- Print/Display System Trace File Submenu
- Set Up Path Submenu
- Conference Display Screen
- Service Circuit Test Utility Screen
- Test Port Card Screen
- Call Generation Ports Display Screen
- Call Progress Tone Monitor Screen
- System Trace Configuration Screen

In addition, the MIB does not support the Routing Statistics Display function on the TeleRouter screen.

### 5.17.2 U604241001: Card Activate Errors Not Returned in SNMP

You can activate a card through the System Administration console or through SNMP. In either case, when a card is activated and the card type does not match what's in the database, an error message appears on the System Administration console and in the log, but not in SNMP. This is because the MIB variable for the error status is not updated.

### 5.17.3 U606051001: Zero Value for hostRemotePort Not Accepted

If you assign the value of zero to the object host Remote Port, in SNMP, it will fail. This should not happen because zero is a valid value.

#### Resolution

Set the remote port field in the Host Configuration screen to zero on the System Administration console.

### 5.17.4 U606051002: Zero Value for hostType Not Accepted

Assigning the value of zero to the object hostType in SNMP causes the following error message:

```
hostType.2 Number: unused(1) = 'bad value'
```

Assigning the value of zero should clear all of the objects of the host configuration entry.

#### Resolution

Use the Select key on the system console to toggle through the hostType options and clear the fields on the screen.

### 5.17.5 U606061002: Adding Same Card in Resource Group Twice

If you inadvertently add the same card twice into a resource group through SNMP, and then delete it through the system console, the data base is corrupted.

#### Resolution

Never add the same card into a resource group twice.

### 5.17.6 U606201001: Configuring Hosts

When a new host is added to the host table through SNMP, the Host Alarm State is incorrectly set to OFF. This creates a problem because the switch does not allow a host to connect when the alarm state is OFF.

#### Resolution

Configure new host settings through the System Administration console.

*NOTE: SNMP can update existing host configurations successfully.*

### 5.17.7 U609170001: Prompt Libraries are Not Displayed on Redundant Systems

Prompt libraries added on the Active side of a redundant system are not displayed when you perform a walk through the database.

### 5.17.8 U606201002: Committing Changes to the Data Base

Changes to MIB objects accumulate in the system until the appropriate EntryStatus object is set to VALID. There is a limit on the maximum number of outstanding changes, and when the limit is exceeded, changes are discarded, and the following error messages appear on the System Administration console:

```
FRM340: CODE Error – adm_api.c, 516:    cannot grow queue: 416  
FRM340: CODE Error – adm_card.c, 795:    cannot buffer attr: 21
```

The limit is not easily quantifiable.

#### Resolution

Make changes to tables by periodically setting the EntryStatus to VALID (for example, every five to eight rows), depending on the number of attributes changed.

### 5.17.9 U606211001: Modifying TimingCard Objects

If masTimingSource has been defined as internal or external, SNMP incorrectly allows the user to modify masPrimaryTimingCardPhyAddr and masSecondaryTimingCardPhyAddr. A subsequent GET on masPrimaryTimingCardPhyAddr or masSecondaryTimingCardPhyAddr returns the value zero. (Zero is returned whether you modify the object or not.)

#### Resolution

Do not modify masPrimaryTimingCardPhyAddr or masSecondaryTimingCardPhyAddr when masTimingSource is internal or external.

### 5.17.10 U608130005: SNMP Resource Group Configuration Problem

If you use SNMP to configure resource groups on redundant systems, the port.tbl file gets corrupted and ports are missing from resource group.

### 5.17.11 U609170001: Prompt Libraries are Not Displayed on Redundant Systems

Prompt libraries added on the Active side of a redundant system are accessible via SNMP.

### 5.17.12 U609250016/U609250017: SNMP Modification Tables

(See also U609250018.) The following SNMP tables do not get updated:

- dtgCardTableLastModified, when you added or deleted an NBC-3 card
- nbcTableLastModified, when you deleted a DTG-2 card

### 5.17.13 U708140005: D&I Card Not Supported Via SNMP

Configuration of the Drop and Insert card can only be done via the admin console. SNMP support for this card will be added in a future release. Until this occurs, there may occur a log message upon switch start-up "FRM340: CODE Error - serv\_listupdater.cc,822: ERROR".



## 5.18 ETHERNET

The constraints described in this subsection apply to Ethernet.

### 5.18.1 U608080006: Problem with Ethernet Install

If you attempt to update the gateway routing tables before Ethernet is installed and enabled, the gateway routing tables get corrupted.

Resolution:

Install and enable Ethernet before you attempt to update the routing tables.

## 5.19 ISDN ISSUES

The constraints described in this subsection apply to PRI and PRI/N ISDN configurations.

### 5.19.1 U401054297/TR 4297: ISDN Ports Remain in DISC\_REQ State

If phantom-to-DASS port calls are set up and torn down periodically for all the ports on a card, the DASS ports may become stuck in a CP\_GARD, NORMAL, DISC\_REQ state. If this happens to only a few ports on a card (some ports remain idle), incoming call attempts from the PSTN fail and no indication of the call is received. Outgoing calls from the SLIC connect but the DASS ports remain in a CP\_WTSUP, O\_INITED state.

### 5.19.2 U707300002: SETUPACK Message Type missing; required for Overlap Receiving/ Sending

To set the switch up for ISDN Overlap Receiving or Sending, the switch needs to be configured with ISDN Message templates containing SETUPACK and INFO tokens. The INFO token was added in V4.0 FSR02, but the SETUPACK token was inadvertently omitted.

## 5.20 INTERNATIONAL ISSUES

### 5.20.1 U505125048/TR 5048 Chile CPA Does Not Detect any Tones

The Chile Call Progress Analyzer (CPA 8.51) used with the Dial Tone Generator (DTG 1.02) does not detect DIAL, BUSY, RING, and CONGESTION tones, and reports CPA Internal Errors (Code 44).

### 5.20.2 U505155052/TR 5052: Finland CPA Does Not Detect Tones

The Finland Feature Package (CPA 8.70 with DTG FW V1.00) does not detect tones. All tones are detected as Voice Detect and Voice Cessation.

### 5.20.3 U505165056/TR 5056: Colombia DTG Does Not Output Digits

The Colombia Dial Tone Generator (DTG V1.00) used with Call Progress Analyzer (CPA V8.70) does not output digits.

#### 5.20.4 U505255069/TR 5069/TR 5068: Colombia CPA Tone Detection Problems

The Colombia CPA (V19.02) detects the SIT (04D4) tone intermittently. SIT tone is detected as PAGER CUE, VOICE, and VOICE CESSATION tones. RING tone is detected only 60% of the time; REORDER tone 40% of the time. SPECIAL REORDER tone is not detected at all.

#### 5.20.5 U508075168/TR 5168: Multiple MFCR2 Cards with Colombia V19.02

When you add more than one MFCR2 board to a system running Colombia V19.02, some of the calls might fail to seize ports. Occasionally, the boards fail and need to be reset before they start working again.

#### 5.20.6 U803110013: Telnet Logout Locks Console

Users running Generic V4.2 FSR00 PUN24 may experience a telnet or console lockup when logging out of the administrative interface via a telnet session and then logging in again via the local console or via telnet. During the lockup you will be unable to enter keys or display anything.

If you experience this problem, wait 15 minutes for the automatic console time-out to occur. Following the time-out, return to the telnet window and enter one or more keys before logging back in via the console.

**Resolution:**

To prevent lockout, enter one or more keys (or press the Enter key twice) at the password screen within the telnet window before terminating the telnet session.

---

# Appendix A DATABASE CARD CONFIGURATION

---

## A.1 INTRODUCTION

This section contains an overview of the steps you must follow to add and configure cards in new systems. Note that new systems do not contain a database. The NBC-3/DTG-2 cards are the only cards in the database; all other cards must be added. Refer to the *System Administration Guide* if you need more details on the steps outlined below.

## A.2 DATABASE CARD INSTALLATION

To add and configure your system's cards, do the following.

### A.2.1 Add Cards to the Database

The first step when adding cards to the database, is to take a survey of the cards in your system. Note the physical location (in which slot) each card resides. The card location survey worksheets, included at the end of this appendix, may be used to complete this step.

If you want to change the location of the cards, do so before completing the survey and adding the cards to the database.

**Table A.1: Card Placement**

Card	VCO/20		SDS and VCO/80	
	Redundant	Non-redundant	Redundant	Non-redundant
NBC-3/DTG-2	Resides in slots 1 and 2	Resides in slot 1 <sup>a</sup>	Resides in slots 1 and 2 of the Master Port Subrack	Resides in slot 1 of the Master Port Subrack <sup>b</sup>
Combined Controller	Resides in slots 3-4, and 5-6	Resides in slots 3-4 <sup>a</sup>	(none)	
BRC	(none)		In the Master Port Subrack: it is suggested that it reside in slot 3 In Expansion racks: resides in slots 1 and 2.	In the Master Port Subrack: it is suggested that it reside in slot 3 <sup>b</sup> In Expansion racks: resides in slot 1
All other cards	Start in slot 7		In Master Port subrack: start in slot 5 In Expansion racks: start in slot 3.	In Master Port subrack: start in slot 4 <sup>b</sup> In Expansion racks: start in slot 3

<sup>a</sup> Slots 2, 5, and 6 must remain empty in non-redundant VCO/20 systems.

<sup>b</sup> Slot 2 of the Master Port Subrack must remain empty in non-redundant SDS or VCO/80 systems.

When you have a written survey of where the cards reside, do the following:

- Log on to the system, and from the Maintenance Menu screen, access the Card Maintenance screen.
- The NBC-3/DTG-2 cards are the only cards that should display for rack 1 level 1.
- Add all other cards to the database. Note that when you add a card, it is out-of-service (OOS).

You will activate the cards in the last step in this procedure.

Refer to the *System Administration Guide, Section 4*, for information on how to access the Maintenance screens, and for instructions on adding cards.

## A.2.2 Configure the Cards in the Database

From the Data Base Administration screen, access the Card Summary screen. Tab to the DISP CARD field for the card you want to configure, enter any character, and press the Enter key. A new screen appears for the selected card.

Enter the following data on a per port basis:

- port name (if needed)
- hardware type (trunk cards only)
- impulse rule to be executed as a default
- class of service (per port)

Refer to the *System Administration Guide, Section 2*, for information on how to access the Card Summary screen, and for instructions on configuring cards.

## A.2.3 Assign the Ports a Resource Group

From the Data Base Administration screen, access the Resource Group Summary screen. *This step is mandatory for service circuit cards.*

- Define the resource groups.
- Tab to the DSP field for the resource group to which you want to assign ports, enter any character, then press the Enter key. A new screen appears for the selected resource group.

Refer to the *System Administration Guide, Section 2*, for information on how to access the Resource Group Summary screen, and for instructions on assigning ports.

## A.2.4 Activate the Cards

Access the Card Maintenance screen and change the status of the card to *Active*.

Refer to the *System Administration Guide, Section 4*, for information on how to access the Card Maintenance screen, and for instructions on activating cards.

## A.3 CARD SURVEY FORMS

This section contains card survey forms that you can use to record the location of cards in your system. Note that there are different forms for VCO/20 and SDS/VCO80 systems. A generic (blank) form for SDS/VCO80 systems is also included for your use, as needed.

**Table A.2: Card Location Survey—VCO/20**

<b>Card</b>	<b>Location rack/level/slot (R/L/S)</b>	<b>Other—Configuration and/or Resource Group Notes</b>
NBC-3 or NBC-3/DTG-2	1-1-1	
NBC-3 or NBC-3/DTG-2	1-1-2 <i>(redundant systems only)<sup>a</sup></i>	
Combined Controller	1-1-3 1-1-4	
Combined Controller	1-1-5 1-1-6 <i>(redundant systems only)<sup>a</sup></i>	
	1-1-7	
	1-1-8	
	1-1-9	
	1-1-10	
	1-1-11	
	1-1-12	
	1-1-13	
	1-1-14	
	1-1-15	
	1-1-16	
	1-1-17	
	1-1-18	
	1-1-19	
	1-1-20	
	1-1-21	

<sup>a</sup> Slots 2, 5, and 6 must remain empty in non-redundant VCO/20 systems.

**Table A.3: Card Location Survey—SDS or VCO/80 Master Port Subrack**

<b>Card</b>	<b>Location rack/level/slot (R/L/S) Master Port Subrack</b>	<b>Other—Configuration and/or Resource Group Notes</b>
NBC-3 or NBC-3/DTG-2	1-1-1	
NBC-3 or NBC-3/DTG-2	1-1-2 <sup>b</sup> <i>(redundant systems only)</i>	
BRC	1-1-3	
	1-1-4	
	1-1-5	
	1-1-6	
	1-1-7	
	1-1-8	
	1-1-9	
	1-1-10	
	1-1-11	
	1-1-12	
	1-1-13	
	1-1-14	
	1-1-15	
	1-1-16	
	1-1-17	
	1-1-18	
	1-1-19	
	1-1-20	
	1-1-21	

<sup>b</sup> Slot 2 of the Master Port Subrack must remain empty in non-redundant SDS or VCO/80 systems.

**Table A.4: Card Location Survey—SDS or VCO/80 Expansion Rack (R1-L2)**

Card	Location rack/level/slot (R/L/S) Expansion Subrack	Other—Configuration and/or Resource Group Notes
BRC	1-2-1	
BRC	1-2-2 <i>(redundant systems)</i>	
	1-2-2 <i>(available in non-redundant systems)</i>	
	1-2-3	
	1-2-4	
	1-2-5	
	1-2-6	
	1-2-7	
	1-2-8	
	1-2-9	
	1-2-10	
	1-2-11	
	1-2-12	
	1-2-13	
	1-2-14	
	1-2-15	
	1-2-16	
	1-2-17	
	1-2-18	
	1-2-19	
	1-2-20	
	1-2-21	



**Table A.5: Card Location Survey—SDS or VCO/80 Expansion Rack (R2-L0)**

Card	Location rack/level/slot (R/L/S) Expansion Subrack	Other—Configuration and/or Resource Group Notes
BRC	2-0-1	
BRC	2-0-2 <i>(redundant systems)</i>	
	2-0-2 <i>(available in non-redundant systems)</i>	
	2-0-3	
	2-0-4	
	2-0-5	
	2-0-6	
	2-0-7	
	2-0-8	
	2-0-9	
	2-0-10	
	2-0-11	
	2-0-12	
	2-0-13	
	2-0-14	
	2-0-15	
	2-0-16	
	2-0-17	
	2-0-18	
	2-0-19	
	2-0-20	
	2-0-21	

**Table A.6: Card Location Survey—SDS or VCO/80 Expansion Rack (R2-L1)**

<b>Card</b>	<b>Location rack/level/slot (R/L/S) Expansion Subrack</b>	<b>Other—Configuration and/or Resource Group Notes</b>
BRC	2-1-1	
BRC	2-1-2 <i>(redundant systems)</i>	
	2-1-2 <i>(available in non-redundant systems)</i>	
	2-1-3	
	2-1-4	
	2-1-5	
	2-1-6	
	2-1-7	
	2-1-8	
	2-1-9	
	2-1-10	
	2-1-11	
	2-1-12	
	2-1-13	
	2-1-14	
	2-1-15	
	2-1-16	
	2-1-17	
	2-1-18	
	2-1-19	
	2-1-20	
	2-1-21	

**Table A.7: Card Location Survey—SDS or VCO/80 Expansion Rack (R2-L2)**

Card	Location rack/level/slot (R/L/S) Expansion Subrack	Other—Configuration and/or Resource Group Notes
BRC	2-2-1	
BRC	2-2-2 <i>(redundant systems)</i>	
	2-2-2 <i>(available in non-redundant systems)</i>	
	2-2-3	
	2-2-4	
	2-2-5	
	2-2-6	
	2-2-7	
	2-2-8	
	2-2-9	
	2-2-10	
	2-2-11	
	2-2-12	
	2-2-13	
	2-2-14	
	2-2-15	
	2-2-16	
	2-2-17	
	2-2-18	
	2-2-19	
	2-2-20	
	2-2-21	



---

# Appendix B

## RE-INSTALLING V4.2 FSR00 PUN 24

---

### B.1 INTRODUCTION

This section describes the procedures for re-installing Generic V4.2 FSR00 PUN 24 for users who want to re-build their system. The procedure described here is the older, conventional installation procedure. If the system is still operational, the Live Upgrade feature could also be used. See the *System Administrator's Guide* for detailed information on running Live Upgrade.

**If you are upgrading an earlier system see Section 3.**

**CAUTION:** This section provides detailed installation procedures for loading system software. Review the material in this section prior to installing the software. If you encounter any problems during the installation, contact Summa Four.

### B.2 REFERENCES

Before you install the software, make sure you read all the material contained in this section. You may also want to refer to the following documents:

- SDS and VCO *Installation Manual*
- Product supplements for optional software, including
  - VCO V4.2 *Management Information Base (MIB) Reference Guide*
  - VCO V4.2 *Management Information Base (MIB) User's Guide*
  - *TeleRouter Reference Guide*
  - *ISDN Supplement*
  - *ISDN NET5 Supplement*
  - *NTTPRI Supplement*
  - *Ethernet Supplement*
  - *DPNSS Supplement*
  - *IPRC Supplement*
  - *NTDASS2 Supplement*
  - *NI-2 Supplement*
  - *Applicable country supplements*

## B.3 OVERVIEW OF THE INSTALLATION STEPS

The following provides a brief overview of the procedure to reinstall Generic V4.2 FSR00 PUN 24 software on your system. The steps are explained in detail in Section B.5 through Section B.10.

### Installing the Software

- Install the V4.2 FSR00 PUN 24 Generic software on the A-side. Refer to Section B.5.
- After the Generic is installed, install Ethernet and optional software. Refer to Section B.6 and Section B.7.
- If installing on a redundant system: after installing the software on the A-side, install the software on the B-side. The procedure is the same as the A-side installation. Refer to Section B.8

### Time Slot Allocation

- If you have purchased additional time-slots, you must update the Time-Slot Allocation License so that the system recognizes the additional time-slots. Refer to Section B.8.

### Installing the MIB Files

- Install the MIB files on the host computer. Refer to Section B.10.

**CAUTION: Do not install the MIB–Supplemental Disk software on the switch. The MIB software is for installation on a network management station (NMS). Refer to the section The MIB–Supplemental Disk Files, for information on moving the MIB software on your NMS. Do this after completing the installation of V4.2 Generic software on the switch.**

## B.4 WHAT YOU NEED

You need the following software to do the generic software installation. Make certain you have:

- Five (5) diskettes labeled as follows:  
VCO SYSTEMS V4.2 FSR00 PUN 24  
GENERIC  
DISK x OF 5  
  
*Note: The x is a number from 1 to 5. The number indicates the sequence in which the diskettes must be loaded when you install the generic software. Only Disk 1 contains the installation utilities.*
- Diskettes containing the installation utilities for any optional software packages; for example, TeleRouter, ISDN-NFAS, and/or Ethernet.
- A system printer with paper that is powered on, so you have a printed record of the installation process.
- Time-Slot Allocation License for additional time-slots (optional).
- Diskette labeled: MIB - Supplemental Disk Files (optional).

For redundant systems, be sure you can connect a system console to both system controllers. Depending on your equipment's arrangement, you can:

- Set up a separate system console for each controller (A- and B-side).
- Use an A/B transfer switch wired to both system controller CPU-TM front panels to switch access.
- Physically remove and reconnect the system console cable from one CPU-TM front panel to the other.

## B.5 INSTALLING THE GENERIC SOFTWARE

The following is the procedure for installing the Generic V4.2 FSR00 PUN 24 on new systems.

**CAUTION: This procedure reformats the C: drive. If this is not a new system install, refer to *Section 3*.**

On Disk 1, the Install/Configure Basic System Software option installs the generic software and downloads files onto the hard disk.

*Note: Verify that the CPU firmware is at the version level noted in Section 2 before you proceed with the installation.*

The instructions in the following steps assume that the system console is connected to the CPU-TM of the side being installed.

To install the generic software on your system, do the following:

1. Move the AAC switch to the A position.
2. Insert Disk 1 into the A-side floppy diskette drive.
3. Connect or switch the administration console to the A side CPU-TM, or go to the A-side system console.
4. Power on the A-side.

After the system performs diagnostic tests, the Installation Utilities menu appears (Figure B.1), with the cursor located in the Enter Selection data entry field.

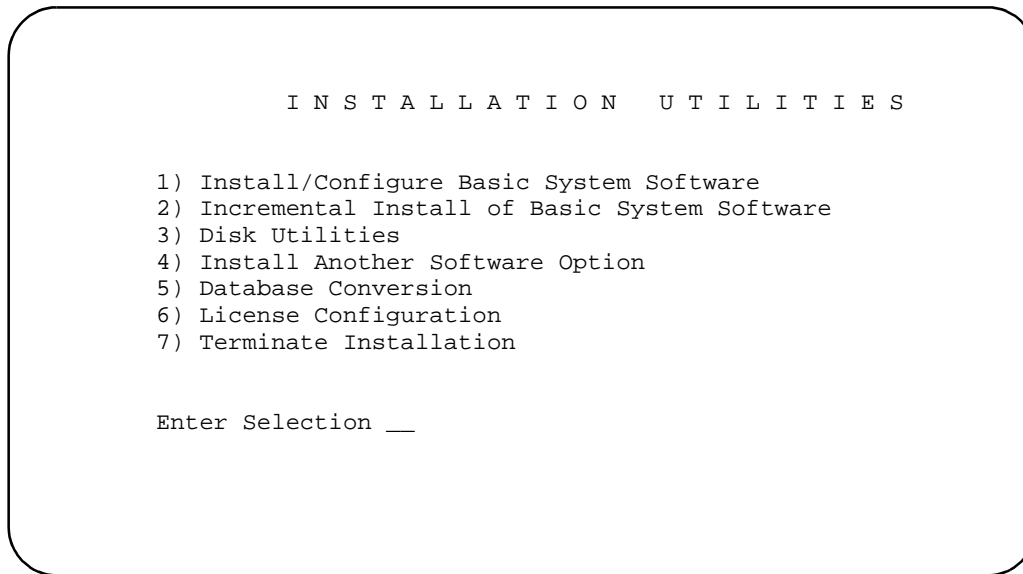

Figure B.1: Installation Utilities Menu

5. Do you want to reformat the hard drive?
  - a. If you do not want to reformat the hard drive, Type **2**. This will take you to Step 7, below.
  - b. If you want to reformat the hard drive, Type **1** (for Install/Configure Basic System Software), then press the **Return** key.

The following message appears:

Do You Wish To Back-Up The System Data Base? (Y/N) =N?\_

6. Press the **Return** key (this defaults to N).

If you are installing a new system it is assumed that there is no database to be backed up. If this is *not* a new system refer to, *Section 3 Upgrading to V4.2* included in these release notes, for instructions on installing V4.2 software on your system.

The following verification message appears:

The installation process reformats the device C:

All information will be erased

Press return to continue

Press the **Return** key to continue. The following message appears:

Formatting device C:

When complete, the following message appears:

Insert disk 2 of Installation Set

Press return to continue

Remove the current diskette from the drive.



7. Insert Disk 2 and press the **Return** key. The system copies the files from Disk 2 to the C: drive in the /BOOT, /DBASE, /LOG and /TRACE directories.
8. When all the files from disk 2 are copied, the following message appears:  
Insert disk 3 of Installation Set  
Press return to continue  
Remove Disk 2 from the drive, insert Disk 3 and press the **Return** key. The system copies the files from Disk 3 onto the C: drive.
9. When all the files from disk 3 are copied, the following message appears:  
Insert disk 4 of Installation Set  
Press return to continue  
Remove Disk 3 from the drive, insert Disk 4 and press the **Return** key.
10. Follow this procedure for all 5 disks. When the installation is complete, the Installation Utilities menu appears (Figure B.1).
11. a.) If you are *not* installing optional software, proceed to Section B.8 to install the software on the B-side.  
b.) If you have optional software packages to install, such as Telerouter, ISDN-NFAS, or Ethernet, type **4**, Install Another Software Option, then press the **Return** key.

The following message appears:

Insert Another Install Disk  
Press Return To Continue

Instructions for installing optional software after you have installed the Generic are provided in Section B.6, Installing Ethernet, and Section B.7, Installing Optional Software. The product supplement documentation also contains installation information.

Optional software needs to be installed every time you update the Generic to ensure NVRAM update.

*NOTE: When you install a software option (such as TeleRouter, etc.) on a system, the installation process makes changes to the nonvolatile RAM (NVRAM) on the CPU. These changes make operation of software options specific to the CPU on which you installed the options. For this reason:*

- *Install software options on both system controllers in a redundant system.*
- *Re-install software options if the CPU is replaced. Although the data base information resides on the hard disk, a new CPU is unable to access this information.*

*Because of the reliability of the CPU, failures requiring replacement are very rare occurrences.*

Proceed to the appropriate section.

## B.6 INSTALLING ETHERNET SOFTWARE FOR HOST AND SNMP COMMUNICATION

This section describes installation of the optional Ethernet software.

Install the software for SNMP trap message reporting and set up the network parameters by performing the following steps:

1. Insert the Ethernet diskette into the Side A drive and press the Reset button. After the system loads the Ethernet files from the diskette, the Ethernet Installation Utilities menu appears with the cursor located in the Enter Selection field (see Figure B.2).

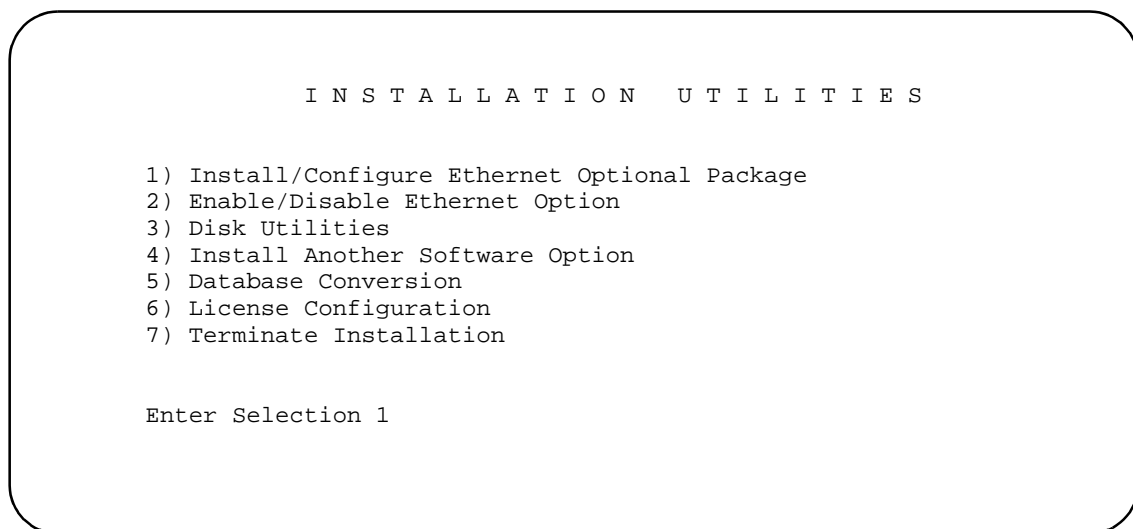

Figure B.2: Ethernet Installation Utilities Menu

2. Type **1** and press **Return**. The following message appears:  
Do You Wish to Back-Up the System Data Base (Y/N) =N?
3. Press the **Return** key (there is no data base to back up) and proceed to Step 4.  
The Ethernet Configuration screen appears (see Figure B.3).

```

                                     E T H E R N E T   C O N F I G U R A T I O N

1) Install Ethernet Option
2) Edit Ethernet Parameters
3) Edit SNMP Management Station Parameters
4) Edit NFS Parameters
5) Edit Gateway Routing Table Parameters
6) Exit Ethernet Configuration

Enter Selection:_
```

Figure B.3: Ethernet Configuration Menu

4. Type **1** and press **Return**. The following message appears:

```
Copy A:/BOOT/ETHERNET.EXE
```

```
1 files(s) copied
```

```
Ethernet Option Enabled
```

5. To set the Ethernet Parameters, type **2** and press **Return**. The following message appears:

```
System Internet Address = 107.3.254.98?
```

*IMPORTANT NOTE: The Ethernet and Internet address numbers that you see in the screen messages in this section are only examples. In your system these numbers are replaced by numbers that represent your system addresses.*

6. Set the Internet Address of this system and press **Return**.

```
Set System Internet Address To 107.3.254.98 (Y/N) =Y?
```

7. If you change the address, you are prompted to confirm your new address. Type **Y** to confirm your selections. The following confirmation message appears:

```
System Internet Address Configured
```

8. Set the System Subnet Mask, or press **Return** to accept the displayed value.

After you complete this step you can connect a remote console to your system via Telnet.

9. a. If you are not going to manage this system with SNMP, go to Step 15.  
b. If you are going to manage this system with SNMP, type **3** and press **Return** to set the SNMP Management Station Internet address. The following message appears:

```
SNMP Management Internet Address = 0.0.0.0?
```

10. Set the Internet address to the address of the system that you are using as the NMS. Press **Return**. The following message appears:

Set SNMP Management Internet Station Address To 189.7.107.44 (Y/N) =Y?

11. Type **Y** to confirm your selections. The following confirmation message appears:

SNMP Management Station Internet Address Configured

After you complete this step, the system will report SNMP trap messages to the NMS that you selected.

12. a. If you are not going to boot your system over the network, go to Step 15.  
b. If you are going to boot your system over the network, go to Step 13
13. Type **4** to set the Network File System (NFS) server parameters. The following selections appear one at a time. Enter the information for your system. Type **Y** and press **Return** after each selection.

Enable NFS Access (Y/N) =Y?

NFS Server Internet Address = 000.0.000.000?

NFS Server Name =xxx?

NFS Mount Directory Point #?

Target System Name =

Target System User Id =

Target System Group Id =

Target System Umask =

Update NFS Configuration With Above Data (Y/N) =Y?

14. After you update the NFS configuration with the new data, the following message appears:

NFS Configuration Updated

The log files and database can now be saved to a remote location.

15. Type **6** to exit and press **Return**. The Installation Utilities screen appears (see Figure B.4).
16. To end the Ethernet installation, type **7** and press **Return**.
17. Remove the Ethernet diskette from drive A.
18. If you have more optional software packages to install, proceed to Section B.7.
19. If this is the last optional software package and you have a redundant system, the V4.2 software must be installed on the B-side, refer to Section B.8, *Installing Software on the B-Side*.

## B.7 INSTALLING OPTIONAL SOFTWARE

The following section provides general instructions for installing an optional software package. For complete installation instructions refer to the supplement provided with the optional software.

To install optional software:

1. Insert the optional software diskette and press the **Return** key.

If you are installing optional software such as TeleRouter or ISDN-NFAS, the Installation Utilities menu specifies the optional software in place of *Option Name* in choices 1 and 2 (Figure B.4).

```
                I N S T A L L A T I O N   U T I L I T I E S

1) Install/Configure Option Name Optional Package
2) Enable/Disable Option Name Option
3) Disk Utilities
4) Install Another Software Option
5) Database Conversion
6) License Configuration
7) Terminate Installation

Enter Selection 1
```

Figure B.4: Optional Software Installation Utilities Menu

2. To install and configure the optional software, type **1** and press the **Return** key. The following message appears:

```
Do You Wish To Back-Up The System Data Base? (Y/N) =N?_
```

Press the **Return** key (this defaults to N.) There should be no data base to be backed up at this time.

The following messages appears for most options other than Ethernet:

```
Copying A:/Option Filename.EXE...
```

```
n file(s) copied
```

```
Option Name Option Enabled
```

3. If you are installing additional software packages, press **4** (to Install Another Software Option), and repeat the steps in this section.
4. After you install the last optional software package, type **7** and press the **Return** key. If you have a redundant system, the V4.2 software must be installed on the B-side, refer to Section B.8, *Installing Software on the B-Side*.
5. If you have purchased additional time-slots, refer to Section B.9 and to the *System Administration Guide*, for information about updating the license.

## B.8 INSTALLING THE SOFTWARE ON THE B-SIDE

If you are installing the software on a redundant system, you must also install the software on the B-side. If you do not have a redundant system, skip this section and go to the next section.

To install the software on the B-side:

1. Power down the system.
2. Move the AAC switch to the B position.
3. Connect or switch the administration console to the B-side CPU-TM, or go to the B-side system console.
4. Insert Disk 1 into the B-side drive.

*NOTE: Make certain that you place the Installation Disks into the B: drive during installation of the B-side.*

5. Power on the B-side.
6. After the system performs diagnostic tests, repeat the steps in *Section B.5, Installing the Software* starting with Step 5 and, if needed, *Section B.6, Installing Ethernet Software* and *Section B.7, Installing Optional Software*.
7. After the software has been installed on the B-side, power down the system, switch the AAC to Auto, and reboot the system.
8. Return to *Section B.9* and *Section B.10* to update your time-slot licence and to install MIB software.

## B.9 TIME-SLOT ALLOCATION LICENSE

If you have purchased additional time-slots, you must update the time-slot allocation license. Refer to the *System Administration Guide* for information about updating the license.

If no additional time slots were purchased, proceed to the next section, installing the MIB.

## B.10 THE MIB - SUPPLEMENTAL DISK FILES

Install the MIB software on your network management system. See *Appendix C*.

---

# Appendix C

## CONFIGURING THE MIB

---

### C.1 INTRODUCTION

This appendix describes the procedures for installing and setting up the MIB files that are on the Supplemental disk.

The MIB - Supplemental Disk contains four files with the following usage:

<b>vco.mib</b>	This file defines the structure of the MIB in ASN.1 notation. It is used for your implementation of network management on a workstation, PC, or other computer system.
<b>snmptalk</b>	This is a UNIX executable file which provides the user with the ability to send and get information from the database tables.
<b>mib.rt</b>	This file, used by snmptalk, is a translation of the vco.mib file. Snmptalk needs it to understand the mnemonics used to query the database tables.
<b>etc.ini</b>	This is the initialization file for snmptalk.

Use the MIB (vco.mib) application to send basic SNMP requests to the VCO for testing purposes and to demonstrate the basic structure of the SNMP agent.

The snmptalk® application is designed to be invoked on a Sun workstation using SunOS. The program uses files etc.ini and mib.rt. The file etc.ini contains configuration information; the file mib.rt contains information that enables you to enter symbolic information instead of numbers.

### C.2 INSTALLING THE MIB FILES

To move the MIB software which is provided on the MIB - Supplemental Disk to a network management system:

1. Place the MIB - Supplemental Disk in the floppy drive of the Host computer.

*Note that snmptalk is a UNIX executable file and is usable only on UNIX computers. The three other files can be used on a non-UNIX platform.*

2. Create a directory in which the MIB files are to reside. Define the location and name of the directory.
3. Move the files from the disk into the new directory created in Step 2.

*Note: All four files must reside in the same directory.*

### C.3 SETTING UP SNMPTALK

Once you invoke the `snmptalk` program, you need to enter the following set-up information so it can communicate with your system. Prior to doing the set-up, you need to know the Internet Protocol (IP) address of your system.

**Table C.1: snmptalk Setup Commands**

Command	Meaning
<code>v 1</code>	Use to select the SNMP Version 1 mode
<code>write-comm public</code>	Use to set write community to "public"
<code>dest nnn.nnn.nnn.nnn</code>	Use to enter the IP address of the VCO (where <i>nnn.nnn.nnn.nnn</i> is the IP address)
<code>?</code>	Use to provide a list of the commands available
<code>get sysUpTime.0</code>	Example of get command
<code>tset sysLocation.0 string here</code>	Example of set command
<code>quit</code>	use to exit program

*NOTE: This program cannot handle white space or quotes, so you must enter commands without spaces. This is a limitation of the basic test program.*

The `vco.mib` file is the ASN.1 notation MIB for the V4.2 system. This file can be compiled by a SNMP Network Management Station and used to provide the management station with information on the VCO MIB structure. The information in this file is also listed in the *VCO V4.2 Management Information Base (MIB) Reference Guide*.

#### C.3.1 Public Access

The community names for read and write access must be set to public for a NMS to properly access the Summa Four Enterprise MIB.