



# **User's Guide**

## **2000 and 1000 series**

### *Wireless Access Points for Ethernet*

Products supported:  
AP2000-E and AP1000-E

DOC-710-003848 Rev. A0

---

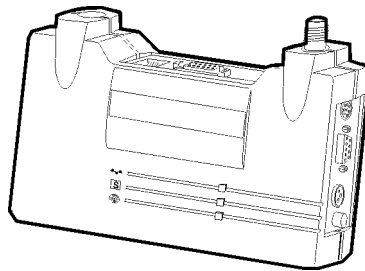

---

Aironet Wireless Communications, Inc. • 367 Ghent Road, Suite 300  
P.O. Box 5292 • Fairlawn, Ohio 44334-0292

**Aironet Wireless Communications, Inc.**

No part of this document may be reproduced or transmitted in any means, electronic or mechanical, for any purpose, without the written permission of Aironet. Information in this document is subject to change without notice. Aironet makes no representation or warranties with respect to the contents of this manual and specifically disclaims any express or implied warranties of merchantability or fitness for any particular purpose.

© 1997 Aironet Wireless Communications, Inc.  
All rights reserved.

ARLAN® & Aironet® are trademarks of Aironet Wireless Communications, Inc.

Printed in USA

DOC-710-003848 Rev. A0

**Manufacturers Federal Communication Commission  
Declaration of Conformity Statement**

**Models : AP1000-E, AP2000-E**

**Manufacturer :**

**Aironet Wireless Communications, Inc.  
367 Ghent Rd , Suite 300  
Fairlawn, OH 44333  
1-800-3-WIRELESS**



This device complies with Part 15 rules. Operation is subject to the following two conditions:

1) this device may cause harmful interference, and 2) this device must accept any interference received, including interference that may cause undesired operation.

This equipment has been tested and found to comply with the limits of a Class B digital device, pursuant to Part 15 of the FCC Rules. These limits are designed to provide reasonable protection against harmful interference when the equipment is operated in a residential environment. This equipment generates, uses, and radiates radio frequency energy, and if not installed and used in accordance with the instructions, may cause harmful interference. However there is no guarantee that interference will not occur. If this equipment does cause interference to radio or television reception, which can be determined by turning the equipment off and on, the user is encouraged to correct the interference by one of the following measures:

- Reorient or relocate the receiving antenna.
- Increase separation between the equipment and receiver.
- Connect the equipment into an outlet on a circuit different from which the receiver is connected.
- Consult the dealer or an experienced radio/TV technician.

**User Warning**

**The Part 15 radio device operates on a non-interference basis with other devices operating at this frequency. Any changes or modification to said product not expressly approved by Aironet could void the user's authority to operate this device.**

***Department of Communications - Canada  
Canadian Compliance Statement***

This Class B Digital apparatus meets all the requirements of the Canadian Interference-Causing Equipment Regulations.

Cet appareil numérique de la classe B respecte les exigences du Règlement sur le matériel brouilleur du Canada.

This device complies with RSS-210 of Industry of Canada. Operation is subject to the following two conditions: 1) this device may cause harmful interference, and 2) this device must accept any interference received, including interference that may cause undesired operation.

***European Telecommunication Standards Institute  
Statement of Compliance  
Information to User***

This equipment has been tested and found to comply with the European Telecommunications Standard ETS 300.328. This standard covers Wide-band Data Transmission Systems referred in CEPT recommendation T/R 10.01.

This type of accepted equipment is designed to provide reasonable protection against harmful interference when the equipment is operated in a commercial environment. This equipment generates, uses, and can radiate radio frequency energy, and if not installed and used in accordance with the instruction manual, may cause harmful interference to radio communications.

## ***Declaration of Conformity***

***Aironet Model Number:  
AP2000-E***

Application of Council Directive: 89/336/EEC  
Application of Council Directive: 72/23/EEC

CE Type Examination Certificate: HDTP/RDR/167/328880/11

Standards to which Conformity is Declared:  
EN 55022 (B)  
EN 55011 (B)  
EN 50082-1  
EN 60950

Manufacturer:  
Aironet Wireless Communications, Inc.  
367 Ghent Road, Suite 300  
Fairlawn Ohio, 44333

.....

*The undersigned hereby declares that the equipment specified  
above conforms to the directives and standards cited herein.*



*Michael Lomedy*

Director, Manufacturing Engineering  
Aironet Wireless Communications, Inc.

## Safety Information

The FCC with its action in General Docket 93-62, 1997, has adopted a safety standard for human exposure to radio frequency (RF) electromagnetic energy emitted by FCC regulated equipment. Aironet subscribes to the same safety standard for the use of its products. Proper operation of this radio according to the instructions in this manual will result in user exposure substantially below the FCC recommended limits.

- Do not move the AP1000-E/AP2000-E antenna(s) while the unit is receiving or transmitting.
- Do not hold any component containing a radio such that the antenna(s) is(are) very close to, or touching, exposed parts of the body, especially the face or eyes, while transmitting. Hold such a component 15 centimeters (6 inches) or more from your face.
- Do not allow children to play with any radio equipment containing a transmitter.
- Do not operate a portable transmitter near unshielded electrical blasting caps or in an explosive atmosphere unless it is a type especially qualified for such use.
- Do not turn on the AP1000-E/AP2000-E or attempt to transmit data unless the antenna(s) is(are) attached; if the antenna(s) is(are) not attached, the radio module may be damaged.

The AP1000-E/AP2000-E are compliant with ANSI C95.1.91 (1991).



## ***Table of Contents***

---

<b>Before You Start .....</b>	<b>1</b>
<b>Terminology .....</b>	<b>1</b>
<b>Understanding the Radio Network.....</b>	<b>2</b>
<b>Installing the Hardware .....</b>	<b>4</b>
<b>Configuring the Access Point.....</b>	<b>8</b>
Console Port.....	8
Telnet Session.....	8
System Identifier (SID) .....	9
Bitrate/Frequency (2000 Series/2.4 GHz Models).....	9
Channel (1000 Series/900MHz Models) .....	10
Root Mode.....	10
Verifying Registration .....	10
<b>Where to Go from Here .....</b>	<b>11</b>
<b>Technical Support .....</b>	<b>11</b>
Shipping Address .....	11
Communications .....	11
Web Site.....	11





*The purpose of this User's Guide is to allow you to install and configure your Access Point so that an end node or another Access Point (acting as a Repeater) will be able to register to it. For detailed installation and configuration procedures, see the AP1000-E/AP2000-E Technical Reference Manual.*

## ***Before You Start***

After unpacking the system, make sure the following items are present and in good condition.

- Wireless Access Point — 2000 or 1000 series
- 120VAC/60Hz or 90-264VAC/47-63Hz to 12-18VDC Power Pack
- Standard 2dB Dipole Antenna

If any item is damaged or missing, contact your Reseller. Save all shipping and packing material to repack the unit in the future, should service be required.

## ***Terminology***

**Root Unit** - An Access Point which is located at the top of a RF Network Tree. The Root Unit is the starting point in the network and contains information in its Registration Table regarding all nodes on the network.

**Repeater** - A Repeater is an Access Point which is used to extend the radio range of your RF Network. A single Access Point has a limited RF range. If your system configuration includes nodes outside this range, you will need to add a Repeater in order for them to communicate.

**Radio Node** - A PC, notebook computer, etc. containing a Wireless LAN ISA, MCA card or PCMCIA Adapter.

**End Node** - A Radio Node that is at the end of the RF Network Tree.

## ***Understanding the Radio Network***

Advanced Radio Local Area Network (ARLAN) is designed like an upside-down tree, with a Root Unit at the top, and repeaters and Radio nodes branching down and out from the Root as shown in the figure below.

Wireless Access Points can serve as a Root Unit or Repeater, providing wireless data communications between the Ethernet based network and other end nodes, or within the radio network itself.

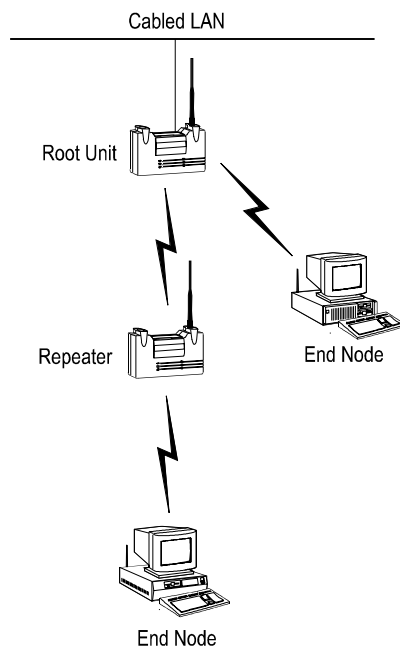

In the example shown, the Root Unit does not register, but will accept Registration from those nodes within Radio Range (The Repeater)

The Repeater registers to the Root Unit and will accept registrations from the End Nodes within radio range.

The Repeater will pass along the End Nodes' registrations to its parent, the Root Unit.

The Root Unit will have registration information for all nodes on the radio network in the tree.

*Optional long range antennas are shown below; a range of 6 miles can be achieved with the 900MHz Yagi and 4 Miles with the 2.4GHz Yagi.*

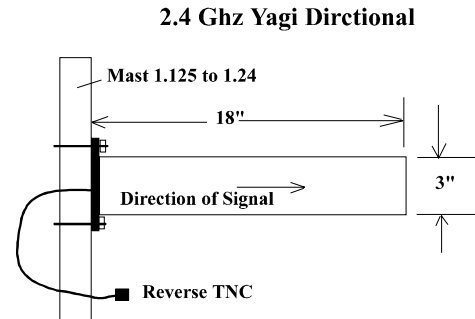
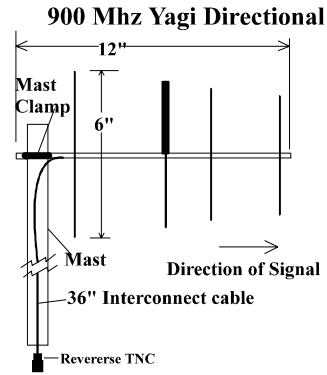

## ***Installing the Hardware***

With the unit powered off, attach the RP-TNC antenna to the antenna connector.

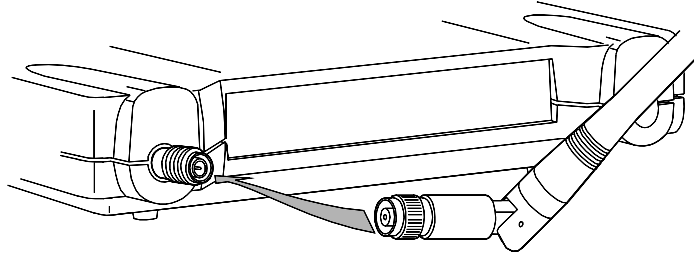

*Do not over-tighten when connecting, finger-tight is sufficient. Once connected, make sure the antenna is positioned vertically to achieve an omni-directional pattern.*

Attach the console port cable to the EIA-232-E port and the other end of the cable to the serial port on a terminal, or PC running a terminal emulation program.

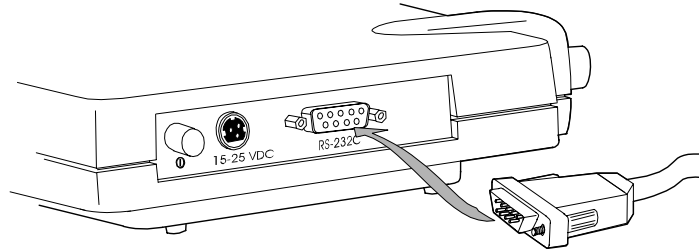

**If using Thinnet cabling**, attach the cable to each end of a BNC T-connector, if applicable, then slide the T-connector onto the unit's 10Base2 BNC connector.

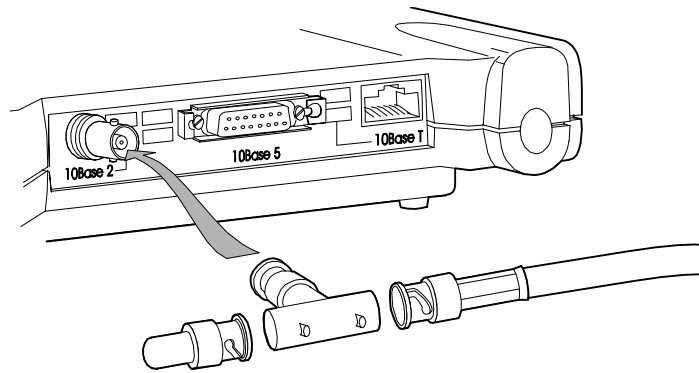

*If the Access Point is at the end of the Ethernet cable, a 50-ohm terminator must be installed on the open end of the T-connector.*

**If using 10Base5 (Thicknet) cabling**, attach the Transceiver Connector to the unit's 10Base5 AUI Port. Slide the locking mechanism in place. The other end of the Transceiver drop cabling should connect to an External Transceiver.

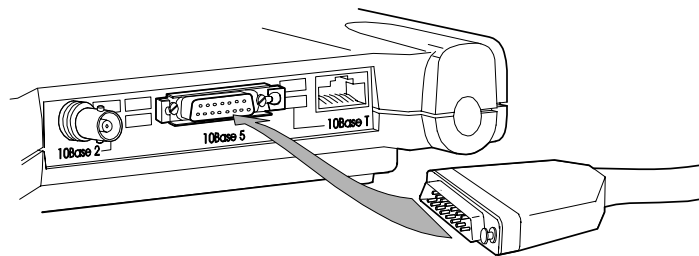

**If using 10BaseT (Twisted Pair) cabling, plug the RJ-45 connector into the 10BaseT (Twisted Pair) socket and connect the other end of the cabling to a Twisted Pair hub or concentrator.**

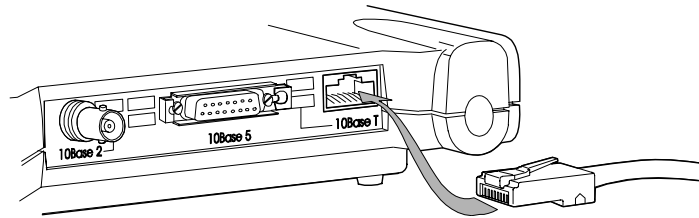

Insert the small plug on the end of the AC/DC Power Pack Cord into the 12-18VDC port, then plug the AC/DC power pack into an electrical outlet.

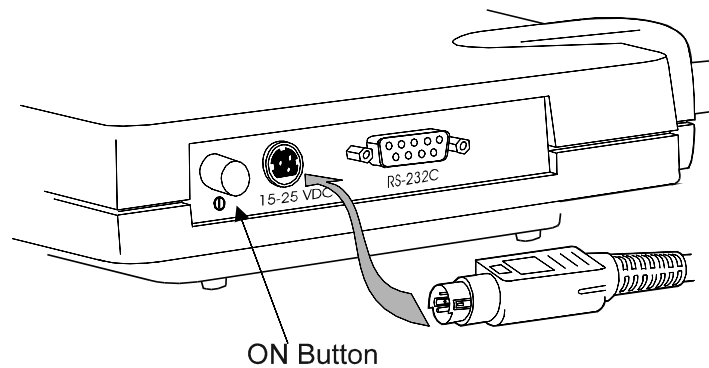

Power-on the Access Point by pushing the ON button.

When power is initially applied to the Access Point, all three Indicators will flash yellow, red and then green, in sequence, to test the functionality of the Indicators. The Power-On Self Test follows. If any power-on test fails, the Status Indicator will go solid red and the unit will stop functioning.

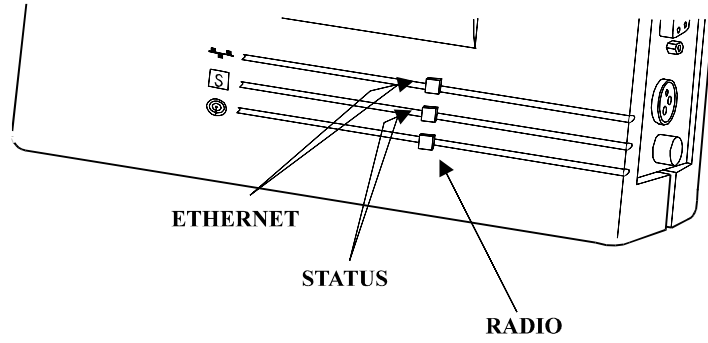

## ***Configuring the Access Point***

To configure the Access Point to communicate with end nodes or repeaters, you must first use the Console Port to set the following parameters - SID, Bitrate/Frequency (or Channel), Root Mode. If you set an IP address now, you will be able to Telnet to the unit.

The Console Port can be accessed directly by connecting the Access Point to an EIA-232-E terminal emulation program or by running a Telnet session from a remote on a network.

### ***Console Port***

To start the Console Port, set the EIA-232-E terminal (or PC running a terminal emulation program) to *9600 Baud, No-Parity, 8 data bits and 1 stop bit*.

Power-on the Access Point and the terminal and then type Yes or No when prompted for the ANSI or Teletype command.

The Console Port consists of a main menu and a series of sub-menus containing the configuration parameters. Simply type the name of the parameter or the menu number and then press ENTER.

### ***Telnet Session***

Telnet sessions can be disabled under *Configuration Console Telnet Off*

Before starting a Telnet session to a remote Access Point, you must first assign the unit an IP Address.



From the Main Menu, type *Configuration Ident Inaddr* and then type the applicable address.

### ***System Identifier (SID)***

The SID is a unique identifier that is attached to each packet sent out over the radio. You must make sure that the Access Point is set with the ***same SID as the other nodes on the network with which you would like to share RF communication.***

You can either set your own SID or ask the unit to pick a random value for you. This is probably the best way to pick a SID as there is less chance of conflicting with other networks that may be in radio range. You may use only one unit to pick the random value. ***This same value must be used on all other devices on this system.***

At the Console Port, type *Configuration Radio SID* and then enter an even HEX number not exceeding 6 digits, or select *random* if you want the Access Point to pick the SID.

### ***Bitrate/Frequency (2000 Series/2.4 GHz Models)***

The bit rate and frequency must match those of other nodes on the RF network. The default bit rate is the highest available, and the default frequency is the center frequency. You can accept these defaults or change them as follows. Type *Bitrate* and then type the applicable bit rate from the choices shown. Type *Frequency* and then type the applicable frequency from the choices shown.

### ***Channel (1000 Series/900MHz Models)***

The channel must match that of other nodes on the RF network. The default channel is the center frequency with the highest data rate. Since each channel is matched to a bit rate, changing the channel will also change the bit rate. Type *Channel* and then type the applicable channel from the choices shown. See *Appendix D* in the *AP1000-E/AP2000-E Technical Reference Manual* for more details.

### ***Root Mode***

If your Access Point is serving as a repeater (no connections to the backbone) you should set root mode to "Off" as follows:

Type *Configuration-Radio-Root* and then type "Y" in response to the argument prompt.

### ***Verifying Registration***

Once you have configured your Access Point with the correct parameters and the end nodes are correctly configured, RF communication may begin. The Radio Indicator will flash "green" indicating RF data traffic. The Status Indicator will be "solid green" indicating that one or more nodes have registered to the unit.

## ***Where to Go from Here***

Please ask your Aironet representative for the *AP1000-E/AP2000-E Technical Reference Manual*.

In the *Technical Reference Manual*, you can learn more details about your Aironet unit and ARLAN software. Use the instructions in this reference to view statistics and perform system diagnostics.

## ***Technical Support***

### ***Shipping Address***

Aironet Wireless Communications, Inc.  
367 Ghent Road, Suite 300  
Fairlawn, Ohio 44333

### ***Communications***

Telephone - (800) 705-5555  
Fax - (330) 664-7990  
e-mail - techsupp@aironet.com

### ***Web Site***

<http://www.aironet.com>

## *Other AIRONET Products*

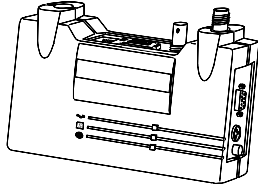

**Ethernet Access Point**

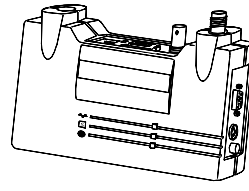

**Ethernet Bridge**

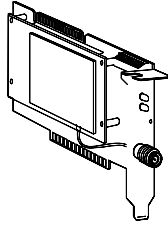

**ISA PC Card**

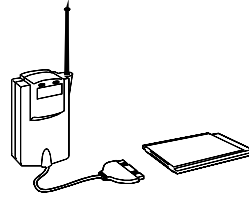

**PCMCIA Adapter**

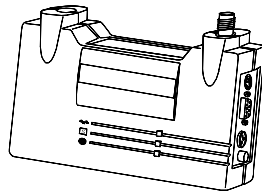

**Token Ring Access Point**

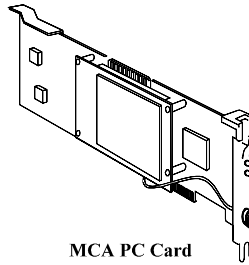

**MCA PC Card**

